









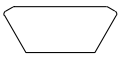

1 From the chart below, locate the shape and the size of the worksurface and the style of the leg to be assembled to it. Refer to the Figure indicated for the recommended Base Plate locations:

WORKSURFACE SHAPE	WORKSURFACE SIZE	NUMBER OF LEGS REQUIRED	SEE FIGURE
	18 x 48 18 x 54 18 x 60	4	"A"
	24 x 48 24 x 54 24 x 60 30 x 48 30 x 54 30 x 60	4	"B"
	24 x 48 24 x 54	4	"C"
	24 x 60	4	"C"
	24 x 60	4	"D"
	30 x 60	4	"E"
	24 x 48 24 x 60	4	"F"
	24 x 48 30 x 60	3	"G"
	36 x 36	4	"H"
	36 x 36 42 x 42 48 x 48	4	"I"
	36 42 48	4	"J"

Assembly Instructions

Static/Mobile
2" Column Leg

Recommended Tools

- Tape measure
- Pencil
- Power drill
- Phillips screw bit
- Level

Package Contents	Qty.
• Static Column Leg	1
or Mobile Column Leg	1
• #10 x 1" Pan Head Screw	8

NATIONAL
Furniture with Personality™

Telephone 800.482.1717
Fax 812.482.8800
www.NationalOfficeFurniture.com

Part #2234978
Rev.E

Printed in U.S.A.
© 2017 Kimball International, Inc.

Proper product installation, in accordance with these instructions, is the responsibility of the installing agent. If you have any questions concerning these instructions, please call National Customer Care Teams.

Assembly Instruction

**Static/Mobile
2"Column Leg**

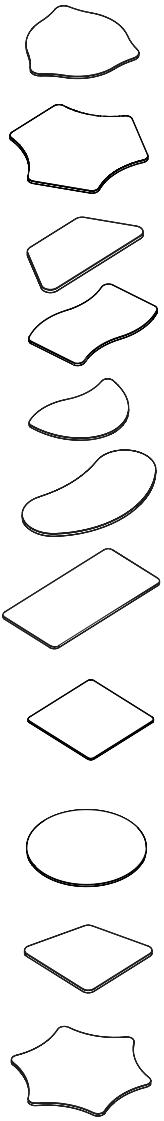
WORKSURFACE SHAPE	WORKSURFACE SIZE	LEG STYLE
	MANEUVER	
	ALL SIZES	<p style="text-align: center;">Column LEGS</p> <p style="text-align: center;">PLACE COLUMN LEGS IN PRE BORED HOLES</p>

Assembly Instructions

2" Static/Mobile
Column Leg

Figure A

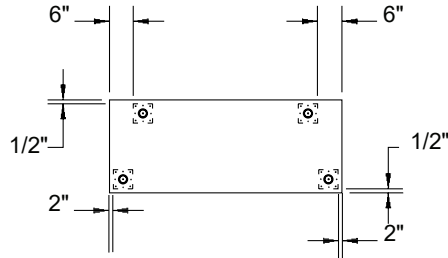

Figure B

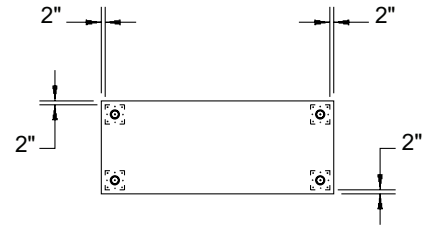

Figure C

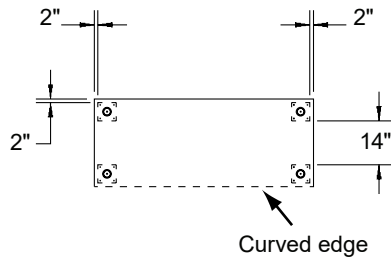

Figure D

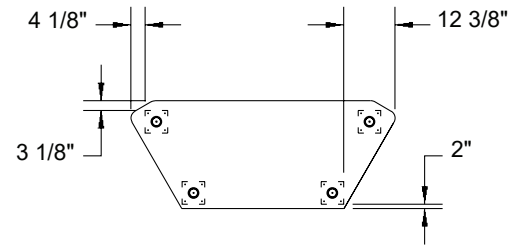

Figure E

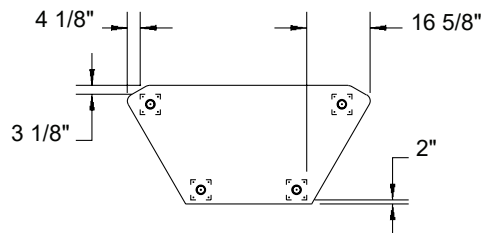
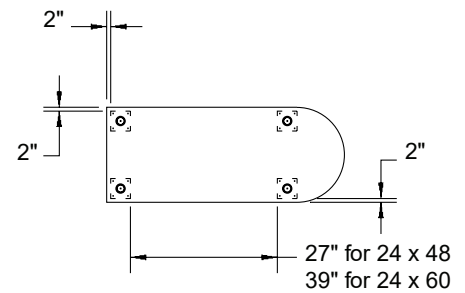

Figure F



Proper product installation, in accordance with these instructions, is the responsibility of the installing agent. If you have any questions concerning these instructions, please call National Customer Care Teams.

Assembly Instructions

2"Static/Mobile
Column Leg

2

Place the worksurface face down on a clean, solid surface or floor. Position the Mounting Plate as described on the previous page. Attach the Mounting Plate to the worksurface using the eight (8) #10 x 1" Pan Head Screws provided. Repeat this procedure for each leg required (Figure J).

Figure J

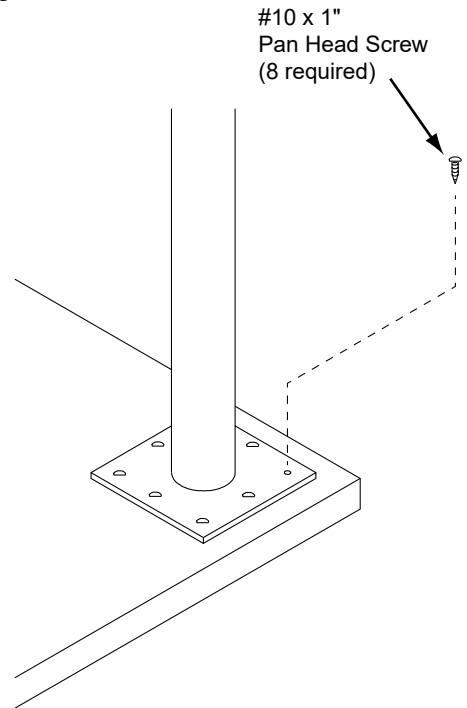

3

Static Column Leg only: Level table as required by rotating the Adjustable Glide counterclockwise to extend the glide and raise the worksurface (Figure K).

Figure K

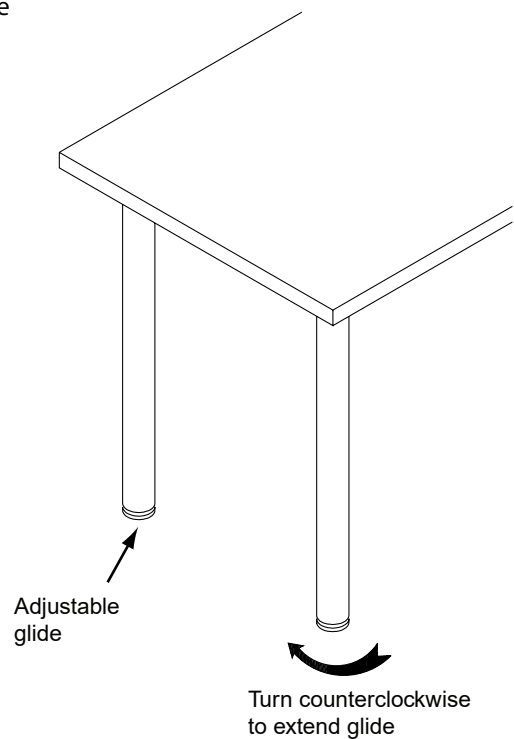

Proper product installation, in accordance with these instructions, is the responsibility of the installing agent. If you have any questions concerning these instructions, please call National Customer Care Teams.