

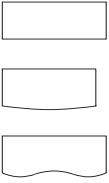

**1**

From the chart below, locate the shape and size of the worksurface and the style of the leg to be assembled to it. Refer to the Figure indicated for the recommended Base Plate locations:-

WORKSURFACE SHAPE	WORKSURFACE SIZE	LEG STYLE	SEE FIGURE
	24 x 48 24 x 54 24 x 60 24 x 66 24 x 72	"C"	"A"
		"T"	"B"
	24 x 48 24 x 60	"C"	"D"
		"T"	"E"
	24 x 60	"C"	"F"
		"T"	"G"
WORKSURFACE SHAPE	WORKSURFACE SIZE	LEG STYLE	
<b>MANEUVER</b>			
	<b>ALL SIZES</b>	<b>C LEGS</b>  <b>PLACE C LEGS IN PRE BORED HOLES</b>	

**Conference and Training Solutions**  
C Leg / T Leg

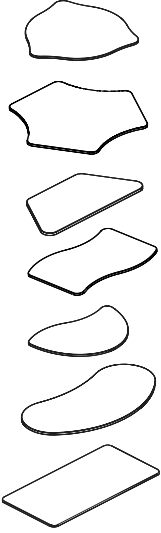
**Recommended Tools**

- Screw Gun
- Tape Measure
- Power drill with Phillips Bit
- Pencil

<b>Package Contents</b>	<b>Qty.</b>
• #10 x 1" Panhead Screws	Per Order

**NATIONAL** | Furniture with Personality

Telephone 800.482.1717  
 Fax 812.482.8800  
 www.nationalofficefurniture.com

Part #2818605  
 Rev,B

Printed in U.S.A  
 © 2017 Kimball International, Inc.

Proper product installation, in accordance with these instructions, is the responsibility of the installing agent. If you have any questions concerning these instructions, please call National Customer Service.

# Assembly Instruction

## Conference and Training Solutions C Leg / T Leg

Figure A

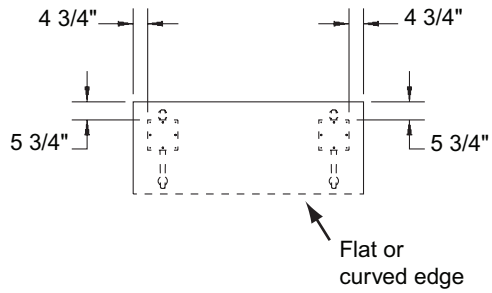

Figure B

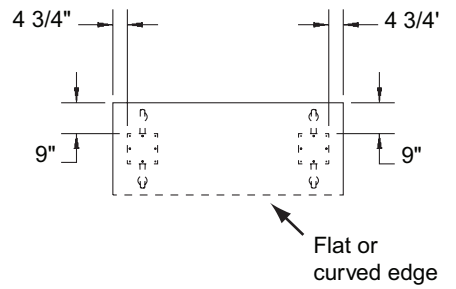

Figure D

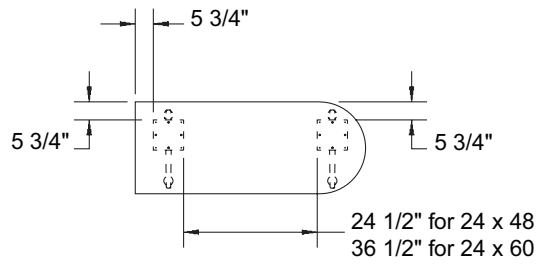

Figure E

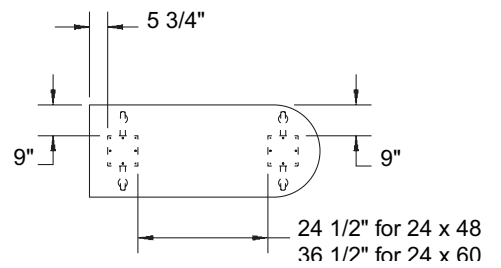

Figure F

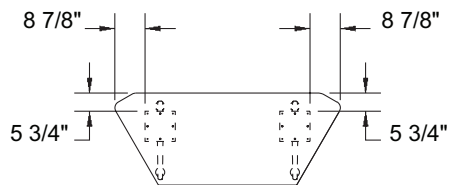
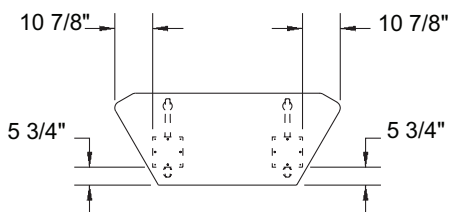
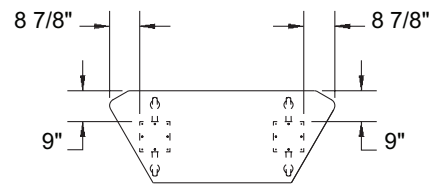

Figure G



## Assembly Instruction

### Conference and Training Solutions C Leg / T Leg

**2**

Place the worksurface face down on a clean, solid surface of floor. Position the Base Plate as described on the previous pages. Attach the Base Plate to the worksurface using the eight (8) #10 x 1" Pan Head Screws provided (Figure J).

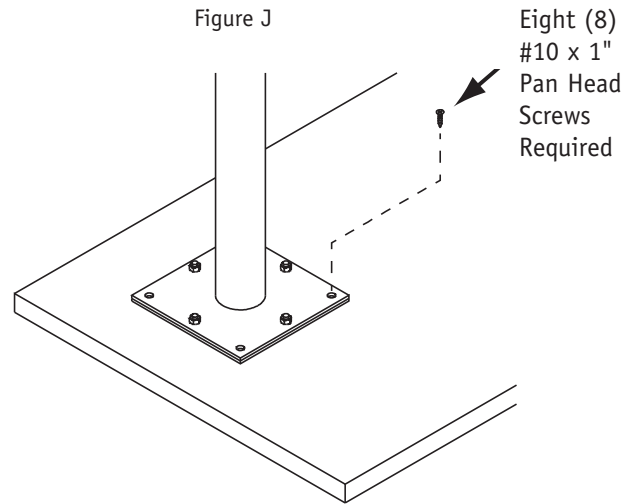

**3**

To remove the entire leg assembly, remove the eight (8) #10 x 1" Pan Head Screws in Step number two (2).