

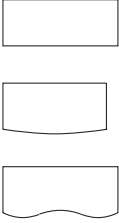



1

From the chart below, locate the shape and size of the worksurface and the style of the leg to be assembled to it. Refer to the Figure indicated for the recommended Base Plate locations:-

WORKSURFACE SHAPE	WORKSURFACE SIZE	LEG STYLE	SEE FIGURE
	24 x 48 24 x 54 24 x 60 24 x 66 24 x 72	"C"	"A"
		"T"	"B"
	30 x 48 30 x 54 30 x 60 30 x 66 30 x 72	"C"	"A"
		"T"	"C"
	24 x 48 24 x 60	"C"	"D"
		"T"	"E"
	24 x 60	"C"	"F"
		"T"	"G"
	30 x 60	"C"	"H"
		"T"	"I"

Conference and Training Solutions

C Leg / T Leg

Recommended Tools

- Screw Gun
- Tape Measure
- Power drill with Phillips Bit
- Pencil

Package Contents

- #10 x 1" Panhead Screws

Qty.

Per Order

NATIONAL | Furniture with Personality™

Telephone 800.482.1717
 Fax 812.482.8800
www.nationalofficefurniture.com

Part #2106944
 Rev,-

Printed in U.S.A
 © 2008 Kimball International, Inc.

Proper product installation, in accordance with these instructions, is the responsibility of the installing agent. If you have any questions concerning these instructions, please call National Customer Service.

Assembly Instruction

Conference and Training Solutions C Leg / T Leg

Figure A

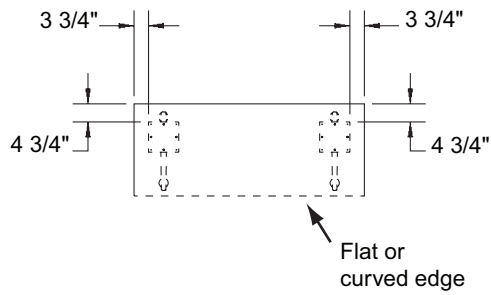

Figure B

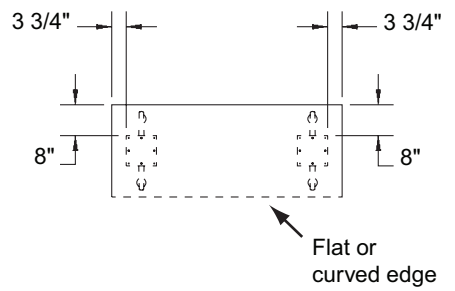

Figure C

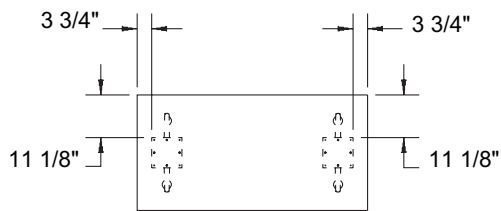

Figure D

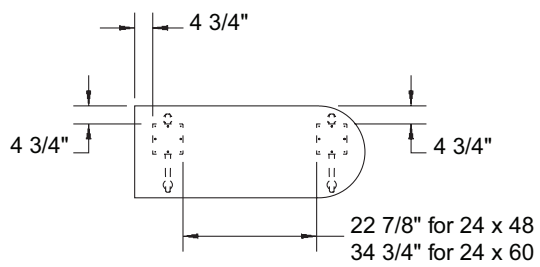
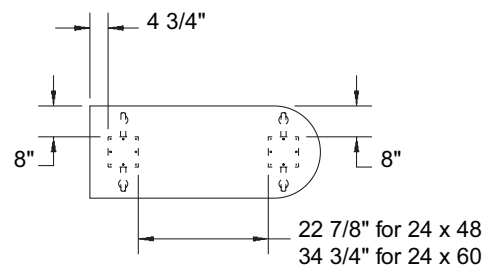

Figure E



Assembly Instruction

Conference and Training Solutions C Leg / T Leg

Figure F

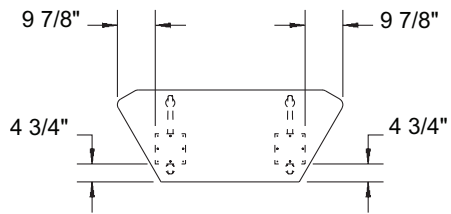
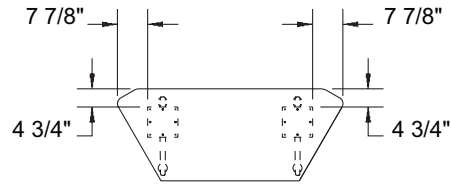

Figure G

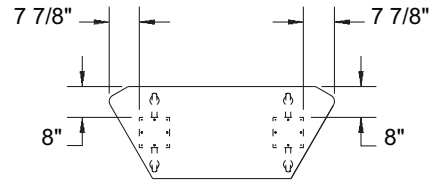

Figure H

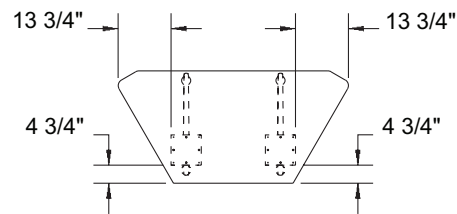
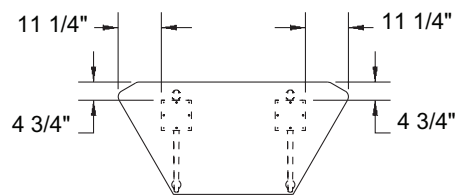
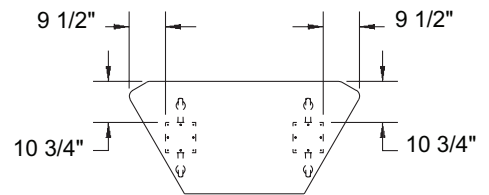

Figure I



Assembly Instruction

Conference and Training Solutions C Leg / T Leg

2

Place the worksurface face down on a clean, solid surface of floor. Position the Base Plate as described on the previous pages. Attach the Base Plate to the worksurface using the four (4) #10 x 1" Pan Head Screws provided (Figure J).

Figure J

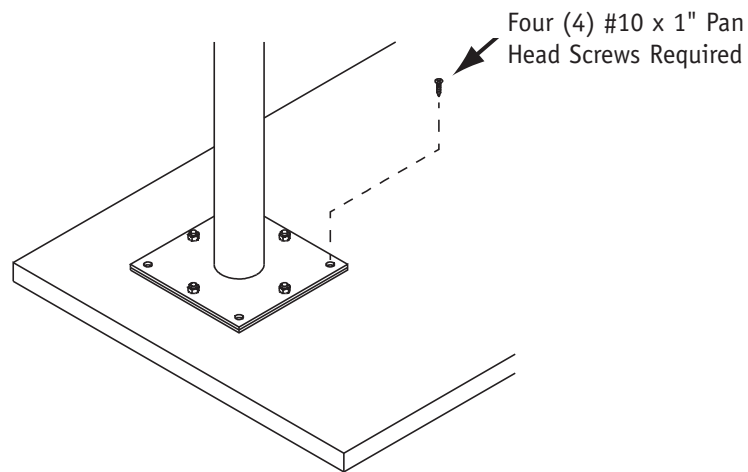

2

To remove the entire leg assembly, remove the four (4) #10 x 1" Pan Head Screws in Step number two (2).

Proper product installation, in accordance with these instructions, is the responsibility of the installing agent. If you have any questions concerning these instructions, please call National Customer Care Teams.