

---

# EXHIBIT

## WALL RAIL SOLUTION

Product Specifications	304
Production Options	306
Product Overview	308
Application Guidelines	309
Product Pages	310



## PRODUCT SPECIFICATIONS

### HORIZONTAL WALL RAIL AND FACEPLATE

- Wall rail and faceplate are a powder coated aluminum extrusion
- Available in lengths of 72" and 144"
- Wall rails come in sets of 1 or 2 and include faceplate and alignment brackets
- Wall rails can also be ordered without faceplates
- When attaching worksurfaces to the wall rail without the use of tack board, marker board, or slat wall inserts, wall rail can be ordered without the faceplate
- Faceplate snaps onto wall rail to secure marker board, tack board and slat wall inserts in place; Inserts can be removed or replaced without removing wall rail
- Faceplate conceals alignment brackets, fasteners and provides a clean aesthetic look
- Wall rail is mounted horizontally providing tie in to appropriate load bearing studs
- Alignment bracket is required to align 2 adjacent sections of wall rail and is included with wall rails
- Alignment bracket is hidden from view once installation is complete
- Wall rails can be cut to size in the field
- WaveWorks and Epic worksurfaces can be attached to wall rails with worksurface brackets
- Worksurfaces that are attached to the wall rail can be ordered with or without a wire manager; Worksurfaces with a wire manager have a flexible PVC trough that allows cords and cables to be routed along the back edge or sides of worksurface

### MARKER BOARD INSERTS

- Marker board inserts have erasable writing surface and are available in HPL or magnetic porcelain models
- Marker board inserts are available in white only
- HPL marker board and tack board insert models can be scribed in field
- Marker board, tack board and slat wall inserts include 2 trim channels

### TACK BOARD INSERTS

- Tack board insert is available in fabric, see page 306 for fabric options
- Shaded rectangle portrays a railroaded tack board

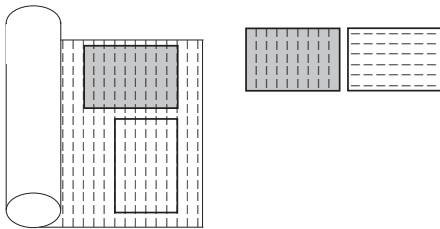

### SLAT WALL INSERTS

- Slat wall inserts are powder coated aluminum
- Slat wall inserts offer flexibility in placement of work tools; Combo slat wall inserts offer a slat wall insert combined with a tack board insert providing a multi-functional area and is an economical alternative when overhead storage will be used

### ORGANIZER SHELF INSERTS

- Veneer organizer shelf inserts are plain sliced slipmatched cherry (Amber, Autumn, Mocha, Truffle) or maple veneer (Brighton, Caramel, Honey, Natural), plain sliced bookmatched walnut veneer (Clear Walnut, Cordovan, Judicial), quarter cut walnut veneer (Almond, Portobello, Sable), or quarter cut oak veneer (Sonoma).
- When specifying Clear Walnut, a clear coat finish, the natural wood characteristics of walnut veneer are visible. These characteristics include, but are not limited to, color and woodgrain variation
- Finish is a water-based, high performance wood finish that meets or exceeds indoor air quality standards. This proprietary finish is virtually VOC-free, has remarkable durability and allows the beauty of wood to show through
- Surfaces feature a semi-open pore matte finish

### EXHIBIT TV MOUNT INSERT

- Fabric insert is not tackable; see page 306 for fabric options
- Single TV Mount included with laminate, veneer, and fabric inserts
- Dual TV Mount available as an option on 60" inserts for additional upcharge

### TRIM CHANNELS

- Quantity of 2 is standard with each board/insert
- Available in powder coat paint or fabric
- Provides an expansion joint, vertical cable manager attachment and compensates for out-of-plumb walls
- Trim Channels can be ordered separately for boards/inserts that have been scribed in the field

### FULL END TRIM

- Full end trim is steel and powder coated
- Full end trim finishes the end of a run and connects the top and bottom wall rail

**SINGLE END CAP**

- Single end cap is steel and powder coated
- Single end cap finishes the end of a single wall rail by capping off the wall rail, perfect for when a wall rail is used without inserts and a faceplate

**VERTICAL CABLE MANAGER**

- Vertical cable manager attaches between the insert and trim channel
- Conceals and allows for power cords to be managed and routed from overhead to outlet

**VERTICAL CABLE MANAGER FOR TV MOUNT INSERT**

- Vertical Cable Manager attaches to the Exhibit TV Mount Insert
- Conceals and allows for power cords to be managed and routed from TV to outlet

**WORKSURFACE BRACKETS**

- Exhibit worksurface brackets attach worksurfaces to lower wall rail
- A worksurface bracket is required every 48" along back edge of worksurface
- Worksurface bracket is anodized aluminum

**PLANNING TIPS**

- Wall rails can be mounted at any height if not utilizing with WaveWorks or Epic vertical storage units
- Consider the worksurface load when planning support; For worksurfaces that will hold office equipment, such as printers and copiers, additional support other than standard worksurface brackets is recommended
- Undersurface storage and pedestals satisfy both storage and support needs
- Reconfiguring existing worksurfaces may require new supports or brackets
- When worksurfaces meet end-to-end, a support panel or undersurface storage is required for additional support of the front edge
- Perpendicular worksurfaces can use flat brackets and worksurface brackets to provide adequate support from 1 surface to the other at the worksurface joint
- Worksurface brackets and supports can be positioned anywhere along the worksurface without the limitations of pre-drilled or predetermined locations
- Knife rim adds 1½" per side to worksurface depth. Knife rim is not recommended on lower storage as it affects user's kneespace
- Consider where you specify a worksurface with Worksurface wire manager. When attached to Exhibit lower wall rail, do not use at the end of run for a cleaner aesthetic
- Tack boards may be field scribed to match Epic knife rim worksurface depth

**DIMENSION KEY**

D	Depth
W	Width
H	Height
A	Overhang: Approach Side
KW	Kneespace Width

# CONFIGURATION OPTIONS - EXHIBIT

## WALL RAIL/FACEPLATE/ SLAT WALL INSERT PAINT COLORS

- 423 Concrete
- 462 Cinder
- 463 Iron
- 501 Platinum Metallic
- 503 Satin Nickel Metallic

## TRIM CHANNEL PAINT COLORS

- 401 White
- 423 Concrete
- 462 Cinder
- 463 Iron
- 501 Platinum Metallic
- 503 Satin Nickel Metallic

## END TRIM/END CAP PAINT COLORS

- 423 Concrete
- 462 Cinder
- 463 Iron
- 501 Platinum Metallic
- 503 Satin Nickel Metallic

## WORK TOOLS (METAL)

- 423 Concrete
- 462 Cinder
- 463 Iron
- 501 Platinum Metallic
- 503 Satin Nickel Metallic

## TACK BOARD INSERT/TRIM CHANNEL/WIRE MANAGER FABRIC OPTIONS

Dune (Grade A)  
100% Polyester

- 8600 Drift
- 8601 Windblown
- 8602 Erosion
- 8603 Haze
- 8604 Kamelos
- 8606 Pebble
- 8607 Gecho
- 8608 Nectar
- 8610 Clear Sky
- 8614 Basin
- 8615 Raven
- 8620 Darkness
- 8621 Golden

Repetition (Grade A)  
100% Pre-Consumer  
Recycled Polyester

- 3700 Ash
- 3703 White
- 3705 Willow
- 3709 Java
- 3713 Stainless
- 3715 Almond
- 3721 Reed
- 3744 Tawny
- 3775 Grey Green

COM (Grade B)

Pact (Grade B)  
65% Pre-Consumer Recycled Polyester,  
35% Post-Consumer Recycled Polyester

- |               |                 |
|---------------|-----------------|
| 25401 Aloe    | 25413 Midnight  |
| 25402 Azure   | 25414 Nectar    |
| 25403 Calla   | 25415 Patina    |
| 25404 Coastal | 25416 Putty     |
| 25405 Delft   | 25417 Roast     |
| 25406 Dove    | 25418 Roma      |
| 25407 Dragon  | 25419 Rubine    |
| 25408 Eureka  | 25420 Sketch    |
| 25409 Fern    | 25421 Tanzanite |
| 25410 Harbour | 25422 Taupe     |
| 25411 Lily    | 25423 Toasty    |
| 25412 Lime    |                 |

## EXHIBIT TV MOUNT INSERT OPTIONS

- TS Single TV Mount, Front
- TD Dual TV Mount, Front  
(\$716 list upcharge)

## EXHIBIT COMPONENTS

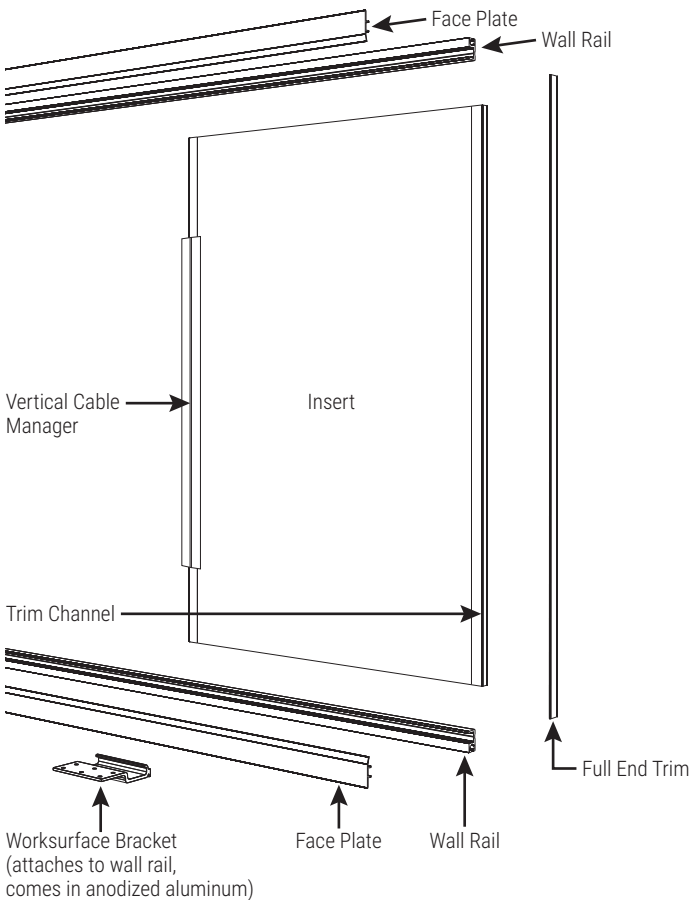

## SH6 ORGANIZER SHELF HEIGHT 36"/37"/48"/49" HIGH MODELS

- A Align with 13H Overhead
- B Align with 18H Overhead
- C Align with 30H Overhead\*  
\*48"/49" high models only
- D Align with SH1 top shelf

EXHIBIT

**WOOD FINISHES  
(ORGANIZER SHELF  
INSERT)**

- AC Autumn
- AD Almond
- CL Caramel
- CW Cordovan
- DW Judicial
- EW Clear Walnut\*\*
- HN Honey
- IM Brighton
- MC Amber
- MH Mocha
- NM Natural
- PB Portobello
- SM Sonoma
- TF Truffle
- 792 Sable

**LAMINATE COLORS  
(ORGANIZER SHELF INSERT)**

**WOODGRAIN LAMINATE**

- AC2 Autumn 2
- AD Almond
- ADH Almond Horizontal
- CL Caramel
- CW Cordovan
- DW Judicial
- HN2 Honey 2
- IM Brighton
- MC Amber
- MH Mocha
- NM Natural
- TF Truffle
- PB Portobello
- PBH Portobello Horizontal
- PT Portico\*
- PTH Portico Horizontal\*
- SK Skyline\*
- SKH Skyline Horizontal\*
- SM Sonoma
- SMH Sonoma Horizontal
- 792 Sable
- 792H Sable Horizontal
- 793 Acorn\*\*

**SOLID LAMINATE**

- 405 Designer White
- 419 Wallaby
- 425 Shadow
- 440 Cloud
- 461 Graphite
- 462 Cinder
- 478 Platinum Grey
- 488 Frosty White
- 491 Designer White Linear
- 491H Designer White Linear Horizontal
- 492 Cinder Linear
- 492H Cinder Linear Horizontal

\*Not available on laminate/wood models  
 \*\*Acorn is the laminate complement to Clear Walnut finish

**GALLERY LAMINATE**

- Grade 1 – 5% upcharge
  - G1001 Citadel
  - G1011 Pepperdust
  - Grade 2 – 6% upcharge
  - G1002 Planked Raw Oak
  - G1003 Evening Notte
  - G1004 Kirsche
  - G1005 Midnight Run
  - G1006 Sepia Walnut
  - G1007 Serotina
  - G1008 Timeless
  - G1009 White Nebbia
  - G1012 Phantom Ecru
- See page 21 for Gallery program details and upcharges



# EXHIBIT

## OVERVIEW

Exhibit is a series consisting of a horizontal rail, marker board, tack board, and slat wall inserts, and work tools.

Exhibit can be used in numerous applications. Here are a few examples of how it can be used with National Office Furniture products.

## EXHIBIT WITH WAVEWORKS AND EPIC MODELS

The Exhibit rail is a horizontal rail that attaches to walls to accommodate WaveWorks and Epic workspaces and components. Attaching workspaces directly to the wall rail allows the reduction of modesty panels and opens the space for a clean aesthetic.

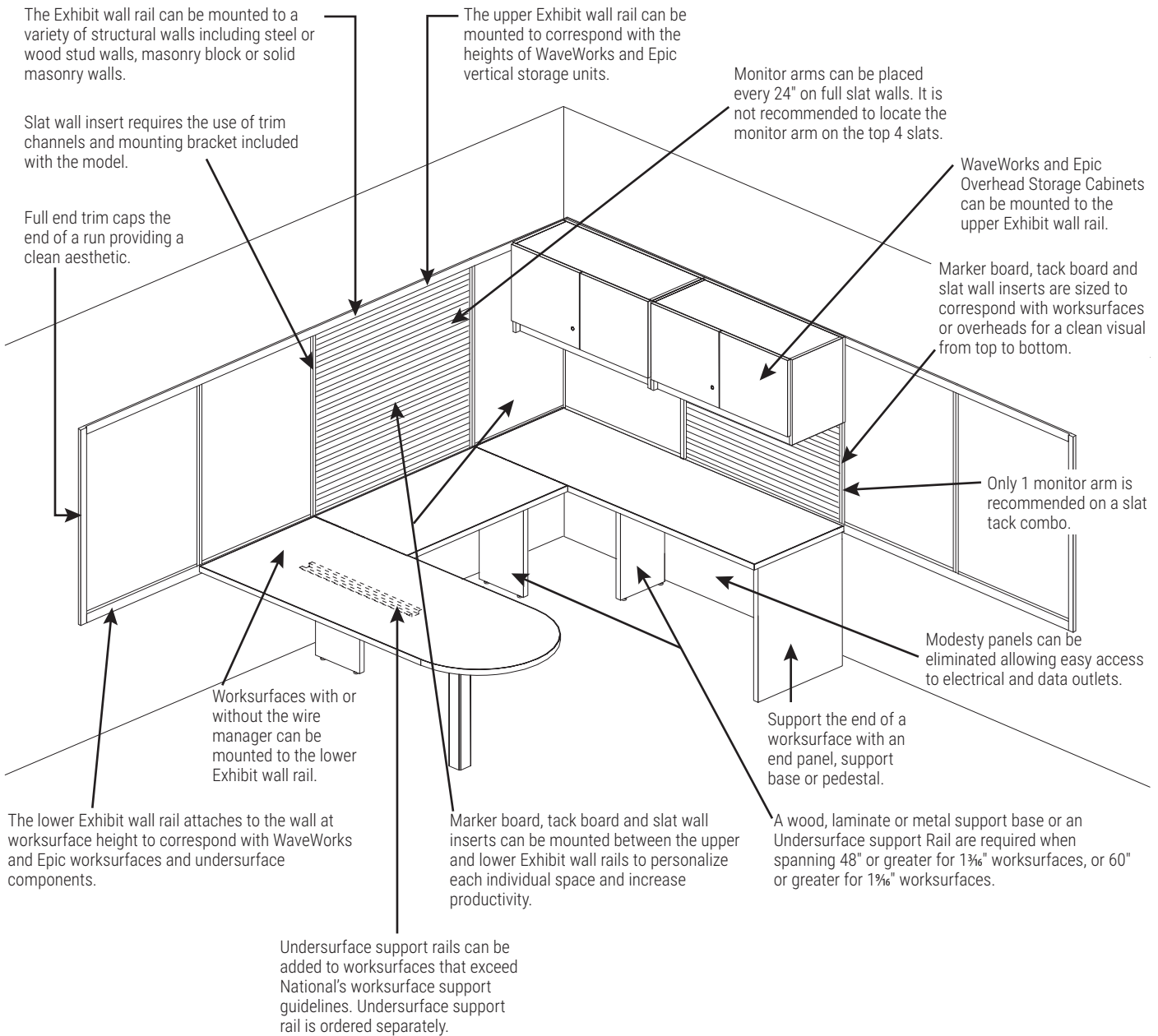

EXHIBIT

## APPLICATION GUIDELINES

### FASTENERS

- Fasteners must tie in directly to the substructure of a structural wall for proper attachment of Exhibit wall rail. National defines a structural wall as a load bearing wall constructed of materials such as poured concrete, concrete block, or studs

### MINIMUM REQUIREMENTS

- Wood studs must be nominal 2" x 4" minimum
- Metal studs must be "C" channel, 20 gauge minimum thickness
- Metal or wood studs must be on centers no greater than 24" and have a maximum height of 14' restrained at floor and ceiling
- Interior walls must be designed to resist not less than a force of 5 lbs. per sq. ft. applied perpendicular to the wall. The deflection of such walls under a load of 5 lbs. per square foot shall not exceed  $\frac{1}{200}$  of the span for walls with brittle finishes and  $\frac{1}{200}$  of the span for walls with flexible finishes (per International Building Code sections 1604.4 and 1607.13)
- Exhibit wall rail may not extend more than 6" beyond the last solid attachment point
- Minimum width of Exhibit wall rail that can be attached to a wall is 16" mounted to studs 16" apart
- If an overhead is being mounted, the minimum width for Exhibit is 30" with the Exhibit wall rail being centered on studs 24" apart, so as not to extend more than 6" beyond the last solid attachment point

### RECOMMENDED FASTENERS

- Selection and purchase of the proper attachment fasteners for your wall conditions is the responsibility of the installer

Type and Size	Description
Steel Studs ( $\frac{1}{2}$ " to $\frac{3}{4}$ " drywall)	
Hilti® Toggler® anchor toggle bolts, $\frac{1}{4}$ "-20 x 2" grade 5 bolts	
Wood Studs ( $\frac{1}{4}$ " to $\frac{1}{2}$ " drywall)	
Meets or exceeds ANSI/ASME B18.6.4 and SAE J933.	
Pan head sheet metal screw	10-2 PHPMS
Solid Masonry	
Crown Bolt lag shields $\frac{1}{4}$ " x $1\frac{1}{2}$ "	
Buildex Tapcon concrete anchor screw $\frac{1}{4}$ " x $2\frac{3}{4}$ "	
Masonry Block	
Hilti Toggler anchor toggle bolts, $\frac{1}{4}$ "-20 x 2" grade 5 bolts	
Crown Bolt lag shields $\frac{1}{4}$ " x $1\frac{1}{2}$ "	
Buildex Tapcon concrete anchor screw $\frac{1}{4}$ " x $2\frac{3}{4}$ "	

- Actual mounting height can be varied to meet specific needs; however, undersurface storage height must be considered
- Variations in the floor surface (peaks and valleys) should be considered, especially where horizontal placement is critical
- Exhibit wall rail extends  $\frac{1}{8}$ " from the wall. This dimensional loss should be considered when space planning for components, when Exhibit wall rails are being used on 2 or more walls of a space
- Select worksurfaces and inserts can be field scribed to fit space
- In fixed wall Exhibit applications, choose your insert height based on your specific application or height of corresponding WaveWorks vertical storage. Consider the height of the cabinet and clearance between the bottom of the overhead and the worksurface

### 34" Tall Inserts

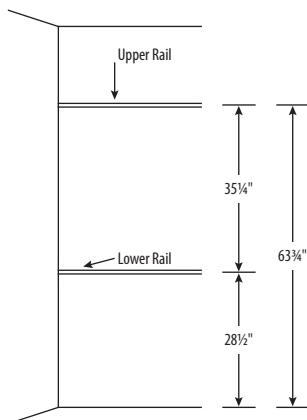

### 36" and 48" Tall Inserts

Compatible with WaveWorks and Epic 68" and WaveWorks 79" High WW Models

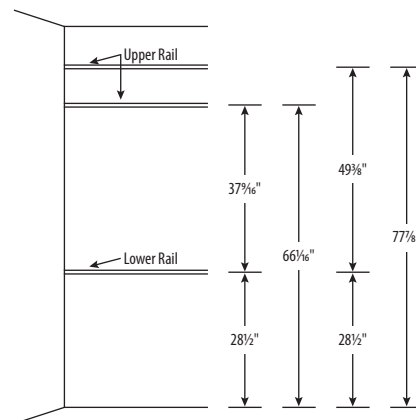

### 37" and 49" Tall Inserts

Compatible with WaveWorks 69" and 80" High WWN Models

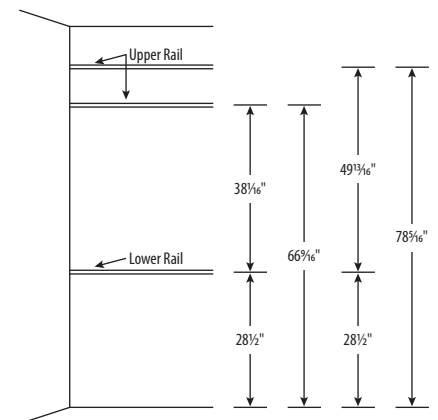

- Conference and training rooms commonly use 49" tall inserts, but with Exhibit, you can use any of the 5 heights to achieve the customer's needs.

### WALL

- Trim when using full insert

# EXHIBIT

## PRODUCT SPECIFICATIONS

- Exhibit rail can be cut to size in the field
- Alignment brackets are required to align 2 sections of Exhibit rail in line
- Exhibit mount overheads available in the WaveWorks and Epic series, see Casegoods Book 2 Price List
- For worksurface brackets, end trim and end caps see pages 352-354

## TO ORDER, SPECIFY:

1. Model Number
2. Paint Color

## SAMPLE MODEL NUMBER:

- 11N72EXFP2 462
- See pages 306-307 for all options available in Exhibit

MODEL NO./DESCRIPTION	LIST PRICE	DIMENSIONS					CARTONED CUBIC	
		D	W	H	A	KW	WEIGHT	FEET
<b>EXHIBIT WALL RAIL AND FACEPLATE</b>								
<b>WALL RAIL AND FACEPLATE</b>								
11N72EXFP2 Set of 2	\$ 287	¾	72	1¾	—	—	6 lbs.	0.7
11N144EXFP2 Set of 2	411	¾	144	1¾	—	—	12 lbs.	1.4
11N72EXFP1 Set of 1	\$ 165	¾	72	1¾	—	—	6 lbs.	0.7
11N144EXFP1 Set of 1	228	¾	144	1¾	—	—	12 lbs.	1.4

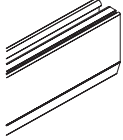

- Set of 2 includes 2 rails, 2 faceplates, and 4 alignment brackets
- Set of 1 includes 1 rail, 1 faceplate, and 2 alignment brackets
- Exhibit wall rail available in Concrete, Cinder, Iron, Platinum Metallic or Satin Nickel Metallic

## EXHIBIT WALL RAIL



<b>WALL RAIL</b>								
11N72EXP1 1 Rail/No faceplate	\$ 100	¾	72	1½	—	—	6 lbs.	0.7
11N144EXP1 1 Rail/No faceplate	145	¾	144	1½	—	—	12 lbs.	1.4

- Includes 1 wall rail and 2 alignment brackets
- Exhibit wall rail available in Concrete, Cinder, Iron, Platinum Metallic or Satin Nickel Metallic
- For use when hanging a worksurface or overhead without the use of an insert



**PRODUCT SPECIFICATIONS**

- Tack board and HPL marker board inserts can be field scribed, additional trim channels should be specified separately if creating additional inserts. Porcelain marker board inserts cannot be field scribed
- Each height of tack board, marker board, slat wall, and organizer shelf insert corresponds with a specific height of vertical storage in WaveWorks and Epic. See notation above models to see what model corresponds with appropriate height requirement
- Conference and training rooms commonly use 49" H inserts, but with Exhibit, you can use any of the 5 heights to achieve the customers needs

**TO ORDER, SPECIFY:**

1. Model Number
2. Fabric Grade
3. Fabric Color

**SAMPLE MODEL NUMBERS:**

11N1834TB B 25413  
 11N1836TB B 25413  
 11N1837TB B 25413

- See pages 306-307 for all options available in Exhibit

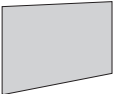
	MODEL NO./DESCRIPTION	LIST PRICE	DIMENSIONS					CARTONED WEIGHT	CUBIC FEET
			D	W	H	A	KW		
<b>TACK BOARD INSERTS</b> 	<b>34" H TACK BOARD INSERTS</b>								
			<b>GRADE A</b>	<b>GRADE B/COM</b>					
	11N1834TBA	\$ 242	\$ 283	½	18	34½	—	—	3 lbs. 0.5
	11N2434TBA	253	294	½	24	34½	—	—	4 lbs. 0.6
	11N3034TBA	296	337	½	30	34½	—	—	5 lbs. 0.8
	11N3634TBA	310	360	½	36	34½	—	—	6 lbs. 0.9
	11N4234TBA	318	368	½	42	34½	—	—	7 lbs. 1.0
	11N4834TBA	342	400	½	48	34½	—	—	8 lbs. 1.2
	11N5434TBA	388	454	½	54	34½	—	—	9 lbs. 1.3
11N6034TBA	390	456	½	60	34½	—	—	10 lbs. 1.4	
	<b>COMPATIBLE WITH WAVEWORKS 68" HIGH WW AND EPIC 68" HIGH MODELS</b>								
	<b>36" H TACK BOARD INSERTS</b>								
11N1836TBA	\$ 258	\$ 299	½	18	36½	—	—	3 lbs. 0.5	
11N2436TBA	270	311	½	24	36½	—	—	4 lbs. 0.6	
11N3036TBA	313	354	½	30	36½	—	—	5 lbs. 0.8	
11N3636TBA	331	381	½	36	36½	—	—	6 lbs. 0.9	
11N4236TBA	340	390	½	42	36½	—	—	7 lbs. 1.0	
11N4836TBA	362	420	½	48	36½	—	—	8 lbs. 1.2	
11N5436TBA	411	477	½	54	36½	—	—	9 lbs. 1.3	
11N6036TBA	414	480	½	60	36½	—	—	10 lbs. 1.4	
	<b>COMPATIBLE WITH WAVEWORKS 69" HIGH WVN MODELS</b>								
	<b>37" H TACK BOARD INSERTS</b>								
11N1837TBA	\$ 258	\$ 299	½	18	37	—	—	3 lbs. 0.5	
11N2437TBA	270	311	½	24	37	—	—	4 lbs. 0.6	
11N3037TBA	313	354	½	30	37	—	—	5 lbs. 0.8	
11N3637TBA	331	381	½	36	37	—	—	6 lbs. 0.9	
11N4237TBA	340	390	½	42	37	—	—	7 lbs. 1.0	
11N4837TBA	362	420	½	48	37	—	—	8 lbs. 1.2	
11N5437TBA	411	477	½	54	37	—	—	9 lbs. 1.3	
11N6037TBA	414	480	½	60	37	—	—	10 lbs. 1.4	

- 2 trim channels included with each tack board insert in the same fabric
- Tack board inserts can be field scribed
- Additional trim channels should be specified separately if creating additional tack board inserts
- Fabric will be railroaded

# EXHIBIT

## PRODUCT SPECIFICATIONS

- Tack board and HPL marker board inserts can be field scribed, additional trim channels should be specified separately if creating additional inserts. Porcelain marker board inserts cannot be field scribed
- Each height of tack board, marker board, slat wall, and organizer shelf insert corresponds with a specific height of vertical storage in WaveWorks and Epic. See notation above models to see what model corresponds with appropriate height requirement
- Conference and training rooms commonly use 49" H inserts, but with Exhibit, you can use any of the 5 heights to achieve the customers needs

## TO ORDER, SPECIFY:

1. Model Number
2. Fabric Grade
3. Fabric Color

## SAMPLE MODEL NUMBERS:

11N1848TB A 8600  
11N1849TB A 8600

- See pages 306-307 for all options available in Exhibit

MODEL NO./DESCRIPTION	LIST PRICE	DIMENSIONS					CARTONED WEIGHT	CUBIC FEET
		D	W	H	A	KW		
<b>TACK BOARD INSERTS (CONTINUED)</b>								
<b>COMPATIBLE WITH WAVEWORKS 79" HIGH WVN MODELS</b>								
<b>48"H TACK BOARD INSERTS</b>								
		<b>GRADE A</b>	<b>GRADE B/COM</b>					
11N1848TBA	\$ 296	\$ 346	1/2	18	48 3/8	—	—	4 lbs. 1.2
11N2448TBA	309	359	1/2	24	48 3/8	—	—	5 lbs. 1.3
11N3048TBA	360	410	1/2	30	48 3/8	—	—	6 lbs. 1.7
11N3648TBA	366	416	1/2	36	48 3/8	—	—	7 lbs. 2.0
11N4248TBA	381	431	1/2	42	48 3/8	—	—	8 lbs. 2.3
11N4848TBA	397	455	1/2	48	48 3/8	—	—	9 lbs. 2.7
11N5448TBA	453	519	1/2	54	48 3/8	—	—	10 lbs. 3.0
11N6048TBA	457	523	1/2	60	48 3/8	—	—	11 lbs. 3.3
<b>COMPATIBLE WITH WAVEWORKS 80" HIGH WVN MODELS</b>								
<b>49"H TACK BOARD INSERTS</b>								
11N1849TBA	\$ 296	\$ 346	1/2	18	48 13/16	—	—	4 lbs. 1.2
11N2449TBA	309	359	1/2	24	48 13/16	—	—	5 lbs. 1.3
11N3049TBA	360	410	1/2	30	48 13/16	—	—	6 lbs. 1.7
11N3649TBA	366	416	1/2	36	48 13/16	—	—	7 lbs. 2.0
11N4249TBA	381	431	1/2	42	48 13/16	—	—	8 lbs. 2.3
11N4849TBA	397	455	1/2	48	48 13/16	—	—	9 lbs. 2.7
11N5449TBA	453	519	1/2	54	48 13/16	—	—	10 lbs. 3.0
11N6049TBA	457	523	1/2	60	48 13/16	—	—	11 lbs. 3.3

- 2 trim channels included with each tack board insert in the same fabric
- Tack board inserts can be field scribed
- Additional trim channels should be specified separately if creating additional tack board inserts
- Fabric will be railroaded

**PRODUCT SPECIFICATIONS**

- Tack board and HPL marker board inserts can be field scribed, additional trim channels should be specified separately if creating additional inserts. Porcelain marker board inserts cannot be field scribed
- Each height of tack board, marker board, slat wall, and organizer shelf insert corresponds with a specific height of vertical storage in WaveWorks and Epic. See notation above models to see what model corresponds with appropriate height requirement
- Conference and training rooms commonly use 49" H inserts, but with Exhibit, you can use any of the 5 heights to achieve the customers needs

**TO ORDER, SPECIFY:**

1. Model Number

**SAMPLE MODEL NUMBER:**

11N2434MB

- See pages 306-307 for all options available in Exhibit

	MODEL NO./DESCRIPTION	LIST PRICE	DIMENSIONS					CARTONED WEIGHT	CUBIC FEET
			D	W	H	A	KW		
	<b>34"H MARKER BOARD INSERTS</b> <b>HPL</b>								

**COMPATIBLE WITH WAVEWORKS 68" HIGH WW AND EPIC 68" HIGH MODELS**

**36"H MARKER BOARD INSERTS**

	MODEL NO./DESCRIPTION	LIST PRICE	D	W	H	A	KW	CARTONED WEIGHT	CUBIC FEET
	<b>HPL</b>								

**COMPATIBLE WITH WAVEWORKS 69" HIGH WWN MODELS**

**37"H MARKER BOARD INSERTS**

	MODEL NO./DESCRIPTION	LIST PRICE	D	W	H	A	KW	CARTONED WEIGHT	CUBIC FEET
	<b>HPL</b>								

- HPL marker board inserts can be field scribed
- Additional trim channels should be specified separately if additional inserts are created
- Porcelain marker board inserts are magnetic
- Porcelain marker board inserts are double sided
- Specify model number only
- 2 trim channels included with each marker board insert in white to match board
- Marker board inserts available in white only

# EXHIBIT

## PRODUCT SPECIFICATIONS

- Tack board and HPL marker board inserts can be field scribed, additional trim channels should be specified separately if creating additional inserts. Porcelain marker board inserts cannot be field scribed
- Each height of tack board, marker board, slat wall, and organizer shelf insert corresponds with a specific height of vertical storage in WaveWorks and Epic. See notation above models to see what model corresponds with appropriate height requirement
- Conference and training rooms commonly use 49" H inserts, but with Exhibit, you can use any of the 5 heights to achieve the customers needs

## TO ORDER, SPECIFY:

1. Model Number

## SAMPLE MODEL NUMBER:

11N2448MB

- See pages 306-307 for all options available in Exhibit

MARKER BOARD INSERTS (CONTINUED)	MODEL NO./DESCRIPTION		LIST PRICE	DIMENSIONS					CARTONED WEIGHT	CUBIC FEET	
	HPL	PORCELAIN		D	W	H	A	KW			
	<b>COMPATIBLE WITH WAVEWORKS 79" HIGH WW MODELS</b>										
	<b>48"H MARKER BOARD INSERTS</b>										
	11N2448MB	\$ 545	11N2448MB2P	\$ 811	½	24	48¾	—	—	16 lbs.	1.3
	11N3048MB	546	11N3048MB2P	813	½	30	48¾	—	—	20 lbs.	1.7
	11N3648MB	609	11N3648MB2P	902	½	36	48¾	—	—	24 lbs.	2.0
	11N4248MB	661	11N4248MB2P	971	½	42	48¾	—	—	27 lbs.	2.3
11N4848MB	800	11N4848MB2P	1156	½	48	48¾	—	—	31 lbs.	2.7	
11N5448MB	804	11N5448MB2P	1337	½	54	48¾	—	—	34 lbs.	3.0	
11N6048MB	810	11N6048MB2P	1442	½	60	48¾	—	—	38 lbs.	3.3	
	<b>COMPATIBLE WITH WAVEWORKS 80" HIGH WWN MODELS</b>										
	<b>49"H MARKER BOARD INSERTS</b>										
11N2449MB	\$ 545	11N2449MB2P	\$ 811	½	24	48 <sup>3</sup> / <sub>16</sub>	—	—	16 lbs.	1.3	
11N3049MB	546	11N3049MB2P	813	½	30	48 <sup>3</sup> / <sub>16</sub>	—	—	20 lbs.	1.7	
11N3649MB	609	11N3649MB2P	902	½	36	48 <sup>3</sup> / <sub>16</sub>	—	—	24 lbs.	2.0	
11N4249MB	661	11N4249MB2P	971	½	42	48 <sup>3</sup> / <sub>16</sub>	—	—	27 lbs.	2.3	
11N4849MB	800	11N4849MB2P	1156	½	48	48 <sup>3</sup> / <sub>16</sub>	—	—	31 lbs.	2.7	
11N5449MB	804	11N5449MB2P	1337	½	54	48 <sup>3</sup> / <sub>16</sub>	—	—	34 lbs.	3.0	
11N6049MB	810	11N6049MB2P	1442	½	60	48 <sup>3</sup> / <sub>16</sub>	—	—	38 lbs.	3.3	

- HPL marker board inserts can be field scribed
- Additional trim channels should be specified separately if additional inserts are created
- Porcelain marker board inserts are magnetic
- Porcelain marker board inserts are double sided
- Specify model number only
- 2 trim channels included with each marker board insert in white to match board
- Marker board inserts available in white only

**PRODUCT SPECIFICATIONS**

- Each height of tack board, marker board, slat wall, and organizer shelf insert corresponds with a specific height of vertical storage in WaveWorks and Epic. See notation above models to see what model corresponds with appropriate height requirement
- Conference and training rooms commonly use 49" H inserts, but with Exhibit, you can use any of the 5 heights to achieve the customers needs
- As of April 20th, 2015, the inserts (Slat, Slat/Tack Combo, Insert Shelves, and TV Mount Inserts) will only be compatible with rails ordered on or after April 20th, 2015. If trying to use 1 of these inserts with an existing rail, please contact customer service for more information

**TO ORDER, SPECIFY:**

1. Model Number
2. Paint Color

**SAMPLE MODEL NUMBER:**

11N2434SW 462

- See pages 306-307 for all options available in Exhibit

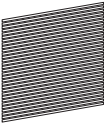
	MODEL NO./DESCRIPTION	LIST PRICE	DIMENSIONS					CARTONED WEIGHT	CUBIC FEET
			D	W	H	A	KW		
 <p><b>SLAT WALL INSERTS</b></p>	<b>34"H FULL SLAT</b>								
	11N2434SW	\$ 1168	½	24	34¾	—	—	45 lbs.	1.2
	11N3034SW	1174	½	30	34¾	—	—	57 lbs.	1.4
	11N3634SW	1343	½	36	34¾	—	—	69 lbs.	1.7
	11N4234SW	1344	½	42	34¾	—	—	79 lbs.	2.0
	11N4834SW	1490	½	48	34¾	—	—	91 lbs.	2.3
<b>COMPATIBLE WITH WAVEWORKS 68" HIGH WW AND EPIC 68" HIGH MODELS</b>									
<b>36"H FULL SLAT</b>									
11N2436SW	\$ 1185	½	24	36¾	—	—	48 lbs.	1.2	
11N3036SW	1191	½	30	36¾	—	—	60 lbs.	1.4	
11N3636SW	1358	½	36	36¾	—	—	72 lbs.	1.7	
11N4236SW	1360	½	42	36¾	—	—	82 lbs.	2.0	
11N4836SW	1513	½	48	36¾	—	—	94 lbs.	2.3	
<b>COMPATIBLE WITH WAVEWORKS 69" HIGH WWN MODELS</b>									
<b>37"H FULL SLAT</b>									
11N2437SW	\$ 1185	½	24	37	—	—	48 lbs.	1.2	
11N3037SW	1191	½	30	37	—	—	60 lbs.	1.4	
11N3637SW	1358	½	36	37	—	—	72 lbs.	1.7	
11N4237SW	1360	½	42	37	—	—	82 lbs.	2.0	
11N4837SW	1513	½	48	37	—	—	94 lbs.	2.3	
<b>COMPATIBLE WITH WAVEWORKS 79" HIGH WW MODELS</b>									
<b>48"H FULL SLAT</b>									
11N2448SW	\$ 1397	½	24	48¾	—	—	63 lbs.	1.6	
11N3048SW	1405	½	30	48¾	—	—	80 lbs.	1.9	
11N3648SW	1605	½	36	48¾	—	—	97 lbs.	2.0	
11N4248SW	1607	½	42	48¾	—	—	111 lbs.	2.2	
11N4848SW	1785	½	48	48¾	—	—	128 lbs.	2.5	

- 2 trim channels included with each slat wall insert in corresponding color to match slat
- Slat wall insert requires the use of trim channels and mounting bracket included with the model
- Slat wall should only be used with National certified work tools and monitor arms; reference pages 355-358

# EXHIBIT

## PRODUCT SPECIFICATIONS

- Each height of tack board, marker board, slat wall, and organizer shelf insert corresponds with a specific height of vertical storage in WaveWorks and Epic. See notation above models to see what model corresponds with appropriate height requirement
- Conference and training rooms commonly use 49" H inserts, but with Exhibit, you can use any of the 5 heights to achieve the customers needs
- As of April 20th, 2015, the inserts (Slat, Slat/Tack Combo, Insert Shelves, and TV Mount Inserts) will only be compatible with rails ordered on or after April 20th, 2015. If trying to use 1 of these inserts with an existing rail, please contact customer service for more information

## TO ORDER, SPECIFY:

1. Model Number
2. Paint Color

## SAMPLE MODEL NUMBER:

- 11N2449SW 462
- See pages 306-307 for all options available in Exhibit

MODEL NO./DESCRIPTION	LIST PRICE	DIMENSIONS					CARTONED WEIGHT	CUBIC FEET
		D	W	H	A	KW		
<b>SLAT WALL INSERTS (CONTINUED)</b>								
<b>COMPATIBLE WITH WAVEWORKS 80" HIGH WVN MODELS</b>								
<b>49"H FULL SLAT</b>								
11N2449SW	\$ 1397	½	24	48 <sup>13</sup> / <sub>16</sub>	—	—	63 lbs.	1.6
11N3049SW	1405	½	30	48 <sup>13</sup> / <sub>16</sub>	—	—	80 lbs.	1.9
11N3649SW	1605	½	36	48 <sup>13</sup> / <sub>16</sub>	—	—	97 lbs.	2.0
11N4249SW	1607	½	42	48 <sup>13</sup> / <sub>16</sub>	—	—	111 lbs.	2.2
11N4849SW	1785	½	48	48 <sup>13</sup> / <sub>16</sub>	—	—	128 lbs.	2.5

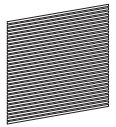

- 2 trim channels included with each slat wall insert in corresponding color to match slat
- Slat wall insert requires the use of trim channels and mounting bracket included with the model
- Slat wall should only be used with National certified work tools and monitor arms; reference pages 355-358

**PRODUCT SPECIFICATIONS**

- Each height of tack board, marker board, slat wall, and organizer shelf insert corresponds with a specific height of vertical storage in WaveWorks and Epic. See notation above models to see what model corresponds with appropriate height requirement
- Conference and training rooms commonly use 49" H inserts, but with Exhibit, you can use any of the 5 heights to achieve the customers needs
- As of April 20th, 2015, the inserts (Slat, Slat/Tack Combo, Insert Shelves, and TV Mount Inserts) will only be compatible with rails ordered on or after April 20th, 2015. If trying to use 1 of these inserts with an existing rail, please contact customer service for more information

**TO ORDER, SPECIFY:**

1. Model Number
2. Fabric Grade
3. Fabric Color
4. Paint Color

**SAMPLE MODEL NUMBER:**

11N2434SWTBFA A 8600 501

- See pages 306-307 for all options available in Exhibit

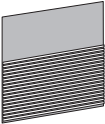
	MODEL NO./DESCRIPTION			LIST PRICE	GRADE B/COM	DIMENSIONS					CARTONED WEIGHT	CUBIC FEET
						D	W	H	A	KW		
<b>SLAT WALL INSERTS COMBO SLAT/TACK</b> 	<b>23"H SLAT WITH 11"H TACK</b>		<b>GRADE A</b>									
	<b>FABRIC TRIM</b>	<b>PAINTED TRIM</b>										
	11N2434SWTBFA	11N2434SWTBPA	Railroad	\$ 1058	\$ 1083	½	24	34½	—	—	32 lbs.	1.2
	11N3034SWTBFA	11N3034SWTBPA	Railroad	\$ 1061	\$ 1091	½	30	34½	—	—	41 lbs.	1.4
	11N3634SWTBFA	11N3634SWTBPA	Railroad	\$ 1211	\$ 1247	½	36	34½	—	—	50 lbs.	1.7
	11N4234SWTBFA	11N4234SWTBPA	Railroad	\$ 1212	\$ 1253	½	42	34½	—	—	59 lbs.	2.0
	11N4834SWTBFA	11N4834SWTBPA	Railroad	\$ 1348	\$ 1395	½	48	34½	—	—	68 lbs.	2.3
<b>COMPATIBLE WITH WAVEWORKS 68" HIGH WW AND EPIC 68" HIGH MODELS</b>												
	<b>23"H SLAT WITH 13"H TACK</b>		<b>GRADE A</b>									
	<b>FABRIC TRIM</b>	<b>PAINTED TRIM</b>										
	11N2436SWTBFA	11N2436SWTBPA	Railroad	\$ 1074	\$ 1099	½	24	36½	—	—	35 lbs.	1.2
	11N3036SWTBFA	11N3036SWTBPA	Railroad	\$ 1080	\$ 1110	½	30	36½	—	—	44 lbs.	1.4
	11N3636SWTBFA	11N3636SWTBPA	Railroad	\$ 1229	\$ 1265	½	36	36½	—	—	53 lbs.	1.7
	11N4236SWTBFA	11N4236SWTBPA	Railroad	\$ 1232	\$ 1273	½	42	36½	—	—	62 lbs.	2.0
	11N4836SWTBFA	11N4836SWTBPA	Railroad	\$ 1367	\$ 1414	½	48	36½	—	—	71 lbs.	2.3
<b>COMPATIBLE WITH WAVEWORKS 69" HIGH WWN MODELS</b>												
	<b>23"H SLAT WITH 14"H TACK</b>		<b>GRADE A</b>									
	<b>FABRIC TRIM</b>	<b>PAINTED TRIM</b>										
	11N2437SWTBFA	11N2437SWTBPA	Railroad	\$ 1074	\$ 1099	½	24	37	—	—	35 lbs.	1.2
	11N3037SWTBFA	11N3037SWTBPA	Railroad	\$ 1080	\$ 1110	½	30	37	—	—	44 lbs.	1.4
	11N3637SWTBFA	11N3637SWTBPA	Railroad	\$ 1229	\$ 1265	½	36	37	—	—	53 lbs.	1.7
	11N4237SWTBFA	11N4237SWTBPA	Railroad	\$ 1232	\$ 1273	½	42	37	—	—	62 lbs.	2.0
	11N4837SWTBFA	11N4837SWTBPA	Railroad	\$ 1367	\$ 1414	½	48	37	—	—	71 lbs.	2.3
<b>COMPATIBLE WITH WAVEWORKS 79" HIGH WW MODELS</b>												
	<b>23"H SLAT WITH 25"H TACK</b>		<b>GRADE A</b>									
	<b>FABRIC TRIM</b>	<b>PAINTED TRIM</b>										
	11N2448SWTBFA	11N2448SWTBPA	Railroad	\$ 1267	\$ 1292	½	24	48½	—	—	45 lbs.	1.4
	11N3048SWTBFA	11N3048SWTBPA	Railroad	\$ 1272	\$ 1302	½	30	48½	—	—	58 lbs.	1.7
	11N3648SWTBFA	11N3648SWTBPA	Railroad	\$ 1450	\$ 1486	½	36	48½	—	—	71 lbs.	2.1
	11N4248SWTBFA	11N4248SWTBPA	Railroad	\$ 1452	\$ 1493	½	42	48½	—	—	83 lbs.	2.5
	11N4848SWTBFA	11N4848SWTBPA	Railroad	\$ 1613	\$ 1660	½	48	48½	—	—	96 lbs.	2.9

- 2 trim channels included with each combo slat wall insert, customer can choose either fabric or painted trim channels
- Slat wall insert requires the use of trim channels and mounting bracket included with the model
- Slat wall should only be used with National certified work tools and monitor arms; reference pages 355-358
- Slat section must be located on the lower portion of the insert
- Fabric will be railroaded
- Not recommended to use more than 2 monitor arms per combo slat/tack model

# EXHIBIT

## PRODUCT SPECIFICATIONS

- Each height of tack board, marker board, slat wall, and organizer shelf insert corresponds with a specific height of vertical storage in WaveWorks and Epic. See notation above models to see what model corresponds with appropriate height requirement
- Conference and training rooms commonly use 49" H inserts, but with Exhibit, you can use any of the 5 heights to achieve the customers needs
- As of April 20th, 2015, the inserts (Slat, Slat/Tack Combo, Insert Shelves, and TV Mount Inserts) will only be compatible with rails ordered on or after April 20th, 2015. If trying to use 1 of these inserts with an existing rail, please contact customer service for more information

## TO ORDER, SPECIFY:

1. Model Number
2. Fabric Grade
3. Fabric Color
4. Paint Color

## SAMPLE MODEL NUMBER:

11N2449SWTBF A 8600 501

- See pages 306-307 for all options available in Exhibit

MODEL NO./DESCRIPTION	LIST PRICE	DIMENSIONS					CARTONED WEIGHT	CUBIC FEET			
		D	W	H	A	KW					
<b>SLAT WALL INSERTS</b>											
<b>COMBO SLAT/TACK (CONTINUED)</b>											
<b>COMPATIBLE WITH WAVEWORKS 80" HIGH WVN MODELS</b>											
<b>23"H SLAT WITH 26"H TACK</b>											
<b>FABRIC TRIM</b>			<b>GRADE A</b>		<b>GRADE B/COM</b>						
<b>PAINTED TRIM</b>											
11N2449SWTBFA	11N2449SWTBPA	Railroad	\$ 1267	\$ 1292	½	24	48 <sup>3</sup> / <sub>16</sub>	—	—	45 lbs.	1.4
11N3049SWTBFA	11N3049SWTBPA	Railroad	\$ 1272	\$ 1302	½	30	48 <sup>3</sup> / <sub>16</sub>	—	—	58 lbs.	1.7
11N3649SWTBFA	11N3649SWTBPA	Railroad	\$ 1450	\$ 1486	½	36	48 <sup>3</sup> / <sub>16</sub>	—	—	71 lbs.	2.1
11N4249SWTBFA	11N4249SWTBPA	Railroad	\$ 1452	\$ 1493	½	42	48 <sup>3</sup> / <sub>16</sub>	—	—	83 lbs.	2.5
11N4849SWTBFA	11N4849SWTBPA	Railroad	\$ 1613	\$ 1660	½	48	48 <sup>3</sup> / <sub>16</sub>	—	—	96 lbs.	2.9

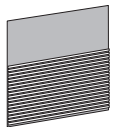

- 2 trim channels included with each combo slat wall insert, customer can choose either fabric or painted trim channels
- Slat wall insert requires the use of trim channels and mounting bracket included with the model
- Slat wall should only be used with National certified work tools and monitor arms; reference pages 355-358
- Slat section must be located on the lower portion of the insert
- Fabric will be railroaded
- Not recommended to use more than 2 monitor arms per combo slat/tack model



**PRODUCT SPECIFICATIONS**

- Each height of tack board, marker board, slat wall, and organizer shelf insert corresponds with a specific height of vertical storage in WaveWorks and Epic. See notation above models to see what model corresponds with appropriate height requirement
- Conference and training rooms commonly use 49" H inserts, but with Exhibit, you can use any of the 5 heights to achieve the customers needs
- As of April 20th, 2015, the inserts (Slat, Slat/Tack Combo, Insert Shelves, and TV Mount Inserts) will only be compatible with rails ordered on or after April 20th, 2015. If trying to use 1 of these inserts with an existing rail, please contact customer service for more information

**TO ORDER WOOD UNITS, SPECIFY:**

1. Model Number
2. Finish

**TO ORDER LW UNITS, SPECIFY:**

1. Model Number
2. Laminate Shelf Color
3. Finish Wall Color

**TO ORDER LAMINATE UNITS, SPECIFY:**

1. Model Number
2. Laminate Shelf Color
3. Laminate Wall Color

**TO ORDER WL UNITS, SPECIFY:**

1. Model Number
2. Wood Shelf Finish
3. Laminate Wall Color

**SAMPLE MODEL NUMBERS:**

11N3634SH1W MH  
 11N3634SH1LW 462 CW  
 11N3634SH1L 405 478

- See pages 306-307 for all options available in Exhibit

MODEL NO./DESCRIPTION	LIST PRICE	DIMENSIONS					CARTONED WEIGHT	CUBIC FEET
		D	W	H	A	KW		
<b>ORGANIZER SHELF INSERTS</b>								
<b>34"H ORGANIZER SHELF INSERTS</b>								
11N3634SH1W	Wood	\$ 1944	10½	35⅝	34⅞	—	—	47 lbs. 3.1
11N3634SH1LW	Laminate Shelves, Wood Wall	1944	10½	35⅝	34⅞	—	—	47 lbs. 3.1
11N3634SH1L	Laminate	1343	10½	35⅝	34⅞	—	—	47 lbs. 3.1
11N3634SH1WL	Wood Shelves, Laminate Wall	1944	10½	35⅝	34⅞	—	—	47 lbs. 3.1
<hr/>								
11N4234SH1W	Wood	\$ 1945	10½	41⅞	34⅞	—	—	53 lbs. 3.3
11N4234SH1LW	Laminate Shelves, Wood Wall	1945	10½	41⅞	34⅞	—	—	53 lbs. 3.3
11N4234SH1L	Laminate	1344	10½	41⅞	34⅞	—	—	53 lbs. 3.3
11N4234SH1WL	Wood Shelves, Laminate Wall	1945	10½	41⅞	34⅞	—	—	53 lbs. 3.3
<hr/>								
11N4834SH1W	Wood	\$ 2162	10½	47⅞	34⅞	—	—	58 lbs. 3.5
11N4834SH1LW	Laminate Shelves, Wood Wall	2162	10½	47⅞	34⅞	—	—	58 lbs. 3.5
11N4834SH1L	Laminate	1490	10½	47⅞	34⅞	—	—	58 lbs. 3.5
11N4834SH1WL	Wood Shelves, Laminate Wall	2162	10½	47⅞	34⅞	—	—	58 lbs. 3.5
<hr/>								
11N5434SH1W	Wood	\$ 2380	10½	53⅞	34⅞	—	—	64 lbs. 3.5
11N5434SH1LW	Laminate Shelves, Wood Wall	2380	10½	53⅞	34⅞	—	—	64 lbs. 3.5
11N5434SH1L	Laminate	1640	10½	53⅞	34⅞	—	—	64 lbs. 3.5
11N5434SH1WL	Wood Shelves, Laminate Wall	2380	10½	53⅞	34⅞	—	—	64 lbs. 3.5
<hr/>								
11N6034SH1W	Wood	\$ 2618	10½	59⅞	34⅞	—	—	71 lbs. 3.9
11N6034SH1LW	Laminate Shelves, Wood Wall	2618	10½	59⅞	34⅞	—	—	71 lbs. 3.9
11N6034SH1L	Laminate	1805	10½	59⅞	34⅞	—	—	71 lbs. 3.9
11N6034SH1WL	Wood Shelves, Laminate Wall	2618	10½	59⅞	34⅞	—	—	71 lbs. 3.9

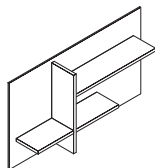
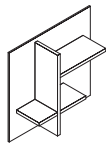

- Some assembly required
- 34", 36" and 37" high shelf inserts have 3 shelves
- The grain direction of all woodgrains will be horizontal (left to right) on the horizontal shelves
- Almond Horizontal (ADH), Portobello Horizontal (PBH), Portico Horizontal (PTH), Skyline Horizontal (SKH), Sonoma Horizontal (SMH), Designer White Linear Horizontal (491H), Cinder Linear Horizontal (492H) and Sable Horizontal (792H) laminates have horizontal grain on the wall insert and vertical shelves. All other woodgrains have vertical grain on the wall insert and vertical shelves
- Each horizontal shelf has a 50 lb. maximum limit

# EXHIBIT

## PRODUCT SPECIFICATIONS

- Each height of tack board, marker board, slat wall, and organizer shelf insert corresponds with a specific height of vertical storage in WaveWorks and Epic. See notation above models to see what model corresponds with appropriate height requirement
- Conference and training rooms commonly use 49" H inserts, but with Exhibit, you can use any of the 5 heights to achieve the customers needs
- As of April 20th, 2015, the inserts (Slat, Slat/Tack Combo, Insert Shelves, and TV Mount Inserts) will only be compatible with rails ordered on or after April 20th, 2015. If trying to use 1 of these inserts with an existing rail, please contact customer service for more information

## TO ORDER WOOD UNITS, SPECIFY:

1. Model Number
2. Finish

## TO ORDER LW UNITS, SPECIFY:

1. Model Number
2. Laminate Shelf Color
3. Finish Wall Color

## TO ORDER LAMINATE UNITS, SPECIFY:

1. Model Number
2. Laminate Shelf Color
3. Laminate Wall Color

## TO ORDER WL UNITS, SPECIFY:

1. Model Number
2. Wood Shelf Finish
3. Laminate Wall Color

## SAMPLE MODEL NUMBERS:

11N3634SH2W MH  
 11N3634SH2LW 462 CW  
 11N3634SH2L 405 478

- See pages 306-307 for all options available in Exhibit

MODEL NO./DESCRIPTION	LIST PRICE	DIMENSIONS					CARTONED WEIGHT	CUBIC FEET
		D	W	H	A	KW		
<b>ORGANIZER SHELF INSERTS (CONTINUED)</b>								
<b>34"H ORGANIZER SHELF INSERTS (CONTINUED)</b>								
11N3634SH2W Wood	\$ 1944	10½	35⅝	34¾	—	—	47 lbs.	3.1
11N3634SH2LW Laminate Shelves, Wood Wall	1944	10½	35⅝	34¾	—	—	47 lbs.	3.1
11N3634SH2L Laminate	1343	10½	35⅝	34¾	—	—	47 lbs.	3.1
11N3634SH2WL Wood Shelves, Laminate Wall	1944	10½	35⅝	34¾	—	—	47 lbs.	3.1
<hr/>								
11N4234SH2W Wood	\$ 1945	10½	41⅞	34¾	—	—	53 lbs.	3.3
11N4234SH2LW Laminate Shelves, Wood Wall	1945	10½	41⅞	34¾	—	—	53 lbs.	3.3
11N4234SH2L Laminate	1344	10½	41⅞	34¾	—	—	53 lbs.	3.3
11N4234SH2WL Wood Shelves, Laminate Wall	1945	10½	41⅞	34¾	—	—	53 lbs.	3.3
<hr/>								
11N4834SH2W Wood	\$ 2162	10½	47⅞	34¾	—	—	58 lbs.	3.5
11N4834SH2LW Laminate Shelves, Wood Wall	2162	10½	47⅞	34¾	—	—	58 lbs.	3.5
11N4834SH2L Laminate	1490	10½	47⅞	34¾	—	—	58 lbs.	3.5
11N4834SH2WL Wood Shelves, Laminate Wall	2162	10½	47⅞	34¾	—	—	58 lbs.	3.5
<hr/>								
11N5434SH2W Wood	\$ 2380	10½	53%	34¾	—	—	64 lbs.	3.5
11N5434SH2LW Laminate Shelves, Wood Wall	2380	10½	53%	34¾	—	—	64 lbs.	3.5
11N5434SH2L Laminate	1640	10½	53%	34¾	—	—	64 lbs.	3.5
11N5434SH2WL Wood Shelves, Laminate Wall	2380	10½	53%	34¾	—	—	64 lbs.	3.5
<hr/>								
11N6034SH2W Wood	\$ 2618	10½	59⅞	34¾	—	—	71 lbs.	3.9
11N6034SH2LW Laminate Shelves, Wood Wall	2618	10½	59⅞	34¾	—	—	71 lbs.	3.9
11N6034SH2L Laminate	1805	10½	59⅞	34¾	—	—	71 lbs.	3.9
11N6034SH2WL Wood Shelves, Laminate Wall	2618	10½	59⅞	34¾	—	—	71 lbs.	3.9

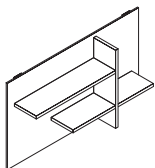
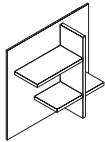

- Some assembly required
- 34", 36" and 37" high shelf inserts have 3 shelves
- "SH2" shelves are a mirrored version of the "SH1" shelves
- The grain direction of all woodgrains will be horizontal (left to right) on the horizontal shelves
- Almond Horizontal (ADH), Portobello Horizontal (PBH), Portico Horizontal (PTH), Skyline Horizontal (SKH), Sonoma Horizontal (SMH), Designer White Linear Horizontal (491H), Cinder Linear Horizontal (492H) and Sable Horizontal (792H) laminates have horizontal grain on the wall insert and vertical shelves. All other woodgrains have vertical grain on the wall insert and vertical shelves
- Each horizontal shelf has a 50 lb. maximum limit

**PRODUCT SPECIFICATIONS**

- Each height of tack board, marker board, slat wall, and organizer shelf insert corresponds with a specific height of vertical storage in WaveWorks and Epic. See notation above models to see what model corresponds with appropriate height requirement
- Conference and training rooms commonly use 49" H inserts, but with Exhibit, you can use any of the 5 heights to achieve the customers needs
- As of April 20th, 2015, the inserts (Slat, Slat/Tack Combo, Insert Shelves, and TV Mount Inserts) will only be compatible with rails ordered on or after April 20th, 2015. If trying to use 1 of these inserts with an existing rail, please contact customer service for more information

**TO ORDER WOOD UNITS, SPECIFY:**

1. Model Number
2. Finish

**TO ORDER LW UNITS, SPECIFY:**

1. Model Number
2. Laminate Shelf Color
3. Finish Wall Color

**TO ORDER LAMINATE UNITS, SPECIFY:**

1. Model Number
2. Laminate Shelf Color
3. Laminate Wall Color

**TO ORDER WL UNITS, SPECIFY:**

1. Model Number
2. Wood Shelf Finish
3. Laminate Wall Color

**SAMPLE MODEL NUMBERS:**

11N3634SH3W MH  
 11N3634SH3LW 462 CW  
 11N3634SH3L 405 478

- See pages 306-307 for all options available in Exhibit

MODEL NO./DESCRIPTION	LIST PRICE	DIMENSIONS					CARTONED WEIGHT	CUBIC FEET
		D	W	H	A	KW		
<b>ORGANIZER SHELF INSERTS (CONTINUED)</b>								
<b>34"H ORGANIZER SHELF INSERTS (CONTINUED)</b>								
11N3634SH3W Wood	\$ 1654	10½	35⅞	34⅞	—	—	41 lbs.	3.3
11N3634SH3LW Laminate Shelves, Wood Wall	1654	10½	35⅞	34⅞	—	—	41 lbs.	3.3
11N3634SH3L Laminate	1141	10½	35⅞	34⅞	—	—	41 lbs.	3.3
11N3634SH3WL Wood Shelves, Laminate Wall	1654	10½	35⅞	34⅞	—	—	41 lbs.	3.3
<hr/>								
11N4234SH3W Wood	\$ 1655	10½	41⅞	34⅞	—	—	48 lbs.	3.8
11N4234SH3LW Laminate Shelves, Wood Wall	1655	10½	41⅞	34⅞	—	—	48 lbs.	3.8
11N4234SH3L Laminate	1142	10½	41⅞	34⅞	—	—	48 lbs.	3.8
11N4234SH3WL Wood Shelves, Laminate Wall	1655	10½	41⅞	34⅞	—	—	48 lbs.	3.8
<hr/>								
11N4834SH3W Wood	\$ 1838	10½	47⅞	34⅞	—	—	54 lbs.	4.3
11N4834SH3LW Laminate Shelves, Wood Wall	1838	10½	47⅞	34⅞	—	—	54 lbs.	4.3
11N4834SH3L Laminate	1268	10½	47⅞	34⅞	—	—	54 lbs.	4.3
11N4834SH3WL Wood Shelves, Laminate Wall	1838	10½	47⅞	34⅞	—	—	54 lbs.	4.3
<hr/>								
11N5434SH3W Wood	\$ 2022	10½	53⅞	34⅞	—	—	59 lbs.	4.8
11N5434SH3LW Laminate Shelves, Wood Wall	2022	10½	53⅞	34⅞	—	—	59 lbs.	4.8
11N5434SH3L Laminate	1396	10½	53⅞	34⅞	—	—	59 lbs.	4.8
11N5434SH3WL Wood Shelves, Laminate Wall	2022	10½	53⅞	34⅞	—	—	59 lbs.	4.8
<hr/>								
11N6034SH3W Wood	\$ 2225	10½	59⅞	34⅞	—	—	66 lbs.	5.3
11N6034SH3LW Laminate Shelves, Wood Wall	2225	10½	59⅞	34⅞	—	—	66 lbs.	5.3
11N6034SH3L Laminate	1536	10½	59⅞	34⅞	—	—	66 lbs.	5.3
11N6034SH3WL Wood Shelves, Laminate Wall	2225	10½	59⅞	34⅞	—	—	66 lbs.	5.3

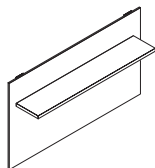
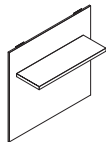

- Some assembly required
- "SH3" models have 1 shelf that aligns with the top shelf of the "SH1" and "SH2" shelves
- The grain direction of all woodgrains will be horizontal (left to right) on the horizontal shelves
- Almond Horizontal (ADH), Portobello Horizontal (PBH), Portico Horizontal (PTH), Skyline Horizontal (SKH), Sonoma Horizontal (SMH), Designer White Linear Horizontal (491H), Cinder Linear Horizontal (492H) and Sable Horizontal (792H) laminates have horizontal grain on the wall insert and vertical shelves. All other woodgrains have vertical grain on the wall insert and vertical shelves
- Each horizontal shelf has a 50 lb. maximum limit

# EXHIBIT

## PRODUCT SPECIFICATIONS

- Each height of tack board, marker board, slat wall, and organizer shelf insert corresponds with a specific height of vertical storage in WaveWorks and Epic. See notation above models to see what model corresponds with appropriate height requirement
- Conference and training rooms commonly use 49" H inserts, but with Exhibit, you can use any of the 5 heights to achieve the customers needs
- As of April 20th, 2015, the inserts (Slat, Slat/Tack Combo, Insert Shelves, and TV Mount Inserts) will only be compatible with rails ordered on or after April 20th, 2015. If trying to use 1 of these inserts with an existing rail, please contact customer service for more information

## TO ORDER WOOD UNITS, SPECIFY:

1. Model Number
2. Finish

## TO ORDER LW UNITS, SPECIFY:

1. Model Number
2. Laminate Shelf Color
3. Finish Wall Color

## TO ORDER LAMINATE UNITS, SPECIFY:

1. Model Number
2. Laminate Shelf Color
3. Laminate Wall Color

## TO ORDER WL UNITS, SPECIFY:

1. Model Number
2. Wood Shelf Finish
3. Laminate Wall Color

## SAMPLE MODEL NUMBERS:

11N3634SH4W MH  
 11N3634SH4W 462 CW  
 11N3634SH4L 405 478

- See pages 306-307 for all options available in Exhibit

MODEL NO./DESCRIPTION	LIST PRICE	DIMENSIONS					CARTONED WEIGHT	CUBIC FEET
		D	W	H	A	KW		
<b>ORGANIZER SHELF INSERTS (CONTINUED)</b>								
<b>34"H ORGANIZER SHELF INSERTS (CONTINUED)</b>								
11N3634SH4W Wood	\$ 1692	10½	35⅝	34½	—	—	49 lbs.	3.3
11N3634SH4LW Laminate Shelves, Wood Wall	1692	10½	35⅝	34½	—	—	49 lbs.	3.3
11N3634SH4L Laminate	1166	10½	35⅝	34½	—	—	49 lbs.	3.3
11N3634SH4WL Wood Shelves, Laminate Wall	1692	10½	35⅝	34½	—	—	49 lbs.	3.3
<hr/>								
11N4234SH4W Wood	\$ 1693	10½	41⅞	34½	—	—	57 lbs.	3.8
11N4234SH4LW Laminate Shelves, Wood Wall	1693	10½	41⅞	34½	—	—	57 lbs.	3.8
11N4234SH4L Laminate	1168	10½	41⅞	34½	—	—	57 lbs.	3.8
11N4234SH4WL Wood Shelves, Laminate Wall	1693	10½	41⅞	34½	—	—	57 lbs.	3.8
<hr/>								
11N4834SH4W Wood	\$ 1881	10½	47⅞	34½	—	—	65 lbs.	4.3
11N4834SH4LW Laminate Shelves, Wood Wall	1881	10½	47⅞	34½	—	—	65 lbs.	4.3
11N4834SH4L Laminate	1298	10½	47⅞	34½	—	—	65 lbs.	4.3
11N4834SH4WL Wood Shelves, Laminate Wall	1881	10½	47⅞	34½	—	—	65 lbs.	4.3
<hr/>								
11N5434SH4W Wood	\$ 2071	10½	53%	34½	—	—	73 lbs.	4.8
11N5434SH4LW Laminate Shelves, Wood Wall	2071	10½	53%	34½	—	—	73 lbs.	4.8
11N5434SH4L Laminate	1428	10½	53%	34½	—	—	73 lbs.	4.8
11N5434SH4WL Wood Shelves, Laminate Wall	2071	10½	53%	34½	—	—	73 lbs.	4.8
<hr/>								
11N6034SH4W Wood	\$ 2277	10½	59⅞	34½	—	—	81 lbs.	5.3
11N6034SH4LW Laminate Shelves, Wood Wall	2277	10½	59⅞	34½	—	—	81 lbs.	5.3
11N6034SH4L Laminate	1570	10½	59⅞	34½	—	—	81 lbs.	5.3
11N6034SH4WL Wood Shelves, Laminate Wall	2277	10½	59⅞	34½	—	—	81 lbs.	5.3

- Some assembly required
- "SH4" models have 2 shelves that align with the horizontal shelves of the "SH1" and "SH2" shelves
- The grain direction of all woodgrains will be horizontal (left to right) on the horizontal shelves
- Almond Horizontal (ADH), Portobello Horizontal (PBH), Portico Horizontal (PTH), Skyline Horizontal (SKH), Sonoma Horizontal (SMH), Designer White Linear Horizontal (491H), Cinder Linear Horizontal (492H) and Sable Horizontal (792H) laminates have horizontal grain on the wall insert and vertical shelves. All other woodgrains have vertical grain on the wall insert and vertical shelves
- Each horizontal shelf has a 50 lb. maximum limit

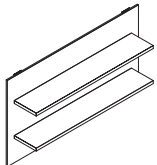
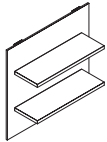

**PRODUCT SPECIFICATIONS**

- Each height of tack board, marker board, slat wall, and organizer shelf insert corresponds with a specific height of vertical storage in WaveWorks and Epic. See notation above models to see what model corresponds with appropriate height requirement
- Conference and training rooms commonly use 49" H inserts, but with Exhibit, you can use any of the 5 heights to achieve the customers needs
- As of April 20th, 2015, the inserts (Slat, Slat/Tack Combo, Insert Shelves, and TV Mount Inserts) will only be compatible with rails ordered on or after April 20th, 2015. If trying to use 1 of these inserts with an existing rail, please contact customer service for more information

**TO ORDER WOOD UNITS, SPECIFY:**

1. Model Number
2. Finish

**TO ORDER LW UNITS, SPECIFY:**

1. Model Number
2. Laminate Shelf Color
3. Finish Wall Color

**TO ORDER LAMINATE UNITS, SPECIFY:**

1. Model Number
2. Laminate Shelf Color
3. Laminate Wall Color

**TO ORDER WL UNITS, SPECIFY:**

1. Model Number
2. Wood Shelf Finish
3. Laminate Wall Color

**SAMPLE MODEL NUMBERS:**

11N3634SH6W MH  
 11N3634SH6LW 462 CW  
 11N3634SH6L 405 478

- See pages 306-307 for all options available in Exhibit

MODEL NO./DESCRIPTION	LIST PRICE	DIMENSIONS					CARTONED WEIGHT	CUBIC FEET
		D	W	H	A	KW		
<b>ORGANIZER SHELF INSERTS (CONTINUED)</b>								
<b>34" H ORGANIZER SHELF INSERTS (CONTINUED)</b>								
11N3634SH6W Wood	\$ 1654	10½	35⅝	34⅞	—	—	41 lbs.	3.3
11N3634SH6LW Laminate Shelves, Wood Wall	1654	10½	35⅝	34⅞	—	—	41 lbs.	3.3
11N3634SH6L Laminate	1141	10½	35⅝	34⅞	—	—	41 lbs.	3.3
11N3634SH6WL Wood Shelves, Laminate Wall	1654	10½	35⅝	34⅞	—	—	41 lbs.	3.3
<hr/>								
11N4234SH6W Wood	\$ 1655	10½	41⅞	34⅞	—	—	48 lbs.	3.8
11N4234SH6LW Laminate Shelves, Wood Wall	1655	10½	41⅞	34⅞	—	—	48 lbs.	3.8
11N4234SH6L Laminate	1142	10½	41⅞	34⅞	—	—	48 lbs.	3.8
11N4234SH6WL Wood Shelves, Laminate Wall	1655	10½	41⅞	34⅞	—	—	48 lbs.	3.8
<hr/>								
11N4834SH6W Wood	\$ 1838	10½	47⅞	34⅞	—	—	54 lbs.	4.3
11N4834SH6LW Laminate Shelves, Wood Wall	1838	10½	47⅞	34⅞	—	—	54 lbs.	4.3
11N4834SH6L Laminate	1268	10½	47⅞	34⅞	—	—	54 lbs.	4.3
11N4834SH6WL Wood Shelves, Laminate Wall	1838	10½	47⅞	34⅞	—	—	54 lbs.	4.3
<hr/>								
11N5434SH6W Wood	\$ 2022	10½	53⅞	34⅞	—	—	59 lbs.	4.8
11N5434SH6LW Laminate Shelves, Wood Wall	2022	10½	53⅞	34⅞	—	—	59 lbs.	4.8
11N5434SH6L Laminate	1396	10½	53⅞	34⅞	—	—	59 lbs.	4.8
11N5434SH6WL Wood Shelves, Laminate Wall	2022	10½	53⅞	34⅞	—	—	59 lbs.	4.8
<hr/>								
11N6034SH6W Wood	\$ 2225	10½	59⅞	34⅞	—	—	66 lbs.	5.3
11N6034SH6LW Laminate Shelves, Wood Wall	2225	10½	59⅞	34⅞	—	—	66 lbs.	5.3
11N6034SH6L Laminate	1536	10½	59⅞	34⅞	—	—	66 lbs.	5.3
11N6034SH6WL Wood Shelves, Laminate Wall	2225	10½	59⅞	34⅞	—	—	66 lbs.	5.3

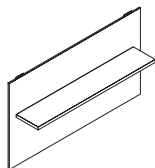
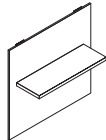

- Some assembly required
- "SH6" 34" high models have 1 shelf that aligns with the bottom of a metal overhead
- The grain direction of all woodgrains will be horizontal (left to right) on the horizontal shelves
- Almond Horizontal (ADH), Portobello Horizontal (PBH), Portico Horizontal (PTH), Skyline Horizontal (SKH), Sonoma Horizontal (SMH), Designer White Linear Horizontal (491H), Cinder Linear Horizontal (492H) and Sable Horizontal (792H) laminates have horizontal grain on the wall insert and vertical shelves. All other woodgrains have vertical grain on the wall insert and vertical shelves
- Each horizontal shelf has a 50 lb. maximum limit

# EXHIBIT

## PRODUCT SPECIFICATIONS

- Each height of tack board, marker board, slat wall, and organizer shelf insert corresponds with a specific height of vertical storage in WaveWorks and Epic. See notation above models to see what model corresponds with appropriate height requirement
- Conference and training rooms commonly use 49" H inserts, but with Exhibit, you can use any of the 5 heights to achieve the customers needs
- As of April 20th, 2015, the inserts (Slat, Slat/Tack Combo, Insert Shelves, and TV Mount Inserts) will only be compatible with rails ordered on or after April 20th, 2015. If trying to use 1 of these inserts with an existing rail, please contact customer service for more information

## TO ORDER WOOD UNITS, SPECIFY:

1. Model Number
2. Finish

## TO ORDER LW UNITS, SPECIFY:

1. Model Number
2. Laminate Shelf Color
3. Finish Wall Color

## TO ORDER LAMINATE UNITS, SPECIFY:

1. Model Number
2. Laminate Shelf Color
3. Laminate Wall Color

## TO ORDER WL UNITS, SPECIFY:

1. Model Number
2. Wood Shelf Finish
3. Laminate Wall Color

## SAMPLE MODEL NUMBERS:

11N3636SH1W MH  
 11N3636SH1LW 462 CW  
 11N3636SH1L 405 478

- See pages 306-307 for all options available in Exhibit

MODEL NO./DESCRIPTION	LIST PRICE	DIMENSIONS					CARTONED WEIGHT	CUBIC FEET
		D	W	H	A	KW		
<b>COMPATIBLE WITH WAVEWORKS 68" HIGH WW AND EPIC 68" HIGH MODELS</b>								
<b>36"H ORGANIZER SHELF INSERTS</b>								
11N3636SH1W Wood	\$ 1972	10½	35½	36½	—	—	51 lbs.	3.4
11N3636SH1LW Laminate Shelves, Wood Wall	1972	10½	35½	36½	—	—	51 lbs.	3.4
11N3636SH1L Laminate	1358	10½	35½	36½	—	—	51 lbs.	3.4
11N3636SH1WL Wood Shelves, Laminate Wall	1972	10½	35½	36½	—	—	51 lbs.	3.4
<hr/>								
11N4236SH1W Wood	\$ 1975	10½	41½	36½	—	—	57 lbs.	3.6
11N4236SH1LW Laminate Shelves, Wood Wall	1975	10½	41½	36½	—	—	57 lbs.	3.6
11N4236SH1L Laminate	1360	10½	41½	36½	—	—	57 lbs.	3.6
11N4236SH1WL Wood Shelves, Laminate Wall	1975	10½	41½	36½	—	—	57 lbs.	3.6
<hr/>								
11N4836SH1W Wood	\$ 2194	10½	47½	36½	—	—	62 lbs.	3.9
11N4836SH1LW Laminate Shelves, Wood Wall	2194	10½	47½	36½	—	—	62 lbs.	3.9
11N4836SH1L Laminate	1513	10½	47½	36½	—	—	62 lbs.	3.9
11N4836SH1WL Wood Shelves, Laminate Wall	2194	10½	47½	36½	—	—	62 lbs.	3.9
<hr/>								
11N5436SH1W Wood	\$ 2413	10½	53½	36½	—	—	68 lbs.	4.1
11N5436SH1LW Laminate Shelves, Wood Wall	2413	10½	53½	36½	—	—	68 lbs.	4.1
11N5436SH1L Laminate	1665	10½	53½	36½	—	—	68 lbs.	4.1
11N5436SH1WL Wood Shelves, Laminate Wall	2413	10½	53½	36½	—	—	68 lbs.	4.1
<hr/>								
11N6036SH1W Wood	\$ 2655	10½	59½	36½	—	—	74 lbs.	4.3
11N6036SH1LW Laminate Shelves, Wood Wall	2655	10½	59½	36½	—	—	74 lbs.	4.3
11N6036SH1L Laminate	1831	10½	59½	36½	—	—	74 lbs.	4.3
11N6036SH1WL Wood Shelves, Laminate Wall	2655	10½	59½	36½	—	—	74 lbs.	4.3

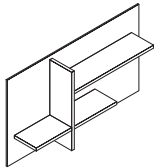
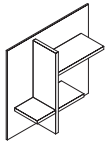

- Some assembly required
- 34", 36" and 37" high shelf inserts have 3 shelves
- The grain direction of all woodgrains will be horizontal (left to right) on the horizontal shelves
- Almond Horizontal (ADH), Portobello Horizontal (PBH), Portico Horizontal (PTH), Skyline Horizontal (SKH), Sonoma Horizontal (SMH), Designer White Linear Horizontal (491H), Cinder Linear Horizontal (492H) and Sable Horizontal (792H) laminates have horizontal grain on the wall insert and vertical shelves. All other woodgrains have vertical grain on the wall insert and vertical shelves
- Each horizontal shelf has a 50 lb. maximum limit

**PRODUCT SPECIFICATIONS**

- Each height of tack board, marker board, slat wall, and organizer shelf insert corresponds with a specific height of vertical storage in WaveWorks and Epic. See notation above models to see what model corresponds with appropriate height requirement
- Conference and training rooms commonly use 49" H inserts, but with Exhibit, you can use any of the 5 heights to achieve the customers needs
- As of April 20th, 2015, the inserts (Slat, Slat/Tack Combo, Insert Shelves, and TV Mount Inserts) will only be compatible with rails ordered on or after April 20th, 2015. If trying to use 1 of these inserts with an existing rail, please contact customer service for more information

**TO ORDER WOOD UNITS, SPECIFY:**

1. Model Number
2. Finish

**TO ORDER LW UNITS, SPECIFY:**

1. Model Number
2. Laminate Shelf Color
3. Finish Wall Color

**TO ORDER LAMINATE UNITS, SPECIFY:**

1. Model Number
2. Laminate Shelf Color
3. Laminate Wall Color

**TO ORDER WL UNITS, SPECIFY:**

1. Model Number
2. Wood Shelf Finish
3. Laminate Wall Color

**SAMPLE MODEL NUMBERS:**

11N3636SH2W MH  
 11N3636SH2LW 462 CW  
 11N3636SH2L 405 478

- See pages 306-307 for all options available in Exhibit

MODEL NO./DESCRIPTION	LIST PRICE	DIMENSIONS				KW	CARTONED WEIGHT	CUBIC FEET
		D	W	H	A			
<b>COMPATIBLE WITH WAVEWORKS 68" HIGH WW AND EPIC 68" HIGH MODELS 36"H ORGANIZER SHELF INSERTS (CONTINUED)</b>								
11N3636SH2W Wood	\$ 1972	10½	35½	36	—	—	51 lbs.	3.4
11N3636SH2LW Laminate Shelves, Wood Wall	1972	10½	35½	36	—	—	51 lbs.	3.4
11N3636SH2L Laminate	1358	10½	35½	36	—	—	51 lbs.	3.4
11N3636SH2WL Wood Shelves, Laminate Wall	1972	10½	35½	36	—	—	51 lbs.	3.4
<hr/>								
11N4236SH2W Wood	\$ 1975	10½	41½	36	—	—	57 lbs.	3.6
11N4236SH2LW Laminate Shelves, Wood Wall	1975	10½	41½	36	—	—	57 lbs.	3.6
11N4236SH2L Laminate	1360	10½	41½	36	—	—	57 lbs.	3.6
11N4236SH2WL Wood Shelves, Laminate Wall	1975	10½	41½	36	—	—	57 lbs.	3.6
<hr/>								
11N4836SH2W Wood	\$ 2194	10½	47½	36	—	—	62 lbs.	3.9
11N4836SH2LW Laminate Shelves, Wood Wall	2194	10½	47½	36	—	—	62 lbs.	3.9
11N4836SH2L Laminate	1513	10½	47½	36	—	—	62 lbs.	3.9
11N4836SH2WL Wood Shelves, Laminate Wall	2194	10½	47½	36	—	—	62 lbs.	3.9
<hr/>								
11N5436SH2W Wood	\$ 2413	10½	53	36	—	—	68 lbs.	4.1
11N5436SH2LW Laminate Shelves, Wood Wall	2413	10½	53	36	—	—	68 lbs.	4.1
11N5436SH2L Laminate	1665	10½	53	36	—	—	68 lbs.	4.1
11N5436SH2WL Wood Shelves, Laminate Wall	2413	10½	53	36	—	—	68 lbs.	4.1
<hr/>								
11N6036SH2W Wood	\$ 2655	10½	59½	36	—	—	74 lbs.	4.3
11N6036SH2LW Laminate Shelves, Wood Wall	2655	10½	59½	36	—	—	74 lbs.	4.3
11N6036SH2L Laminate	1831	10½	59½	36	—	—	74 lbs.	4.3
11N6036SH2WL Wood Shelves, Laminate Wall	2655	10½	59½	36	—	—	74 lbs.	4.3

**ORGANIZER SHELF INSERTS (CONTINUED)**

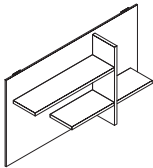
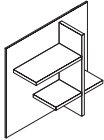

- Some assembly required
- "SH2" shelves are a mirrored version of the "SH1" shelves
- The grain direction of all woodgrains will be horizontal (left to right) on the horizontal shelves
- Almond Horizontal (ADH), Portobello Horizontal (PBH), Portico Horizontal (PTH), Skyline Horizontal (SKH), Sonoma Horizontal (SMH), Designer White Linear Horizontal (491H), Cinder Linear Horizontal (492H) and Sable Horizontal (792H) laminates have horizontal grain on the wall insert and vertical shelves. All other woodgrains have vertical grain on the wall insert and vertical shelves
- Each horizontal shelf has a 50 lb. maximum limit

# EXHIBIT

## PRODUCT SPECIFICATIONS

- Each height of tack board, marker board, slat wall, and organizer shelf insert corresponds with a specific height of vertical storage in WaveWorks and Epic. See notation above models to see what model corresponds with appropriate height requirement
- Conference and training rooms commonly use 49" H inserts, but with Exhibit, you can use any of the 5 heights to achieve the customers needs
- As of April 20th, 2015, the inserts (Slat, Slat/Tack Combo, Insert Shelves, and TV Mount Inserts) will only be compatible with rails ordered on or after April 20th, 2015. If trying to use 1 of these inserts with an existing rail, please contact customer service for more information

## TO ORDER WOOD UNITS, SPECIFY:

1. Model Number
2. Finish

## TO ORDER LW UNITS, SPECIFY:

1. Model Number
2. Laminate Shelf Color
3. Finish Wall Color

## TO ORDER LAMINATE UNITS, SPECIFY:

1. Model Number
2. Laminate Shelf Color
3. Laminate Wall Color

## TO ORDER WL UNITS, SPECIFY:

1. Model Number
2. Wood Shelf Finish
3. Laminate Wall Color

## SAMPLE MODEL NUMBERS:

11N3636SH3W MH  
 11N3636SH3LW 462 CW  
 11N3636SH3L 405 478

- See pages 306-307 for all options available in Exhibit

MODEL NO./DESCRIPTION	LIST PRICE	DIMENSIONS					CARTONED WEIGHT	CUBIC FEET
		D	W	H	A	KW		
<b>ORGANIZER SHELF INSERTS (CONTINUED)</b>								
<b>COMPATIBLE WITH WAVEWORKS 68" HIGH WW AND EPIC 68" HIGH MODELS</b>								
<b>36"H ORGANIZER SHELF INSERTS (CONTINUED)</b>								
11N3636SH3W Wood	\$ 1675	10½	35½	36½	—	—	43 lbs.	3.5
11N3636SH3LW Laminate Shelves, Wood Wall	1675	10½	35½	36½	—	—	43 lbs.	3.5
11N3636SH3L Laminate	1155	10½	35½	36½	—	—	43 lbs.	3.5
11N3636SH3WL Wood Shelves, Laminate Wall	1675	10½	35½	36½	—	—	43 lbs.	3.5
<hr/>								
11N4236SH3W Wood	\$ 1679	10½	41½	36½	—	—	49 lbs.	4.1
11N4236SH3LW Laminate Shelves, Wood Wall	1679	10½	41½	36½	—	—	49 lbs.	4.1
11N4236SH3L Laminate	1158	10½	41½	36½	—	—	49 lbs.	4.1
11N4236SH3WL Wood Shelves, Laminate Wall	1679	10½	41½	36½	—	—	49 lbs.	4.1
<hr/>								
11N4836SH3W Wood	\$ 1865	10½	47½	36½	—	—	56 lbs.	4.6
11N4836SH3LW Laminate Shelves, Wood Wall	1865	10½	47½	36½	—	—	56 lbs.	4.6
11N4836SH3L Laminate	1286	10½	47½	36½	—	—	56 lbs.	4.6
11N4836SH3WL Wood Shelves, Laminate Wall	1865	10½	47½	36½	—	—	56 lbs.	4.6
<hr/>								
11N5436SH3W Wood	\$ 2052	10½	53½	36½	—	—	63 lbs.	5.1
11N5436SH3LW Laminate Shelves, Wood Wall	2052	10½	53½	36½	—	—	63 lbs.	5.1
11N5436SH3L Laminate	1415	10½	53½	36½	—	—	63 lbs.	5.1
11N5436SH3WL Wood Shelves, Laminate Wall	2052	10½	53½	36½	—	—	63 lbs.	5.1
<hr/>								
11N6036SH3W Wood	\$ 2256	10½	59½	36½	—	—	69 lbs.	5.6
11N6036SH3LW Laminate Shelves, Wood Wall	2256	10½	59½	36½	—	—	69 lbs.	5.6
11N6036SH3L Laminate	1557	10½	59½	36½	—	—	69 lbs.	5.6
11N6036SH3WL Wood Shelves, Laminate Wall	2256	10½	59½	36½	—	—	69 lbs.	5.6

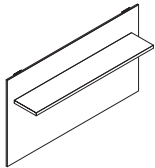
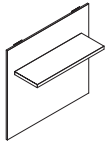

- Some assembly required
- "SH3" models have 1 shelf that aligns with the top shelf of the "SH1" and "SH2" shelves
- The grain direction of all woodgrains will be horizontal (left to right) on the horizontal shelves
- Almond Horizontal (ADH), Portobello Horizontal (PBH), Portico Horizontal (PTH), Skyline Horizontal (SKH), Sonoma Horizontal (SMH), Designer White Linear Horizontal (491H), Cinder Linear Horizontal (492H) and Sable Horizontal (792H) laminates have horizontal grain on the wall insert and vertical shelves. All other woodgrains have vertical grain on the wall insert and vertical shelves
- Each horizontal shelf has a 50 lb. maximum limit



**PRODUCT SPECIFICATIONS**

- Each height of tack board, marker board, slat wall, and organizer shelf insert corresponds with a specific height of vertical storage in WaveWorks and Epic. See notation above models to see what model corresponds with appropriate height requirement
- Conference and training rooms commonly use 49" H inserts, but with Exhibit, you can use any of the 5 heights to achieve the customers needs
- As of April 20th, 2015, the inserts (Slat, Slat/Tack Combo, Insert Shelves, and TV Mount Inserts) will only be compatible with rails ordered on or after April 20th, 2015. If trying to use 1 of these inserts with an existing rail, please contact customer service for more information

**TO ORDER WOOD UNITS, SPECIFY:**

1. Model Number
2. Finish

**TO ORDER LW UNITS, SPECIFY:**

1. Model Number
2. Laminate Shelf Color
3. Finish Wall Color

**TO ORDER LAMINATE UNITS, SPECIFY:**

1. Model Number
2. Laminate Shelf Color
3. Laminate Wall Color

**TO ORDER WL UNITS, SPECIFY:**

1. Model Number
2. Wood Shelf Finish
3. Laminate Wall Color

**SAMPLE MODEL NUMBERS:**

11N3636SH4W MH  
 11N3636SH4LW 462 CW  
 11N3636SH4L 405 478

- See pages 306-307 for all options available in Exhibit

MODEL NO./DESCRIPTION	LIST PRICE	DIMENSIONS					CARTONED WEIGHT	CUBIC FEET
		D	W	H	A	KW		
<b>COMPATIBLE WITH WAVEWORKS 68" HIGH WW AND EPIC 68" HIGH MODELS 36"H ORGANIZER SHELF INSERTS (CONTINUED)</b>								
11N3636SH4W Wood	\$ 1714	10½	35½	36	—	—	51 lbs.	3.5
11N3636SH4LW Laminate Shelves, Wood Wall	1714	10½	35½	36	—	—	51 lbs.	3.5
11N3636SH4L Laminate	1184	10½	35½	36	—	—	51 lbs.	3.5
11N3636SH4WL Wood Shelves, Laminate Wall	1714	10½	35½	36	—	—	51 lbs.	3.5
<hr/>								
11N4236SH4W Wood	\$ 1718	10½	41½	36	—	—	59 lbs.	4.1
11N4236SH4LW Laminate Shelves, Wood Wall	1718	10½	41½	36	—	—	59 lbs.	4.1
11N4236SH4L Laminate	1186	10½	41½	36	—	—	59 lbs.	4.1
11N4236SH4WL Wood Shelves, Laminate Wall	1718	10½	41½	36	—	—	59 lbs.	4.1
<hr/>								
11N4836SH4W Wood	\$ 1909	10½	47½	36	—	—	68 lbs.	4.6
11N4836SH4LW Laminate Shelves, Wood Wall	1909	10½	47½	36	—	—	68 lbs.	4.6
11N4836SH4L Laminate	1317	10½	47½	36	—	—	68 lbs.	4.6
11N4836SH4WL Wood Shelves, Laminate Wall	1909	10½	47½	36	—	—	68 lbs.	4.6
<hr/>								
11N5436SH4W Wood	\$ 2100	10½	53	36	—	—	76 lbs.	5.1
11N5436SH4LW Laminate Shelves, Wood Wall	2100	10½	53	36	—	—	76 lbs.	5.1
11N5436SH4L Laminate	1450	10½	53	36	—	—	76 lbs.	5.1
11N5436SH4WL Wood Shelves, Laminate Wall	2100	10½	53	36	—	—	76 lbs.	5.1
<hr/>								
11N6036SH4W Wood	\$ 2310	10½	59½	36	—	—	85 lbs.	5.6
11N6036SH4LW Laminate Shelves, Wood Wall	2310	10½	59½	36	—	—	85 lbs.	5.6
11N6036SH4L Laminate	1593	10½	59½	36	—	—	85 lbs.	5.6
11N6036SH4WL Wood Shelves, Laminate Wall	2310	10½	59½	36	—	—	85 lbs.	5.6

**ORGANIZER SHELF INSERTS (CONTINUED)**

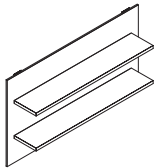
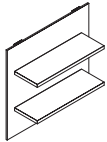

- Some assembly required
- "SH4" models have 2 shelves that align with the horizontal shelves of the "SH1" and "SH2" shelves
- The grain direction of all woodgrains will be horizontal (left to right) on the horizontal shelves
- Almond Horizontal (ADH), Portobello Horizontal (PBH), Portico Horizontal (PTH), Skyline Horizontal (SKH), Sonoma Horizontal (SMH), Designer White Linear Horizontal (491H), Cinder Linear Horizontal (492H) and Sable Horizontal (792H) laminates have horizontal grain on the wall insert and vertical shelves. All other woodgrains have vertical grain on the wall insert and vertical shelves
- Each horizontal shelf has a 50 lb. maximum limit

# EXHIBIT

## PRODUCT SPECIFICATIONS

- Each height of tack board, marker board, slat wall, and organizer shelf insert corresponds with a specific height of vertical storage in WaveWorks and Epic. See notation above models to see what model corresponds with appropriate height requirement
- Conference and training rooms commonly use 49" H inserts, but with Exhibit, you can use any of the 5 heights to achieve the customers needs
- As of April 20th, 2015, the inserts (Slat, Slat/Tack Combo, Insert Shelves, and TV Mount Inserts) will only be compatible with rails ordered on or after April 20th, 2015. If trying to use 1 of these inserts with an existing rail, please contact customer service for more information

## TO ORDER WOOD UNITS, SPECIFY:

1. Model Number
2. Shelf Height (SH6 models only)
3. Finish

## TO ORDER LW UNITS, SPECIFY:

1. Model Number
2. Shelf Height (SH6 models only)
3. Laminate Shelf Color
4. Finish Wall Color

## TO ORDER LAMINATE UNITS, SPECIFY:

1. Model Number
2. Shelf Height (SH6 models only)
3. Laminate Shelf Color
4. Laminate Wall Color

## TO ORDER WL UNITS, SPECIFY:

1. Model Number
2. Shelf Height (SH6 models only)
3. Wood Shelf Finish
4. Laminate Wall Color

## SAMPLE MODEL NUMBERS:

11N3636SH6W A MH  
 11N3636SH6LW A 462 CW  
 11N3636SH6L A 405 478

- See pages 306-307 for all options available in Exhibit

## ORGANIZER SHELF INSERTS (CONTINUED)

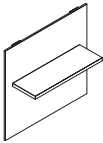

MODEL NO./DESCRIPTION		LIST PRICE	DIMENSIONS					CARTONED WEIGHT	CUBIC FEET
			D	W	H	A	KW		
<b>COMPATIBLE WITH WAVEWORKS 68" HIGH WW AND EPIC 68" HIGH MODELS</b>									
<b>36"H ORGANIZER SHELF INSERTS (CONTINUED)</b>									
11N3636SH6W	Wood	\$ 1675	10½	35½	36½	—	—	43 lbs.	3.5
11N3636SH6LW	Laminate Shelves, Wood Wall	1675	10½	35½	36½	—	—	43 lbs.	3.5
11N3636SH6L	Laminate	1155	10½	35½	36½	—	—	43 lbs.	3.5
11N3636SH6WL	Wood Shelves, Laminate Wall	1675	10½	35½	36½	—	—	49 lbs.	3.5
<hr/>									
11N4236SH6W	Wood	\$ 1679	10½	41½	36½	—	—	49 lbs.	4.1
11N4236SH6LW	Laminate Shelves, Wood Wall	1679	10½	41½	36½	—	—	49 lbs.	4.1
11N4236SH6L	Laminate	1158	10½	41½	36½	—	—	49 lbs.	4.1
11N4236SH6WL	Wood Shelves, Laminate Wall	1679	10½	41½	36½	—	—	49 lbs.	4.1
<hr/>									
11N4836SH6W	Wood	\$ 1865	10½	47½	36½	—	—	56 lbs.	4.6
11N4836SH6LW	Laminate Shelves, Wood Wall	1865	10½	47½	36½	—	—	56 lbs.	4.6
11N4836SH6L	Laminate	1286	10½	47½	36½	—	—	56 lbs.	4.6
11N4836SH6WL	Wood Shelves, Laminate Wall	1865	10½	47½	36½	—	—	56 lbs.	4.6
<hr/>									
11N5436SH6W	Wood	\$ 2052	10½	53½	36½	—	—	63 lbs.	5.1
11N5436SH6LW	Laminate Shelves, Wood Wall	2052	10½	53½	36½	—	—	63 lbs.	5.1
11N5436SH6L	Laminate	1415	10½	53½	36½	—	—	63 lbs.	5.1
11N5436SH6WL	Wood Shelves, Laminate Wall	2052	10½	53½	36½	—	—	63 lbs.	5.1
<hr/>									
11N6036SH6W	Wood	\$ 2256	10½	59½	36½	—	—	69 lbs.	5.6
11N6036SH6LW	Laminate Shelves, Wood Wall	2256	10½	59½	36½	—	—	69 lbs.	5.6
11N6036SH6L	Laminate	1557	10½	59½	36½	—	—	69 lbs.	5.6
11N6036SH6WL	Wood Shelves, Laminate Wall	2256	10½	59½	36½	—	—	69 lbs.	5.6

- Some assembly required
- "SH6" 36"/37" high models have 1 shelf that can be configured to align with the bottom of a 13" or 18" overhead
- The grain direction of all woodgrains will be horizontal (left to right) on the horizontal shelves
- Almond Horizontal (ADH), Portobello Horizontal (PBH), Portico Horizontal (PTH), Skyline Horizontal (SKH), Sonoma Horizontal (SMH), Designer White Linear Horizontal (491H), Cinder Linear Horizontal (492H) and Sable Horizontal (792H) laminates have horizontal grain on the wall insert and vertical shelves. All other woodgrains have vertical grain on the wall insert and vertical shelves
- Each horizontal shelf has a 50 lb. maximum limit

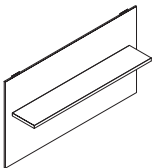

**PRODUCT SPECIFICATIONS**

- Each height of tack board, marker board, slat wall, and organizer shelf insert corresponds with a specific height of vertical storage in WaveWorks and Epic. See notation above models to see what model corresponds with appropriate height requirement
- Conference and training rooms commonly use 49" H inserts, but with Exhibit, you can use any of the 5 heights to achieve the customers needs
- As of April 20th, 2015, the inserts (Slat, Slat/Tack Combo, Insert Shelves, and TV Mount Inserts) will only be compatible with rails ordered on or after April 20th, 2015. If trying to use 1 of these inserts with an existing rail, please contact customer service for more information

**TO ORDER WOOD UNITS, SPECIFY:**

1. Model Number
2. Finish

**TO ORDER LW UNITS, SPECIFY:**

1. Model Number
2. Laminate Shelf Color
3. Finish Wall Color

**TO ORDER LAMINATE UNITS, SPECIFY:**

1. Model Number
2. Laminate Shelf Color
3. Laminate Wall Color

**TO ORDER WL UNITS, SPECIFY:**

1. Model Number
2. Wood Shelf Finish
3. Laminate Wall Color

**SAMPLE MODEL NUMBERS:**

11N3637SH1W MH  
 11N3637SH1LW 462 CW  
 11N3637SH1L 405 478

- See pages 306-307 for all options available in Exhibit

MODEL NO./DESCRIPTION	LIST PRICE	DIMENSIONS					CARTONED WEIGHT	CUBIC FEET
		D	W	H	A	KW		
<b>ORGANIZER SHELF INSERTS (CONTINUED)</b>								
<b>COMPATIBLE WITH WAVEWORKS 69" HIGH WVN MODELS 37"H ORGANIZER SHELF INSERTS</b>								
11N3637SH1W Wood	\$ 1972	10½	35½	37	—	—	51 lbs.	3.4
11N3637SH1LW Laminate Shelves, Wood Wall	1972	10½	35½	37	—	—	51 lbs.	3.4
11N3637SH1L Laminate	1358	10½	35½	37	—	—	51 lbs.	3.4
11N3637SH1WL Wood Shelves, Laminate Wall	1972	10½	35½	37	—	—	51 lbs.	3.4
<hr/>								
11N4237SH1W Wood	\$ 1975	10½	41½	37	—	—	57 lbs.	3.6
11N4237SH1LW Laminate Shelves, Wood Wall	1975	10½	41½	37	—	—	57 lbs.	3.6
11N4237SH1L Laminate	1360	10½	41½	37	—	—	57 lbs.	3.6
11N4237SH1WL Wood Shelves, Laminate Wall	1975	10½	41½	37	—	—	57 lbs.	3.6
<hr/>								
11N4837SH1W Wood	\$ 2194	10½	47½	37	—	—	62 lbs.	3.9
11N4837SH1LW Laminate Shelves, Wood Wall	2194	10½	47½	37	—	—	62 lbs.	3.9
11N4837SH1L Laminate	1513	10½	47½	37	—	—	62 lbs.	3.9
11N4837SH1WL Wood Shelves, Laminate Wall	2194	10½	47½	37	—	—	62 lbs.	3.9
<hr/>								
11N5437SH1W Wood	\$ 2413	10½	53	37	—	—	68 lbs.	4.1
11N5437SH1LW Laminate Shelves, Wood Wall	2413	10½	53	37	—	—	68 lbs.	4.1
11N5437SH1L Laminate	1665	10½	53	37	—	—	68 lbs.	4.1
11N5437SH1WL Wood Shelves, Laminate Wall	2413	10½	53	37	—	—	68 lbs.	4.1
<hr/>								
11N6037SH1W Wood	\$ 2655	10½	59½	37	—	—	74 lbs.	4.3
11N6037SH1LW Laminate Shelves, Wood Wall	2655	10½	59½	37	—	—	74 lbs.	4.3
11N6037SH1L Laminate	1831	10½	59½	37	—	—	74 lbs.	4.3
11N6037SH1WL Wood Shelves, Laminate Wall	2655	10½	59½	37	—	—	74 lbs.	4.3

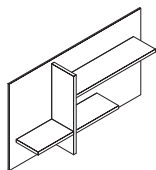
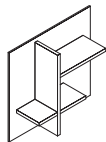

- Some assembly required
- 34", 36" and 37" high shelf inserts have 3 shelves
- The grain direction of all woodgrains will be horizontal (left to right) on the horizontal shelves
- Almond Horizontal (ADH), Portobello Horizontal (PBH), Portico Horizontal (PTH), Skyline Horizontal (SKH), Sonoma Horizontal (SMH), Designer White Linear Horizontal (491H), Cinder Linear Horizontal (492H) and Sable Horizontal (792H) laminates have horizontal grain on the wall insert and vertical shelves. All other woodgrains have vertical grain on the wall insert and vertical shelves
- Each horizontal shelf has a 50 lb. maximum limit

# EXHIBIT

## PRODUCT SPECIFICATIONS

- Each height of tack board, marker board, slat wall, and organizer shelf insert corresponds with a specific height of vertical storage in WaveWorks and Epic. See notation above models to see what model corresponds with appropriate height requirement
- Conference and training rooms commonly use 49" H inserts, but with Exhibit, you can use any of the 5 heights to achieve the customers needs
- As of April 20th, 2015, the inserts (Slat, Slat/Tack Combo, Insert Shelves, and TV Mount Inserts) will only be compatible with rails ordered on or after April 20th, 2015. If trying to use 1 of these inserts with an existing rail, please contact customer service for more information

## TO ORDER WOOD UNITS, SPECIFY:

1. Model Number
2. Finish

## TO ORDER LW UNITS, SPECIFY:

1. Model Number
2. Laminate Shelf Color
3. Finish Wall Color

## TO ORDER LAMINATE UNITS, SPECIFY:

1. Model Number
2. Laminate Shelf Color
3. Laminate Wall Color

## TO ORDER WL UNITS, SPECIFY:

1. Model Number
2. Wood Shelf Finish
3. Laminate Wall Color

## SAMPLE MODEL NUMBERS:

11N3637SH2W MH  
 11N3637SH2LW 462 CW  
 11N3637SH2L 405 478

- See pages 306-307 for all options available in Exhibit

MODEL NO./DESCRIPTION	LIST PRICE	DIMENSIONS					CARTONED WEIGHT	CUBIC FEET
		D	W	H	A	KW		
<b>ORGANIZER SHELF INSERTS (CONTINUED)</b>								
<b>COMPATIBLE WITH WAVEWORKS 69" HIGH WVN MODELS</b>								
<b>37"H ORGANIZER SHELF INSERTS (CONTINUED)</b>								
11N3637SH2W Wood	\$ 1972	10½	35½	37	—	—	51 lbs.	3.4
11N3637SH2LW Laminate Shelves, Wood Wall	1972	10½	35½	37	—	—	51 lbs.	3.4
11N3637SH2L Laminate	1358	10½	35½	37	—	—	51 lbs.	3.4
11N3637SH2WL Wood Shelves, Laminate Wall	1972	10½	35½	37	—	—	51 lbs.	3.4
<hr/>								
11N4237SH2W Wood	\$ 1975	10½	41½	37	—	—	57 lbs.	3.6
11N4237SH2LW Laminate Shelves, Wood Wall	1975	10½	41½	37	—	—	57 lbs.	3.6
11N4237SH2L Laminate	1360	10½	41½	37	—	—	57 lbs.	3.6
11N4237SH2WL Wood Shelves, Laminate Wall	1975	10½	41½	37	—	—	57 lbs.	3.6
<hr/>								
11N4837SH2W Wood	\$ 2194	10½	47½	37	—	—	62 lbs.	3.9
11N4837SH2LW Laminate Shelves, Wood Wall	2194	10½	47½	37	—	—	62 lbs.	3.9
11N4837SH2L Laminate	1513	10½	47½	37	—	—	62 lbs.	3.9
11N4837SH2WL Wood Shelves, Laminate Wall	2194	10½	47½	37	—	—	62 lbs.	3.9
<hr/>								
11N5437SH2W Wood	\$ 2413	10½	53%	37	—	—	68 lbs.	4.1
11N5437SH2LW Laminate Shelves, Wood Wall	2413	10½	53%	37	—	—	68 lbs.	4.1
11N5437SH2L Laminate	1665	10½	53%	37	—	—	68 lbs.	4.1
11N5437SH2WL Wood Shelves, Laminate Wall	2413	10½	53%	37	—	—	68 lbs.	4.1
<hr/>								
11N6037SH2W Wood	\$ 2655	10½	59½	37	—	—	74 lbs.	4.3
11N6037SH2LW Laminate Shelves, Wood Wall	2655	10½	59½	37	—	—	74 lbs.	4.3
11N6037SH2L Laminate	1831	10½	59½	37	—	—	74 lbs.	4.3
11N6037SH2WL Wood Shelves, Laminate Wall	2655	10½	59½	37	—	—	74 lbs.	4.3

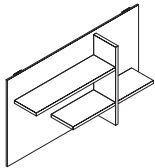
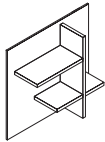

- Some assembly required
- "SH2" shelves are a mirrored version of the "SH1" shelves
- The grain direction of all woodgrains will be horizontal (left to right) on the horizontal shelves
- Almond Horizontal (ADH), Portobello Horizontal (PBH), Portico Horizontal (PTH), Skyline Horizontal (SKH), Sonoma Horizontal (SMH), Designer White Linear Horizontal (491H), Cinder Linear Horizontal (492H) and Sable Horizontal (792H) laminates have horizontal grain on the wall insert and vertical shelves. All other woodgrains have vertical grain on the wall insert and vertical shelves
- Each horizontal shelf has a 50 lb. maximum limit

**PRODUCT SPECIFICATIONS**

- Each height of tack board, marker board, slat wall, and organizer shelf insert corresponds with a specific height of vertical storage in WaveWorks and Epic. See notation above models to see what model corresponds with appropriate height requirement
- Conference and training rooms commonly use 49" H inserts, but with Exhibit, you can use any of the 5 heights to achieve the customers needs
- As of April 20th, 2015, the inserts (Slat, Slat/Tack Combo, Insert Shelves, and TV Mount Inserts) will only be compatible with rails ordered on or after April 20th, 2015. If trying to use 1 of these inserts with an existing rail, please contact customer service for more information

**TO ORDER WOOD UNITS, SPECIFY:**

1. Model Number
2. Finish

**TO ORDER LW UNITS, SPECIFY:**

1. Model Number
2. Laminate Shelf Color
3. Finish Wall Color

**TO ORDER LAMINATE UNITS, SPECIFY:**

1. Model Number
2. Laminate Shelf Color
3. Laminate Wall Color

**TO ORDER WL UNITS, SPECIFY:**

1. Model Number
2. Wood Shelf Finish
3. Laminate Wall Color

**SAMPLE MODEL NUMBERS:**

11N3637SH3W MH  
 11N3637SH3LW 462 CW  
 11N3637SH3L 405 478

- See pages 306-307 for all options available in Exhibit

MODEL NO./DESCRIPTION	LIST PRICE	DIMENSIONS					CARTONED WEIGHT	CUBIC FEET
		D	W	H	A	KW		
<b>ORGANIZER SHELF INSERTS (CONTINUED)</b>								
<b>COMPATIBLE WITH WAVEWORKS 69" HIGH WVN MODELS 37"H ORGANIZER SHELF INSERTS (CONTINUED)</b>								
11N3637SH3W Wood	\$ 1675	10½	35½	37	—	—	43 lbs.	3.6
11N3637SH3LW Laminate Shelves, Wood Wall	1675	10½	35½	37	—	—	43 lbs.	3.6
11N3637SH3L Laminate	1155	10½	35½	37	—	—	43 lbs.	3.6
11N3637SH3WL Wood Shelves, Laminate Wall	1675	10½	35½	37	—	—	43 lbs.	3.6
<hr/>								
11N4237SH3W Wood	\$ 1679	10½	41½	37	—	—	50 lbs.	4.1
11N4237SH3LW Laminate Shelves, Wood Wall	1679	10½	41½	37	—	—	50 lbs.	4.1
11N4237SH3L Laminate	1158	10½	41½	37	—	—	50 lbs.	4.1
11N4237SH3WL Wood Shelves, Laminate Wall	1679	10½	41½	37	—	—	50 lbs.	4.1
<hr/>								
11N4837SH3W Wood	\$ 1865	10½	47½	37	—	—	56 lbs.	4.6
11N4837SH3LW Laminate Shelves, Wood Wall	1865	10½	47½	37	—	—	56 lbs.	4.6
11N4837SH3L Laminate	1286	10½	47½	37	—	—	56 lbs.	4.6
11N4837SH3WL Wood Shelves, Laminate Wall	1865	10½	47½	37	—	—	56 lbs.	4.6
<hr/>								
11N5437SH3W Wood	\$ 2052	10½	53	37	—	—	63 lbs.	5.1
11N5437SH3LW Laminate Shelves, Wood Wall	2052	10½	53	37	—	—	63 lbs.	5.1
11N5437SH3L Laminate	1415	10½	53	37	—	—	63 lbs.	5.1
11N5437SH3WL Wood Shelves, Laminate Wall	2052	10½	53	37	—	—	63 lbs.	5.1
<hr/>								
11N6037SH3W Wood	\$ 2256	10½	59½	37	—	—	70 lbs.	5.7
11N6037SH3LW Laminate Shelves, Wood Wall	2256	10½	59½	37	—	—	70 lbs.	5.7
11N6037SH3L Laminate	1557	10½	59½	37	—	—	70 lbs.	5.7
11N6037SH3WL Wood Shelves, Laminate Wall	2256	10½	59½	37	—	—	70 lbs.	5.7

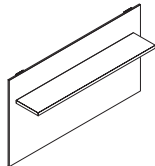
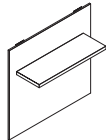

- Some assembly required
- "SH3" models have 1 shelf that aligns with the top shelf of the "SH1" and "SH2" shelves
- The grain direction of all woodgrains will be horizontal (left to right) on the horizontal shelves
- Almond Horizontal (ADH), Portobello Horizontal (PBH), Portico Horizontal (PTH), Skyline Horizontal (SKH), Sonoma Horizontal (SMH), Designer White Linear Horizontal (491H), Cinder Linear Horizontal (492H) and Sable Horizontal (792H) laminates have horizontal grain on the wall insert and vertical shelves. All other woodgrains have vertical grain on the wall insert and vertical shelves
- Each horizontal shelf has a 50 lb. maximum limit

# EXHIBIT

## PRODUCT SPECIFICATIONS

- Each height of tack board, marker board, slat wall, and organizer shelf insert corresponds with a specific height of vertical storage in WaveWorks and Epic. See notation above models to see what model corresponds with appropriate height requirement
- Conference and training rooms commonly use 49" H inserts, but with Exhibit, you can use any of the 5 heights to achieve the customers needs
- As of April 20th, 2015, the inserts (Slat, Slat/Tack Combo, Insert Shelves, and TV Mount Inserts) will only be compatible with rails ordered on or after April 20th, 2015. If trying to use 1 of these inserts with an existing rail, please contact customer service for more information

## TO ORDER WOOD UNITS, SPECIFY:

1. Model Number
2. Finish

## TO ORDER LW UNITS, SPECIFY:

1. Model Number
2. Laminate Shelf Color
3. Finish Wall Color

## TO ORDER LAMINATE UNITS, SPECIFY:

1. Model Number
2. Laminate Shelf Color
3. Laminate Wall Color

## TO ORDER WL UNITS, SPECIFY:

1. Model Number
2. Wood Shelf Finish
3. Laminate Wall Color

## SAMPLE MODEL NUMBERS:

11N3637SH4W MH  
 11N3637SH4LW 462 CW  
 11N3637SH4L 405 478

- See pages 306-307 for all options available in Exhibit

MODEL NO./DESCRIPTION	LIST PRICE	DIMENSIONS					CARTONED WEIGHT	CUBIC FEET
		D	W	H	A	KW		
<b>COMPATIBLE WITH WAVEWORKS 69" HIGH WVN MODELS</b>								
<b>37"H ORGANIZER SHELF INSERTS (CONTINUED)</b>								
11N3637SH4W Wood	\$ 1714	10½	35½	37	—	—	51 lbs.	3.6
11N3637SH4LW Laminate Shelves, Wood Wall	1714	10½	35½	37	—	—	51 lbs.	3.6
11N3637SH4L Laminate	1184	10½	35½	37	—	—	51 lbs.	3.6
11N3637SH4WL Wood Shelves, Laminate Wall	1714	10½	35½	37	—	—	51 lbs.	3.6
<hr/>								
11N4237SH4W Wood	\$ 1718	10½	41½	37	—	—	60 lbs.	4.1
11N4237SH4LW Laminate Shelves, Wood Wall	1718	10½	41½	37	—	—	60 lbs.	4.1
11N4237SH4L Laminate	1186	10½	41½	37	—	—	60 lbs.	4.1
11N4237SH4WL Wood Shelves, Laminate Wall	1718	10½	41½	37	—	—	60 lbs.	4.1
<hr/>								
11N4837SH4W Wood	\$ 1909	10½	47½	37	—	—	68 lbs.	4.6
11N4837SH4LW Laminate Shelves, Wood Wall	1909	10½	47½	37	—	—	68 lbs.	4.6
11N4837SH4L Laminate	1317	10½	47½	37	—	—	68 lbs.	4.6
11N4837SH4WL Wood Shelves, Laminate Wall	1909	10½	47½	37	—	—	68 lbs.	4.6
<hr/>								
11N5437SH4W Wood	\$ 2100	10½	53	37	—	—	77 lbs.	5.1
11N5437SH4LW Laminate Shelves, Wood Wall	2100	10½	53	37	—	—	77 lbs.	5.1
11N5437SH4L Laminate	1450	10½	53	37	—	—	77 lbs.	5.1
11N5437SH4WL Wood Shelves, Laminate Wall	2100	10½	53	37	—	—	77 lbs.	5.1
<hr/>								
11N6037SH4W Wood	\$ 2310	10½	59½	37	—	—	85 lbs.	5.7
11N6037SH4LW Laminate Shelves, Wood Wall	2310	10½	59½	37	—	—	85 lbs.	5.7
11N6037SH4L Laminate	1593	10½	59½	37	—	—	85 lbs.	5.7
11N6037SH4WL Wood Shelves, Laminate Wall	2310	10½	59½	37	—	—	85 lbs.	5.7

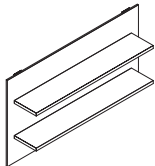
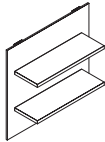

- Some assembly required
- "SH4" models have 2 shelves that align with the horizontal shelves of the "SH1" and "SH2" shelves
- The grain direction of all woodgrains will be horizontal (left to right) on the horizontal shelves
- Almond Horizontal (ADH), Portobello Horizontal (PBH), Portico Horizontal (PTH), Skyline Horizontal (SKH), Sonoma Horizontal (SMH), Designer White Linear Horizontal (491H), Cinder Linear Horizontal (492H) and Sable Horizontal (792H) laminates have horizontal grain on the wall insert and vertical shelves. All other woodgrains have vertical grain on the wall insert and vertical shelves
- Each horizontal shelf has a 50 lb. maximum limit

**PRODUCT SPECIFICATIONS**

- Each height of tack board, marker board, slat wall, and organizer shelf insert corresponds with a specific height of vertical storage in WaveWorks and Epic. See notation above models to see what model corresponds with appropriate height requirement
- Conference and training rooms commonly use 49" H inserts, but with Exhibit, you can use any of the 5 heights to achieve the customers needs
- As of April 20th, 2015, the inserts (Slat, Slat/Tack Combo, Insert Shelves, and TV Mount Inserts) will only be compatible with rails ordered on or after April 20th, 2015. If trying to use 1 of these inserts with an existing rail, please contact customer service for more information

**TO ORDER WOOD UNITS, SPECIFY:**

1. Model Number
2. Shelf Height (SH6 models only)
3. Finish

**TO ORDER LW UNITS, SPECIFY:**

1. Model Number
2. Shelf Height (SH6 models only)
3. Laminate Shelf Color
4. Finish Wall Color

**TO ORDER LAMINATE UNITS, SPECIFY:**

1. Model Number
2. Shelf Height (SH6 models only)
3. Laminate Shelf Color
4. Laminate Wall Color

**TO ORDER WL UNITS, SPECIFY:**

1. Model Number
2. Shelf Height (SH6 models only)
3. Wood Shelf Finish
4. Laminate Wall Color

**SAMPLE MODEL NUMBERS:**

11N3637SH6W A MH  
 11N3637SH6LW A 462 CW  
 11N3637SH6L A 405 478

• See pages 306-307 for all options available in Exhibit

MODEL NO./DESCRIPTION	LIST PRICE	DIMENSIONS					CARTONED WEIGHT	CUBIC FEET
		D	W	H	A	KW		
<b>ORGANIZER SHELF INSERTS (CONTINUED)</b>								
<b>COMPATIBLE WITH WAVEWORKS 69" HIGH WVN MODELS 37"H ORGANIZER SHELF INSERTS (CONTINUED)</b>								
11N3637SH6W Wood	\$ 1675	10½	35⅝	37	—	—	43 lbs.	3.6
11N3637SH6LW Laminate Shelves, Wood Wall	1675	10½	35⅝	37	—	—	43 lbs.	3.6
11N3637SH6L Laminate	1155	10½	35⅝	37	—	—	43 lbs.	3.6
11N3637SH6WL Wood Shelves, Laminate Wall	1675	10½	35⅝	37	—	—	43 lbs.	3.6
<hr/>								
11N4237SH6W Wood	\$ 1679	10½	41⅝	37	—	—	50 lbs.	4.1
11N4237SH6LW Laminate Shelves, Wood Wall	1679	10½	41⅝	37	—	—	50 lbs.	4.1
11N4237SH6L Laminate	1158	10½	41⅝	37	—	—	50 lbs.	4.1
11N4237SH6WL Wood Shelves, Laminate Wall	1679	10½	41⅝	37	—	—	50 lbs.	4.1
<hr/>								
11N4837SH6W Wood	\$ 1865	10½	47⅝	37	—	—	56 lbs.	4.6
11N4837SH6LW Laminate Shelves, Wood Wall	1865	10½	47⅝	37	—	—	56 lbs.	4.6
11N4837SH6L Laminate	1286	10½	47⅝	37	—	—	56 lbs.	4.6
11N4837SH6WL Wood Shelves, Laminate Wall	1865	10½	47⅝	37	—	—	56 lbs.	4.6
<hr/>								
11N5437SH6W Wood	\$ 2052	10½	53⅝	37	—	—	63 lbs.	5.1
11N5437SH6LW Laminate Shelves, Wood Wall	2052	10½	53⅝	37	—	—	63 lbs.	5.1
11N5437SH6L Laminate	1415	10½	53⅝	37	—	—	63 lbs.	5.1
11N5437SH6WL Wood Shelves, Laminate Wall	2052	10½	53⅝	37	—	—	63 lbs.	5.1
<hr/>								
11N6037SH6W Wood	\$ 2256	10½	59⅝	37	—	—	70 lbs.	5.7
11N6037SH6LW Laminate Shelves, Wood Wall	2256	10½	59⅝	37	—	—	70 lbs.	5.7
11N6037SH6L Laminate	1557	10½	59⅝	37	—	—	70 lbs.	5.7
11N6037SH6WL Wood Shelves, Laminate Wall	2256	10½	59⅝	37	—	—	70 lbs.	5.7

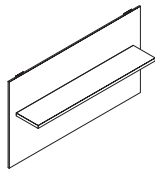
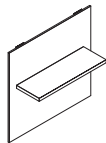

- Some assembly required
- "SH6" 36"/37" high models have 1 shelf that can be configured to align with the bottom of a 13" or 18" overhead
- The grain direction of all woodgrains will be horizontal (left to right) on the horizontal shelves
- Almond Horizontal (ADH), Portobello Horizontal (PBH), Portico Horizontal (PTH), Skyline Horizontal (SKH), Sonoma Horizontal (SMH), Designer White Linear Horizontal (491H), Cinder Linear Horizontal (492H) and Sable Horizontal (792H) laminates have horizontal grain on the wall insert and vertical shelves. All other woodgrains have vertical grain on the wall insert and vertical shelves
- Each horizontal shelf has a 50 lb. maximum limit

# EXHIBIT

## PRODUCT SPECIFICATIONS

- Each height of tack board, marker board, slat wall, and organizer shelf insert corresponds with a specific height of vertical storage in WaveWorks and Epic. See notation above models to see what model corresponds with appropriate height requirement
- Conference and training rooms commonly use 49" H inserts, but with Exhibit, you can use any of the 5 heights to achieve the customers needs
- As of April 20th, 2015, the inserts (Slat, Slat/Tack Combo, Insert Shelves, and TV Mount Inserts) will only be compatible with rails ordered on or after April 20th, 2015. If trying to use 1 of these inserts with an existing rail, please contact customer service for more information

## TO ORDER WOOD UNITS, SPECIFY:

1. Model Number
2. Finish

## TO ORDER LW UNITS, SPECIFY:

1. Model Number
2. Laminate Shelf Color
3. Finish Wall Color

## TO ORDER LAMINATE UNITS, SPECIFY:

1. Model Number
2. Laminate Shelf Color
3. Laminate Wall Color

## TO ORDER WL UNITS, SPECIFY:

1. Model Number
2. Wood Shelf Finish
3. Laminate Wall Color

## SAMPLE MODEL NUMBERS:

11N3648SH1W MH  
 11N3648SH1LW 462 CW  
 11N3648SH1L 405 478

- See pages 306-307 for all options available in Exhibit

MODEL NO./DESCRIPTION	LIST PRICE	DIMENSIONS					CARTONED WEIGHT	CUBIC FEET
		D	W	H	A	KW		
<b>ORGANIZER SHELF INSERTS (CONTINUED)</b>								
<b>COMPATIBLE WITH WAVEWORKS 79" HIGH WW MODELS 48"H ORGANIZER SHELF INSERTS</b>								
11N3648SH1W Wood	\$ 2329	10½	35⅝	48¾	—	—	69 lbs.	5.0
11N3648SH1LW Laminate Shelves, Wood Wall	2329	10½	35⅝	48¾	—	—	69 lbs.	5.0
11N3648SH1L Laminate	1605	10½	35⅝	48¾	—	—	69 lbs.	5.0
11N3648SH1WL Wood Shelves, Laminate Wall	2329	10½	35⅝	48¾	—	—	69 lbs.	5.0
<hr/>								
11N4248SH1W Wood	\$ 2332	10½	41⅞	48¾	—	—	77 lbs.	5.2
11N4248SH1LW Laminate Shelves, Wood Wall	2332	10½	41⅞	48¾	—	—	77 lbs.	5.2
11N4248SH1L Laminate	1607	10½	41⅞	48¾	—	—	77 lbs.	5.2
11N4248SH1WL Wood Shelves, Laminate Wall	2332	10½	41⅞	48¾	—	—	77 lbs.	5.2
<hr/>								
11N4848SH1W Wood	\$ 2589	10½	47⅞	48¾	—	—	85 lbs.	5.5
11N4848SH1LW Laminate Shelves, Wood Wall	2589	10½	47⅞	48¾	—	—	85 lbs.	5.5
11N4848SH1L Laminate	1785	10½	47⅞	48¾	—	—	85 lbs.	5.5
11N4848SH1WL Wood Shelves, Laminate Wall	2589	10½	47⅞	48¾	—	—	85 lbs.	5.5
<hr/>								
11N5448SH1W Wood	\$ 2850	10½	53¾	48¾	—	—	93 lbs.	5.8
11N5448SH1LW Laminate Shelves, Wood Wall	2850	10½	53¾	48¾	—	—	93 lbs.	5.8
11N5448SH1L Laminate	1965	10½	53¾	48¾	—	—	93 lbs.	5.8
11N5448SH1WL Wood Shelves, Laminate Wall	2850	10½	53¾	48¾	—	—	93 lbs.	5.8
<hr/>								
11N6048SH1W Wood	\$ 3132	10½	59⅞	48¾	—	—	101 lbs.	6.1
11N6048SH1LW Laminate Shelves, Wood Wall	3132	10½	59⅞	48¾	—	—	101 lbs.	6.1
11N6048SH1L Laminate	2160	10½	59⅞	48¾	—	—	101 lbs.	6.1
11N6048SH1WL Wood Shelves, Laminate Wall	3132	10½	59⅞	48¾	—	—	101 lbs.	6.1

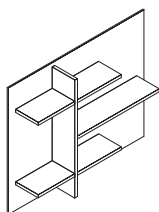
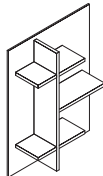

- Some assembly required
- 48" and 49" high shelf inserts have 5 shelves
- The grain direction of all woodgrains will be horizontal (left to right) on the horizontal shelves
- Almond Horizontal (ADH), Portobello Horizontal (PBH), Portico Horizontal (PTH), Skyline Horizontal (SKH), Sonoma Horizontal (SMH), Designer White Linear Horizontal (491H), Cinder Linear Horizontal (492H) and Sable Horizontal (792H) laminates have horizontal grain on the wall insert and vertical shelves. All other woodgrains have vertical grain on the wall insert and vertical shelves
- Each horizontal shelf has a 50 lb. maximum limit



**PRODUCT SPECIFICATIONS**

- Each height of tack board, marker board, slat wall, and organizer shelf insert corresponds with a specific height of vertical storage in WaveWorks and Epic. See notation above models to see what model corresponds with appropriate height requirement
- Conference and training rooms commonly use 49" H inserts, but with Exhibit, you can use any of the 5 heights to achieve the customers needs
- As of April 20th, 2015, the inserts (Slat, Slat/Tack Combo, Insert Shelves, and TV Mount Inserts) will only be compatible with rails ordered on or after April 20th, 2015. If trying to use 1 of these inserts with an existing rail, please contact customer service for more information

**TO ORDER WOOD UNITS, SPECIFY:**

1. Model Number
2. Finish

**TO ORDER LW UNITS, SPECIFY:**

1. Model Number
2. Laminate Shelf Color
3. Finish Wall Color

**TO ORDER LAMINATE UNITS, SPECIFY:**

1. Model Number
2. Laminate Shelf Color
3. Laminate Wall Color

**TO ORDER WL UNITS, SPECIFY:**

1. Model Number
2. Wood Shelf Finish
3. Laminate Wall Color

**SAMPLE MODEL NUMBERS:**

11N3648SH2W MH  
 11N3648SH2LW 462 CW  
 11N3648SH2L 405 478

- See pages 306-307 for all options available in Exhibit

MODEL NO./DESCRIPTION	LIST PRICE	DIMENSIONS					CARTONED WEIGHT	CUBIC FEET
		D	W	H	A	KW		
<b>ORGANIZER SHELF INSERTS (CONTINUED)</b>								
<b>COMPATIBLE WITH WAVEWORKS 79" HIGH WW MODELS 48"H ORGANIZER SHELF INSERTS (CONTINUED)</b>								
11N3648SH2W Wood	\$ 2329	10½	35½	48¾	—	—	69 lbs.	5.0
11N3648SH2LW Laminate Shelves, Wood Wall	2329	10½	35½	48¾	—	—	69 lbs.	5.0
11N3648SH2L Laminate	1605	10½	35½	48¾	—	—	69 lbs.	5.0
11N3648SH2WL Wood Shelves, Laminate Wall	2329	10½	35½	48¾	—	—	69 lbs.	5.0
<hr/>								
11N4248SH2W Wood	\$ 2332	10½	41½	48¾	—	—	77 lbs.	5.2
11N4248SH2LW Laminate Shelves, Wood Wall	2332	10½	41½	48¾	—	—	77 lbs.	5.2
11N4248SH2L Laminate	1607	10½	41½	48¾	—	—	77 lbs.	5.2
11N4248SH2WL Wood Shelves, Laminate Wall	2332	10½	41½	48¾	—	—	77 lbs.	5.2
<hr/>								
11N4848SH2W Wood	\$ 2589	10½	47½	48¾	—	—	85 lbs.	5.5
11N4848SH2LW Laminate Shelves, Wood Wall	2589	10½	47½	48¾	—	—	85 lbs.	5.5
11N4848SH2L Laminate	1785	10½	47½	48¾	—	—	85 lbs.	5.5
11N4848SH2WL Wood Shelves, Laminate Wall	2589	10½	47½	48¾	—	—	85 lbs.	5.5
<hr/>								
11N5448SH2W Wood	\$ 2850	10½	53¾	48¾	—	—	93 lbs.	5.8
11N5448SH2LW Laminate Shelves, Wood Wall	2850	10½	53¾	48¾	—	—	93 lbs.	5.8
11N5448SH2L Laminate	1965	10½	53¾	48¾	—	—	93 lbs.	5.8
11N5448SH2WL Wood Shelves, Laminate Wall	2850	10½	53¾	48¾	—	—	93 lbs.	5.8
<hr/>								
11N6048SH2W Wood	\$ 3132	10½	59½	48¾	—	—	101 lbs.	6.1
11N6048SH2LW Laminate Shelves, Wood Wall	3132	10½	59½	48¾	—	—	101 lbs.	6.1
11N6048SH2L Laminate	2160	10½	59½	48¾	—	—	101 lbs.	6.1
11N6048SH2WL Wood Shelves, Laminate Wall	3132	10½	59½	48¾	—	—	101 lbs.	6.1

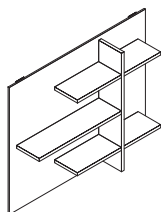
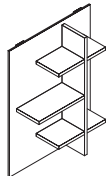

- Some assembly required
- "SH2" shelves are a mirrored version of the "SH1" shelves
- The grain direction of all woodgrains will be horizontal (left to right) on the horizontal shelves
- Almond Horizontal (ADH), Portobello Horizontal (PBH), Portico Horizontal (PTH), Skyline Horizontal (SKH), Sonoma Horizontal (SMH), Designer White Linear Horizontal (491H), Cinder Linear Horizontal (492H) and Sable Horizontal (792H) laminates have horizontal grain on the wall insert and vertical shelves. All other woodgrains have vertical grain on the wall insert and vertical shelves
- Each horizontal shelf has a 50 lb. maximum limit

EXHIBIT

# EXHIBIT

## PRODUCT SPECIFICATIONS

- Each height of tack board, marker board, slat wall, and organizer shelf insert corresponds with a specific height of vertical storage in WaveWorks and Epic. See notation above models to see what model corresponds with appropriate height requirement
- Conference and training rooms commonly use 49" H inserts, but with Exhibit, you can use any of the 5 heights to achieve the customers needs
- As of April 20th, 2015, the inserts (Slat, Slat/Tack Combo, Insert Shelves, and TV Mount Inserts) will only be compatible with rails ordered on or after April 20th, 2015. If trying to use 1 of these inserts with an existing rail, please contact customer service for more information

## TO ORDER WOOD UNITS, SPECIFY:

1. Model Number
2. Finish

## TO ORDER LW UNITS, SPECIFY:

1. Model Number
2. Laminate Shelf Color
3. Finish Wall Color

## TO ORDER LAMINATE UNITS, SPECIFY:

1. Model Number
2. Laminate Shelf Color
3. Laminate Wall Color

## TO ORDER WL UNITS, SPECIFY:

1. Model Number
2. Wood Shelf Finish
3. Laminate Wall Color

## SAMPLE MODEL NUMBERS:

11N3648SH3W MH  
 11N3648SH3LW 462 CW  
 11N3648SH3L 405 478

- See pages 306-307 for all options available in Exhibit

MODEL NO./DESCRIPTION	LIST PRICE	DIMENSIONS					CARTONED CUBIC	
		D	W	H	A	KW	WEIGHT	FEET
<b>ORGANIZER SHELF INSERTS (CONTINUED)</b>								
<b>COMPATIBLE WITH WAVEWORKS 79" HIGH WW MODELS 48"H ORGANIZER SHELF INSERTS (CONTINUED)</b>								
11N3648SH3W Wood	\$ 1978	10½	35½	48¾	—	—	53 lbs.	4.5
11N3648SH3LW Laminate Shelves, Wood Wall	1978	10½	35½	48¾	—	—	53 lbs.	4.5
11N3648SH3L Laminate	1362	10½	35½	48¾	—	—	53 lbs.	4.5
11N3648SH3WL Wood Shelves, Laminate Wall	1978	10½	35½	48¾	—	—	53 lbs.	4.5
<hr/>								
11N4248SH3W Wood	\$ 1981	10½	41½	48¾	—	—	61 lbs.	5.2
11N4248SH3LW Laminate Shelves, Wood Wall	1981	10½	41½	48¾	—	—	61 lbs.	5.2
11N4248SH3L Laminate	1367	10½	41½	48¾	—	—	61 lbs.	5.2
11N4248SH3WL Wood Shelves, Laminate Wall	1981	10½	41½	48¾	—	—	61 lbs.	5.2
<hr/>								
11N4848SH3W Wood	\$ 2200	10½	47½	48¾	—	—	69 lbs.	5.9
11N4848SH3LW Laminate Shelves, Wood Wall	2200	10½	47½	48¾	—	—	69 lbs.	5.9
11N4848SH3L Laminate	1517	10½	47½	48¾	—	—	69 lbs.	5.9
11N4848SH3WL Wood Shelves, Laminate Wall	2200	10½	47½	48¾	—	—	69 lbs.	5.9
<hr/>								
11N5448SH3W Wood	\$ 2423	10½	53¾	48¾	—	—	77 lbs.	6.5
11N5448SH3LW Laminate Shelves, Wood Wall	2423	10½	53¾	48¾	—	—	77 lbs.	6.5
11N5448SH3L Laminate	1669	10½	53¾	48¾	—	—	77 lbs.	6.5
11N5448SH3WL Wood Shelves, Laminate Wall	2423	10½	53¾	48¾	—	—	77 lbs.	6.5
<hr/>								
11N6048SH3W Wood	\$ 2662	10½	59½	48¾	—	—	86 lbs.	7.2
11N6048SH3LW Laminate Shelves, Wood Wall	2662	10½	59½	48¾	—	—	86 lbs.	7.2
11N6048SH3L Laminate	1837	10½	59½	48¾	—	—	86 lbs.	7.2
11N6048SH3WL Wood Shelves, Laminate Wall	2662	10½	59½	48¾	—	—	86 lbs.	7.2

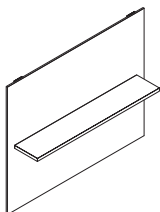
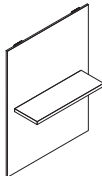

- Some assembly required
- "SH3" models have 1 shelf that aligns with the middle shelf of the "SH1" and "SH2" shelves
- The grain direction of all woodgrains will be horizontal (left to right) on the horizontal shelves
- Almond Horizontal (ADH), Portobello Horizontal (PBH), Portico Horizontal (PTH), Skyline Horizontal (SKH), Sonoma Horizontal (SMH), Designer White Linear Horizontal (491H), Cinder Linear Horizontal (492H) and Sable Horizontal (792H) laminates have horizontal grain on the wall insert and vertical shelves. All other woodgrains have vertical grain on the wall insert and vertical shelves
- Each horizontal shelf has a 50 lb. maximum limit

**PRODUCT SPECIFICATIONS**

- Each height of tack board, marker board, slat wall, and organizer shelf insert corresponds with a specific height of vertical storage in WaveWorks and Epic. See notation above models to see what model corresponds with appropriate height requirement
- Conference and training rooms commonly use 49" H inserts, but with Exhibit, you can use any of the 5 heights to achieve the customers needs
- As of April 20th, 2015, the inserts (Slat, Slat/Tack Combo, Insert Shelves, and TV Mount Inserts) will only be compatible with rails ordered on or after April 20th, 2015. If trying to use 1 of these inserts with an existing rail, please contact customer service for more information

**TO ORDER WOOD UNITS, SPECIFY:**

1. Model Number
2. Finish

**TO ORDER LW UNITS, SPECIFY:**

1. Model Number
2. Laminate Shelf Color
3. Finish Wall Color

**TO ORDER LAMINATE UNITS, SPECIFY:**

1. Model Number
2. Laminate Shelf Color
3. Laminate Wall Color

**TO ORDER WL UNITS, SPECIFY:**

1. Model Number
2. Wood Shelf Finish
3. Laminate Wall Color

**SAMPLE MODEL NUMBERS:**

11N3648SH4W MH  
 11N3648SH4LW 462 CW  
 11N3648SH4L 405 478

- See pages 306-307 for all options available in Exhibit

MODEL NO./DESCRIPTION	LIST PRICE	DIMENSIONS					CARTONED WEIGHT	CUBIC FEET
		D	W	H	A	KW		
<b>ORGANIZER SHELF INSERTS (CONTINUED)</b>								
<b>COMPATIBLE WITH WAVEWORKS 79" HIGH WW MODELS 48"H ORGANIZER SHELF INSERTS (CONTINUED)</b>								
11N3648SH4W Wood	\$ 2025	10½	35½	48¾	—	—	60 lbs.	4.5
11N3648SH4LW Laminate Shelves, Wood Wall	2025	10½	35½	48¾	—	—	60 lbs.	4.5
11N3648SH4L Laminate	1397	10½	35½	48¾	—	—	60 lbs.	4.5
11N3648SH4WL Wood Shelves, Laminate Wall	2025	10½	35½	48¾	—	—	60 lbs.	4.5
<hr/>								
11N4248SH4W Wood	\$ 2029	10½	41½	48¾	—	—	71 lbs.	5.2
11N4248SH4LW Laminate Shelves, Wood Wall	2029	10½	41½	48¾	—	—	71 lbs.	5.2
11N4248SH4L Laminate	1399	10½	41½	48¾	—	—	71 lbs.	5.2
11N4248SH4WL Wood Shelves, Laminate Wall	2029	10½	41½	48¾	—	—	71 lbs.	5.2
<hr/>								
11N4848SH4W Wood	\$ 2252	10½	47½	48¾	—	—	81 lbs.	5.9
11N4848SH4LW Laminate Shelves, Wood Wall	2252	10½	47½	48¾	—	—	81 lbs.	5.9
11N4848SH4L Laminate	1553	10½	47½	48¾	—	—	81 lbs.	5.9
11N4848SH4WL Wood Shelves, Laminate Wall	2252	10½	47½	48¾	—	—	81 lbs.	5.9
<hr/>								
11N5448SH4W Wood	\$ 2479	10½	53¾	48¾	—	—	90 lbs.	6.5
11N5448SH4LW Laminate Shelves, Wood Wall	2479	10½	53¾	48¾	—	—	90 lbs.	6.5
11N5448SH4L Laminate	1709	10½	53¾	48¾	—	—	90 lbs.	6.5
11N5448SH4WL Wood Shelves, Laminate Wall	2479	10½	53¾	48¾	—	—	90 lbs.	6.5
<hr/>								
11N6048SH4W Wood	\$ 2727	10½	59½	48¾	—	—	100 lbs.	7.2
11N6048SH4LW Laminate Shelves, Wood Wall	2727	10½	59½	48¾	—	—	100 lbs.	7.2
11N6048SH4L Laminate	1880	10½	59½	48¾	—	—	100 lbs.	7.2
11N6048SH4WL Wood Shelves, Laminate Wall	2727	10½	59½	48¾	—	—	100 lbs.	7.2

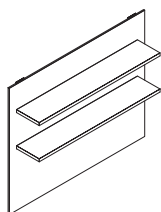
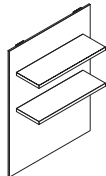

- Some assembly required
- "SH4" models have 2 shelves that align with the top shelves of the "SH1" and "SH2" shelves
- The grain direction of all woodgrains will be horizontal (left to right) on the horizontal shelves
- Almond Horizontal (ADH), Portobello Horizontal (PBH), Portico Horizontal (PTH), Skyline Horizontal (SKH), Sonoma Horizontal (SMH), Designer White Linear Horizontal (491H), Cinder Linear Horizontal (492H) and Sable Horizontal (792H) laminates have horizontal grain on the wall insert and vertical shelves. All other woodgrains have vertical grain on the wall insert and vertical shelves
- Each horizontal shelf has a 50 lb. maximum limit

# EXHIBIT

## PRODUCT SPECIFICATIONS

- Each height of tack board, marker board, slat wall, and organizer shelf insert corresponds with a specific height of vertical storage in WaveWorks and Epic. See notation above models to see what model corresponds with appropriate height requirement
- Conference and training rooms commonly use 49" H inserts, but with Exhibit, you can use any of the 5 heights to achieve the customers needs
- As of April 20th, 2015, the inserts (Slat, Slat/Tack Combo, Insert Shelves, and TV Mount Inserts) will only be compatible with rails ordered on or after April 20th, 2015. If trying to use 1 of these inserts with an existing rail, please contact customer service for more information

## TO ORDER WOOD UNITS, SPECIFY:

1. Model Number
2. Finish

## TO ORDER LW UNITS, SPECIFY:

1. Model Number
2. Laminate Shelf Color
3. Finish Wall Color

## TO ORDER LAMINATE UNITS, SPECIFY:

1. Model Number
2. Laminate Shelf Color
3. Laminate Wall Color

## TO ORDER WL UNITS, SPECIFY:

1. Model Number
2. Wood Shelf Finish
3. Laminate Wall Color

## SAMPLE MODEL NUMBERS:

11N3648SH5W MH  
 11N3648SH5LW 462 CW  
 11N3648SH5L 405 478

- See pages 306-307 for all options available in Exhibit

MODEL NO./DESCRIPTION	LIST PRICE	DIMENSIONS					CARTONED WEIGHT	CUBIC FEET
		D	W	H	A	KW		
<b>ORGANIZER SHELF INSERTS (CONTINUED)</b>								
<b>COMPATIBLE WITH WAVEWORKS 79" HIGH WW MODELS 48"H ORGANIZER SHELF INSERTS (CONTINUED)</b>								
11N3648SH5W Wood	\$ 2097	10½	35½	48¾	—	—	69 lbs.	4.5
11N3648SH5LW Laminate Shelves, Wood Wall	2097	10½	35½	48¾	—	—	69 lbs.	4.5
11N3648SH5L Laminate	1444	10½	35½	48¾	—	—	69 lbs.	4.5
11N3648SH5WL Wood Shelves, Laminate Wall	2097	10½	35½	48¾	—	—	69 lbs.	4.5
<hr/>								
11N4248SH5W Wood	\$ 2100	10½	41½	48¾	—	—	81 lbs.	5.2
11N4248SH5LW Laminate Shelves, Wood Wall	2100	10½	41½	48¾	—	—	81 lbs.	5.2
11N4248SH5L Laminate	1445	10½	41½	48¾	—	—	81 lbs.	5.2
11N4248SH5WL Wood Shelves, Laminate Wall	2100	10½	41½	48¾	—	—	81 lbs.	5.2
<hr/>								
11N4848SH5W Wood	\$ 2330	10½	47½	48¾	—	—	92 lbs.	5.9
11N4848SH5LW Laminate Shelves, Wood Wall	2330	10½	47½	48¾	—	—	92 lbs.	5.9
11N4848SH5L Laminate	1606	10½	47½	48¾	—	—	92 lbs.	5.9
11N4848SH5WL Wood Shelves, Laminate Wall	2330	10½	47½	48¾	—	—	92 lbs.	5.9
<hr/>								
11N5448SH5W Wood	\$ 2564	10½	53¾	48¾	—	—	104 lbs.	6.5
11N5448SH5LW Laminate Shelves, Wood Wall	2564	10½	53¾	48¾	—	—	104 lbs.	6.5
11N5448SH5L Laminate	1767	10½	53¾	48¾	—	—	104 lbs.	6.5
11N5448SH5WL Wood Shelves, Laminate Wall	2564	10½	53¾	48¾	—	—	104 lbs.	6.5
<hr/>								
11N6048SH5W Wood	\$ 2819	10½	59½	48¾	—	—	115 lbs.	7.2
11N6048SH5LW Laminate Shelves, Wood Wall	2819	10½	59½	48¾	—	—	115 lbs.	7.2
11N6048SH5L Laminate	1944	10½	59½	48¾	—	—	115 lbs.	7.2
11N6048SH5WL Wood Shelves, Laminate Wall	2819	10½	59½	48¾	—	—	115 lbs.	7.2

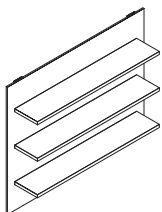
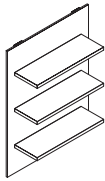

- Some assembly required
- "SH5" models have 3 shelves that align with the horizontal shelves of the "SH1" and "SH2" shelves
- The grain direction of all woodgrains will be horizontal (left to right) on the horizontal shelves
- Almond Horizontal (ADH), Portobello Horizontal (PBH), Portico Horizontal (PTH), Skyline Horizontal (SKH), Sonoma Horizontal (SMH), Designer White Linear Horizontal (491H), Cinder Linear Horizontal (492H) and Sable Horizontal (792H) laminates have horizontal grain on the wall insert and vertical shelves. All other woodgrains have vertical grain on the wall insert and vertical shelves
- Each horizontal shelf has a 50 lb. maximum limit

**PRODUCT SPECIFICATIONS**

- Each height of tack board, marker board, slat wall, and organizer shelf insert corresponds with a specific height of vertical storage in WaveWorks and Epic. See notation above models to see what model corresponds with appropriate height requirement
- Conference and training rooms commonly use 49" H inserts, but with Exhibit, you can use any of the 5 heights to achieve the customers needs
- As of April 20th, 2015, the inserts (Slat, Slat/Tack Combo, Insert Shelves, and TV Mount Inserts) will only be compatible with rails ordered on or after April 20th, 2015. If trying to use 1 of these inserts with an existing rail, please contact customer service for more information

**TO ORDER WOOD UNITS, SPECIFY:**

1. Model Number
2. Shelf Height (SH6 models only)
3. Finish

**TO ORDER LW UNITS, SPECIFY:**

1. Model Number
2. Shelf Height (SH6 models only)
3. Laminate Shelf Color
4. Finish Wall Color

**TO ORDER LAMINATE UNITS, SPECIFY:**

1. Model Number
2. Shelf Height (SH6 models only)
3. Laminate Shelf Color
4. Laminate Wall Color

**TO ORDER WL UNITS, SPECIFY:**

1. Model Number
2. Shelf Height (SH6 models only)
3. Wood Shelf Finish
4. Laminate Wall Color

**SAMPLE MODEL NUMBERS:**

11N3648SH6W B MH  
 11N3648SH6LW A 462 CW  
 11N3648SH6L B 405 478

• See pages 306-307 for all options available in Exhibit

MODEL NO./DESCRIPTION	LIST PRICE	DIMENSIONS					CARTONED WEIGHT	CUBIC FEET
		D	W	H	A	KW		
<b>ORGANIZER SHELF INSERTS (CONTINUED)</b>								
<b>COMPATIBLE WITH WAVEWORKS 79" HIGH WW MODELS 48"H ORGANIZER SHELF INSERTS (CONTINUED)</b>								
11N3648SH6W Wood	\$ 1978	10½	35½	48	—	—	53 lbs.	4.5
11N3648SH6LW Laminate Shelves, Wood Wall	1978	10½	35½	48	—	—	53 lbs.	4.5
11N3648SH6L Laminate	1362	10½	35½	48	—	—	53 lbs.	4.5
11N3648SH6WL Wood Shelves, Laminate Wall	1978	10½	35½	48	—	—	53 lbs.	4.5
<hr/>								
11N4248SH6W Wood	\$ 1981	10½	41½	48	—	—	61 lbs.	5.2
11N4248SH6LW Laminate Shelves, Wood Wall	1981	10½	41½	48	—	—	61 lbs.	5.2
11N4248SH6L Laminate	1367	10½	41½	48	—	—	61 lbs.	5.2
11N4248SH6WL Wood Shelves, Laminate Wall	1981	10½	41½	48	—	—	61 lbs.	5.2
<hr/>								
11N4848SH6W Wood	\$ 2200	10½	47½	48	—	—	69 lbs.	5.9
11N4848SH6LW Laminate Shelves, Wood Wall	2200	10½	47½	48	—	—	69 lbs.	5.9
11N4848SH6L Laminate	1517	10½	47½	48	—	—	69 lbs.	5.9
11N4848SH6WL Wood Shelves, Laminate Wall	2200	10½	47½	48	—	—	69 lbs.	5.9
<hr/>								
11N5448SH6W Wood	\$ 2423	10½	53	48	—	—	77 lbs.	6.5
11N5448SH6LW Laminate Shelves, Wood Wall	2423	10½	53	48	—	—	77 lbs.	6.5
11N5448SH6L Laminate	1669	10½	53	48	—	—	77 lbs.	6.5
11N5448SH6WL Wood Shelves, Laminate Wall	2423	10½	53	48	—	—	77 lbs.	6.5
<hr/>								
11N6048SH6W Wood	\$ 2662	10½	59½	48	—	—	86 lbs.	7.2
11N6048SH6LW Laminate Shelves, Wood Wall	2662	10½	59½	48	—	—	86 lbs.	7.2
11N6048SH6L Laminate	1837	10½	59½	48	—	—	86 lbs.	7.2
11N6048SH6WL Wood Shelves, Laminate Wall	2662	10½	59½	48	—	—	86 lbs.	7.2

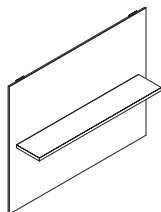
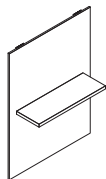

- Some assembly required
- "SH6" 48"/49" high models have 1 shelf that can be configured to align with the bottom of a 13", 18", 30" high overhead, or top shelf of the SH1/SH2 48"/49" inserts
- The grain direction of all woodgrains will be horizontal (left to right) on the horizontal shelves
- Almond Horizontal (ADH), Portobello Horizontal (PBH), Portico Horizontal (PTH), Skyline Horizontal (SKH), Sonoma Horizontal (SMH), Designer White Linear Horizontal (491H), Cinder Linear Horizontal (492H) and Sable Horizontal (792H) laminates have horizontal grain on the wall insert and vertical shelves. All other woodgrains have vertical grain on the wall insert and vertical shelves
- Each horizontal shelf has a 50 lb. maximum limit

# EXHIBIT

## PRODUCT SPECIFICATIONS

- Each height of tack board, marker board, slat wall, and organizer shelf insert corresponds with a specific height of vertical storage in WaveWorks and Epic. See notation above models to see what model corresponds with appropriate height requirement
- Conference and training rooms commonly use 49" H inserts, but with Exhibit, you can use any of the 5 heights to achieve the customers needs
- As of April 20th, 2015, the inserts (Slat, Slat/Tack Combo, Insert Shelves, and TV Mount Inserts) will only be compatible with rails ordered on or after April 20th, 2015. If trying to use 1 of these inserts with an existing rail, please contact customer service for more information

## TO ORDER WOOD UNITS, SPECIFY:

1. Model Number
2. Finish

## TO ORDER LW UNITS, SPECIFY:

1. Model Number
2. Laminate Shelf Color
3. Finish Wall Color

## TO ORDER LAMINATE UNITS, SPECIFY:

1. Model Number
2. Laminate Shelf Color
3. Laminate Wall Color

## TO ORDER WL UNITS, SPECIFY:

1. Model Number
2. Wood Shelf Finish
3. Laminate Wall Color

## SAMPLE MODEL NUMBERS:

11N3648SH7W MH  
 11N3648SH7LW 462 CW  
 11N3648SH7L 405 478

- See pages 306-307 for all options available in Exhibit

MODEL NO./DESCRIPTION	LIST PRICE	DIMENSIONS					CARTONED WEIGHT	CUBIC FEET
		D	W	H	A	KW		
<b>ORGANIZER SHELF INSERTS (CONTINUED)</b>								
<b>COMPATIBLE WITH WAVEWORKS 79" HIGH WW MODELS 48"H ORGANIZER SHELF INSERTS (CONTINUED)</b>								
11N3648SH7W Wood	\$ 2025	10½	35½	48¾	—	—	60 lbs.	4.5
11N3648SH7LW Laminate Shelves, Wood Wall	2025	10½	35½	48¾	—	—	60 lbs.	4.5
11N3648SH7L Laminate	1397	10½	35½	48¾	—	—	60 lbs.	4.5
11N3648SH7WL Wood Shelves, Laminate Wall	2025	10½	35½	48¾	—	—	60 lbs.	4.5
<hr/>								
11N4248SH7W Wood	\$ 2029	10½	41½	48¾	—	—	71 lbs.	5.2
11N4248SH7LW Laminate Shelves, Wood Wall	2029	10½	41½	48¾	—	—	71 lbs.	5.2
11N4248SH7L Laminate	1399	10½	41½	48¾	—	—	71 lbs.	5.2
11N4248SH7WL Wood Shelves, Laminate Wall	2029	10½	41½	48¾	—	—	71 lbs.	5.2
<hr/>								
11N4848SH7W Wood	\$ 2252	10½	47½	48¾	—	—	81 lbs.	5.9
11N4848SH7LW Laminate Shelves, Wood Wall	2252	10½	47½	48¾	—	—	81 lbs.	5.9
11N4848SH7L Laminate	1553	10½	47½	48¾	—	—	81 lbs.	5.9
11N4848SH7WL Wood Shelves, Laminate Wall	2252	10½	47½	48¾	—	—	81 lbs.	5.9
<hr/>								
11N5448SH7W Wood	\$ 2479	10½	53¾	48¾	—	—	90 lbs.	6.5
11N5448SH7LW Laminate Shelves, Wood Wall	2479	10½	53¾	48¾	—	—	90 lbs.	6.5
11N5448SH7L Laminate	1709	10½	53¾	48¾	—	—	90 lbs.	6.5
11N5448SH7WL Wood Shelves, Laminate Wall	2479	10½	53¾	48¾	—	—	90 lbs.	6.5
<hr/>								
11N6048SH7W Wood	\$ 2727	10½	59½	48¾	—	—	100 lbs.	7.2
11N6048SH7LW Laminate Shelves, Wood Wall	2727	10½	59½	48¾	—	—	100 lbs.	7.2
11N6048SH7L Laminate	1880	10½	59½	48¾	—	—	100 lbs.	7.2
11N6048SH7WL Wood Shelves, Laminate Wall	2727	10½	59½	48¾	—	—	100 lbs.	7.2

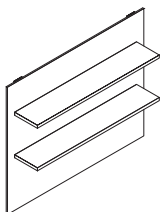
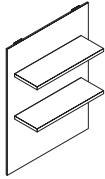

- Some assembly required
- "SH7" models have 2 shelves; the bottom shelf aligns with the bottom of a 30" overhead
- The grain direction of all woodgrains will be horizontal (left to right) on the horizontal shelves
- Almond Horizontal (ADH), Portobello Horizontal (PBH), Portico Horizontal (PTH), Skyline Horizontal (SKH), Sonoma Horizontal (SMH), Designer White Linear Horizontal (491H), Cinder Linear Horizontal (492H) and Sable Horizontal (792H) laminates have horizontal grain on the wall insert and vertical shelves. All other woodgrains have vertical grain on the wall insert and vertical shelves
- Each horizontal shelf has a 50 lb. maximum limit

**PRODUCT SPECIFICATIONS**

- Each height of tack board, marker board, slat wall, and organizer shelf insert corresponds with a specific height of vertical storage in WaveWorks and Epic. See notation above models to see what model corresponds with appropriate height requirement
- Conference and training rooms commonly use 49" H inserts, but with Exhibit, you can use any of the 5 heights to achieve the customers needs
- As of April 20th, 2015, the inserts (Slat, Slat/Tack Combo, Insert Shelves, and TV Mount Inserts) will only be compatible with rails ordered on or after April 20th, 2015. If trying to use 1 of these inserts with an existing rail, please contact customer service for more information

**TO ORDER WOOD UNITS, SPECIFY:**

1. Model Number
2. Finish

**TO ORDER LW UNITS, SPECIFY:**

1. Model Number
2. Laminate Shelf Color
3. Finish Wall Color

**TO ORDER LAMINATE UNITS, SPECIFY:**

1. Model Number
2. Laminate Shelf Color
3. Laminate Wall Color

**TO ORDER WL UNITS, SPECIFY:**

1. Model Number
2. Wood Shelf Finish
3. Laminate Wall Color

**SAMPLE MODEL NUMBERS:**

11N3649SH1W MH  
 11N3649SH1LW 462 CW  
 11N3649SH1L 405 478

- See pages 306-307 for all options available in Exhibit

MODEL NO./DESCRIPTION	LIST PRICE	DIMENSIONS					CARTONED WEIGHT	CUBIC FEET
		D	W	H	A	KW		
<b>ORGANIZER SHELF INSERTS (CONTINUED)</b>								
<b>COMPATIBLE WITH WAVEWORKS 80" HIGH WVN MODELS 49"H ORGANIZER SHELF INSERTS</b>								
11N3649SH1W Wood	\$ 2329	10½	35½	48½	—	—	69 lbs.	5.0
11N3649SH1LW Laminate Shelves, Wood Wall	2329	10½	35½	48½	—	—	69 lbs.	5.0
11N3649SH1L Laminate	1605	10½	35½	48½	—	—	69 lbs.	5.0
11N3649SH1WL Wood Shelves, Laminate Wall	2329	10½	35½	48½	—	—	69 lbs.	5.0
<hr/>								
11N4249SH1W Wood	\$ 2332	10½	41½	48½	—	—	77 lbs.	5.2
11N4249SH1LW Laminate Shelves, Wood Wall	2332	10½	41½	48½	—	—	77 lbs.	5.2
11N4249SH1L Laminate	1607	10½	41½	48½	—	—	77 lbs.	5.2
11N4249SH1WL Wood Shelves, Laminate Wall	2332	10½	41½	48½	—	—	77 lbs.	5.2
<hr/>								
11N4849SH1W Wood	\$ 2589	10½	47½	48½	—	—	85 lbs.	5.5
11N4849SH1LW Laminate Shelves, Wood Wall	2589	10½	47½	48½	—	—	85 lbs.	5.5
11N4849SH1L Laminate	1785	10½	47½	48½	—	—	85 lbs.	5.5
11N4849SH1WL Wood Shelves, Laminate Wall	2589	10½	47½	48½	—	—	85 lbs.	5.5
<hr/>								
11N5449SH1W Wood	\$ 2850	10½	53	48½	—	—	93 lbs.	5.8
11N5449SH1LW Laminate Shelves, Wood Wall	2850	10½	53	48½	—	—	93 lbs.	5.8
11N5449SH1L Laminate	1965	10½	53	48½	—	—	93 lbs.	5.8
11N5449SH1WL Wood Shelves, Laminate Wall	2850	10½	53	48½	—	—	93 lbs.	5.8
<hr/>								
11N6049SH1W Wood	\$ 3132	10½	59½	48½	—	—	101 lbs.	6.1
11N6049SH1LW Laminate Shelves, Wood Wall	3132	10½	59½	48½	—	—	101 lbs.	6.1
11N6049SH1L Laminate	2160	10½	59½	48½	—	—	101 lbs.	6.1
11N6049SH1WL Wood Shelves, Laminate Wall	3132	10½	59½	48½	—	—	101 lbs.	6.1

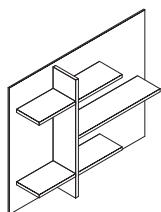
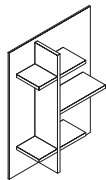

- Some assembly required
- 48" and 49" high shelf inserts have 5 shelves
- The grain direction of all woodgrains will be horizontal (left to right) on the horizontal shelves
- Almond Horizontal (ADH), Portobello Horizontal (PBH), Portico Horizontal (PTH), Skyline Horizontal (SKH), Sonoma Horizontal (SMH), Designer White Linear Horizontal (491H), Cinder Linear Horizontal (492H) and Sable Horizontal (792H) laminates have horizontal grain on the wall insert and vertical shelves. All other woodgrains have vertical grain on the wall insert and vertical shelves
- Each horizontal shelf has a 50 lb. maximum limit

# EXHIBIT

## PRODUCT SPECIFICATIONS

- Each height of tack board, marker board, slat wall, and organizer shelf insert corresponds with a specific height of vertical storage in WaveWorks and Epic. See notation above models to see what model corresponds with appropriate height requirement
- Conference and training rooms commonly use 49" H inserts, but with Exhibit, you can use any of the 5 heights to achieve the customers needs
- As of April 20th, 2015, the inserts (Slat, Slat/Tack Combo, Insert Shelves, and TV Mount Inserts) will only be compatible with rails ordered on or after April 20th, 2015. If trying to use 1 of these inserts with an existing rail, please contact customer service for more information

## TO ORDER WOOD UNITS, SPECIFY:

1. Model Number
2. Finish

## TO ORDER LW UNITS, SPECIFY:

1. Model Number
2. Laminate Shelf Color
3. Finish Wall Color

## TO ORDER LAMINATE UNITS, SPECIFY:

1. Model Number
2. Laminate Shelf Color
3. Laminate Wall Color

## TO ORDER WL UNITS, SPECIFY:

1. Model Number
2. Wood Shelf Finish
3. Laminate Wall Color

## SAMPLE MODEL NUMBERS:

11N3649SH2W MH  
 11N3649SH2LW 462 CW  
 11N3649SH2L 405 478

- See pages 306-307 for all options available in Exhibit

MODEL NO./DESCRIPTION	LIST PRICE	DIMENSIONS					CARTONED WEIGHT	CUBIC FEET
		D	W	H	A	KW		
<b>ORGANIZER SHELF INSERTS (CONTINUED)</b>								
<b>COMPATIBLE WITH WAVEWORKS 80" HIGH WVN MODELS</b>								
<b>49"H ORGANIZER SHELF INSERTS (CONTINUED)</b>								
11N3649SH2W Wood	\$ 2329	10½	35⅞	48⅜	—	—	69 lbs.	5.0
11N3649SH2LW Laminate Shelves, Wood Wall	2329	10½	35⅞	48⅜	—	—	69 lbs.	5.0
11N3649SH2L Laminate	1605	10½	35⅞	48⅜	—	—	69 lbs.	5.0
11N3649SH2WL Wood Shelves, Laminate Wall	2329	10½	35⅞	48⅜	—	—	69 lbs.	5.0
<hr/>								
11N4249SH2W Wood	\$ 2332	10½	41⅞	48⅜	—	—	77 lbs.	5.2
11N4249SH2LW Laminate Shelves, Wood Wall	2332	10½	41⅞	48⅜	—	—	77 lbs.	5.2
11N4249SH2L Laminate	1607	10½	41⅞	48⅜	—	—	77 lbs.	5.2
11N4249SH2WL Wood Shelves, Laminate Wall	2332	10½	41⅞	48⅜	—	—	77 lbs.	5.2
<hr/>								
11N4849SH2W Wood	\$ 2589	10½	47⅞	48⅜	—	—	85 lbs.	5.5
11N4849SH2LW Laminate Shelves, Wood Wall	2589	10½	47⅞	48⅜	—	—	85 lbs.	5.5
11N4849SH2L Laminate	1785	10½	47⅞	48⅜	—	—	85 lbs.	5.5
11N4849SH2WL Wood Shelves, Laminate Wall	2589	10½	47⅞	48⅜	—	—	85 lbs.	5.5
<hr/>								
11N5449SH2W Wood	\$ 2850	10½	53⅞	48⅜	—	—	93 lbs.	5.8
11N5449SH2LW Laminate Shelves, Wood Wall	2850	10½	53⅞	48⅜	—	—	93 lbs.	5.8
11N5449SH2L Laminate	1965	10½	53⅞	48⅜	—	—	93 lbs.	5.8
11N5449SH2WL Wood Shelves, Laminate Wall	2850	10½	53⅞	48⅜	—	—	93 lbs.	5.8
<hr/>								
11N6049SH2W Wood	\$ 3132	10½	59⅞	48⅜	—	—	101 lbs.	6.1
11N6049SH2LW Laminate Shelves, Wood Wall	3132	10½	59⅞	48⅜	—	—	101 lbs.	6.1
11N6049SH2L Laminate	2160	10½	59⅞	48⅜	—	—	101 lbs.	6.1
11N6049SH2WL Wood Shelves, Laminate Wall	3132	10½	59⅞	48⅜	—	—	101 lbs.	6.1

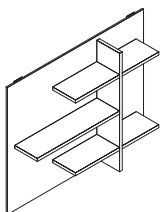
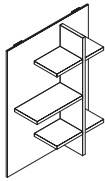

- Some assembly required
- "SH2" shelves are a mirrored version of the "SH1" shelves
- The grain direction of all woodgrains will be horizontal (left to right) on the horizontal shelves
- Almond Horizontal (ADH), Portobello Horizontal (PBH), Portico Horizontal (PTH), Skyline Horizontal (SKH), Sonoma Horizontal (SMH), Designer White Linear Horizontal (491H), Cinder Linear Horizontal (492H) and Sable Horizontal (792H) laminates have horizontal grain on the wall insert and vertical shelves. All other woodgrains have vertical grain on the wall insert and vertical shelves
- Each horizontal shelf has a 50 lb. maximum limit



**PRODUCT SPECIFICATIONS**

- Each height of tack board, marker board, slat wall, and organizer shelf insert corresponds with a specific height of vertical storage in WaveWorks and Epic. See notation above models to see what model corresponds with appropriate height requirement
- Conference and training rooms commonly use 49" H inserts, but with Exhibit, you can use any of the 5 heights to achieve the customers needs
- As of April 20th, 2015, the inserts (Slat, Slat/Tack Combo, Insert Shelves, and TV Mount Inserts) will only be compatible with rails ordered on or after April 20th, 2015. If trying to use 1 of these inserts with an existing rail, please contact customer service for more information

**TO ORDER WOOD UNITS, SPECIFY:**

1. Model Number
2. Finish

**TO ORDER LW UNITS, SPECIFY:**

1. Model Number
2. Laminate Shelf Color
3. Finish Wall Color

**TO ORDER LAMINATE UNITS, SPECIFY:**

1. Model Number
2. Laminate Shelf Color
3. Laminate Wall Color

**TO ORDER WL UNITS, SPECIFY:**

1. Model Number
2. Wood Shelf Finish
3. Laminate Wall Color

**SAMPLE MODEL NUMBERS:**

11N3649SH3W MH  
 11N3649SH3LW 462 CW  
 11N3649SH3L 405 478

- See pages 306-307 for all options available in Exhibit

MODEL NO./DESCRIPTION	LIST PRICE	DIMENSIONS					CARTONED WEIGHT	CUBIC FEET
		D	W	H	A	KW		
<b>ORGANIZER SHELF INSERTS (CONTINUED)</b>								
<b>COMPATIBLE WITH WAVEWORKS 80" HIGH WVN MODELS 49"H ORGANIZER SHELF INSERTS (CONTINUED)</b>								
11N3649SH3W Wood	\$ 1978	10½	35½	48½	—	—	53 lbs.	4.6
11N3649SH3LW Laminate Shelves, Wood Wall	1978	10½	35½	48½	—	—	53 lbs.	4.6
11N3649SH3L Laminate	1362	10½	35½	48½	—	—	53 lbs.	4.6
11N3649SH3WL Wood Shelves, Laminate Wall	1978	10½	35½	48½	—	—	53 lbs.	4.6
<hr/>								
11N4249SH3W Wood	\$ 1981	10½	41½	48½	—	—	61 lbs.	5.2
11N4249SH3LW Laminate Shelves, Wood Wall	1981	10½	41½	48½	—	—	61 lbs.	5.2
11N4249SH3L Laminate	1367	10½	41½	48½	—	—	61 lbs.	5.2
11N4249SH3WL Wood Shelves, Laminate Wall	1981	10½	41½	48½	—	—	61 lbs.	5.2
<hr/>								
11N4849SH3W Wood	\$ 2200	10½	47½	48½	—	—	69 lbs.	5.9
11N4849SH3LW Laminate Shelves, Wood Wall	2200	10½	47½	48½	—	—	69 lbs.	5.9
11N4849SH3L Laminate	1517	10½	47½	48½	—	—	69 lbs.	5.9
11N4849SH3WL Wood Shelves, Laminate Wall	2200	10½	47½	48½	—	—	69 lbs.	5.9
<hr/>								
11N5449SH3W Wood	\$ 2423	10½	53	48½	—	—	78 lbs.	6.6
11N5449SH3LW Laminate Shelves, Wood Wall	2423	10½	53	48½	—	—	78 lbs.	6.6
11N5449SH3L Laminate	1669	10½	53	48½	—	—	78 lbs.	6.6
11N5449SH3WL Wood Shelves, Laminate Wall	2423	10½	53	48½	—	—	78 lbs.	6.6
<hr/>								
11N6049SH3W Wood	\$ 2662	10½	59½	48½	—	—	86 lbs.	7.2
11N6049SH3LW Laminate Shelves, Wood Wall	2662	10½	59½	48½	—	—	86 lbs.	7.2
11N6049SH3L Laminate	1837	10½	59½	48½	—	—	86 lbs.	7.2
11N6049SH3WL Wood Shelves, Laminate Wall	2662	10½	59½	48½	—	—	86 lbs.	7.2

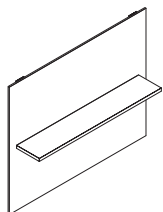
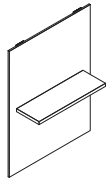

- Some assembly required
- "SH3" models have 1 shelf that aligns with the middle shelf of the "SH1" and "SH2" shelves
- The grain direction of all woodgrains will be horizontal (left to right) on the horizontal shelves
- Almond Horizontal (ADH), Portobello Horizontal (PBH), Portico Horizontal (PTH), Skyline Horizontal (SKH), Sonoma Horizontal (SMH), Designer White Linear Horizontal (491H), Cinder Linear Horizontal (492H) and Sable Horizontal (792H) laminates have horizontal grain on the wall insert and vertical shelves. All other woodgrains have vertical grain on the wall insert and vertical shelves
- Each horizontal shelf has a 50 lb. maximum limit

# EXHIBIT

## PRODUCT SPECIFICATIONS

- Each height of tack board, marker board, slat wall, and organizer shelf insert corresponds with a specific height of vertical storage in WaveWorks and Epic. See notation above models to see what model corresponds with appropriate height requirement
- Conference and training rooms commonly use 49" H inserts, but with Exhibit, you can use any of the 5 heights to achieve the customers needs
- As of April 20th, 2015, the inserts (Slat, Slat/Tack Combo, Insert Shelves, and TV Mount Inserts) will only be compatible with rails ordered on or after April 20th, 2015. If trying to use 1 of these inserts with an existing rail, please contact customer service for more information

## TO ORDER WOOD UNITS, SPECIFY:

1. Model Number
2. Finish

## TO ORDER LW UNITS, SPECIFY:

1. Model Number
2. Laminate Shelf Color
3. Finish Wall Color

## TO ORDER LAMINATE UNITS, SPECIFY:

1. Model Number
2. Laminate Shelf Color
3. Laminate Wall Color

## TO ORDER WL UNITS, SPECIFY:

1. Model Number
2. Wood Shelf Finish
3. Laminate Wall Color

## SAMPLE MODEL NUMBERS:

11N3649SH4W MH  
 11N3649SH4LW 462 CW  
 11N3649SH4L 405 478

- See pages 306-307 for all options available in Exhibit

MODEL NO./DESCRIPTION	LIST PRICE	DIMENSIONS					CARTONED WEIGHT	CUBIC FEET
		D	W	H	A	KW		
<b>ORGANIZER SHELF INSERTS (CONTINUED)</b>								
<b>COMPATIBLE WITH WAVEWORKS 80" HIGH WVN MODELS</b>								
<b>49"H ORGANIZER SHELF INSERTS (CONTINUED)</b>								
11N3649SH4W Wood	\$ 2025	10½	35⅞	48⅜	—	—	61 lbs.	4.6
11N3649SH4LW Laminate Shelves, Wood Wall	2025	10½	35⅞	48⅜	—	—	61 lbs.	4.6
11N3649SH4L Laminate	1397	10½	35⅞	48⅜	—	—	61 lbs.	4.6
11N3649SH4WL Wood Shelves, Laminate Wall	2025	10½	35⅞	48⅜	—	—	61 lbs.	4.6
<hr/>								
11N4249SH4W Wood	\$ 2029	10½	41⅞	48⅜	—	—	71 lbs.	5.2
11N4249SH4LW Laminate Shelves, Wood Wall	2029	10½	41⅞	48⅜	—	—	71 lbs.	5.2
11N4249SH4L Laminate	1399	10½	41⅞	48⅜	—	—	71 lbs.	5.2
11N4249SH4WL Wood Shelves, Laminate Wall	2029	10½	41⅞	48⅜	—	—	71 lbs.	5.2
<hr/>								
11N4849SH4W Wood	\$ 2252	10½	47⅞	48⅜	—	—	81 lbs.	5.9
11N4849SH4LW Laminate Shelves, Wood Wall	2252	10½	47⅞	48⅜	—	—	81 lbs.	5.9
11N4849SH4L Laminate	1553	10½	47⅞	48⅜	—	—	81 lbs.	5.9
11N4849SH4WL Wood Shelves, Laminate Wall	2252	10½	47⅞	48⅜	—	—	81 lbs.	5.9
<hr/>								
11N5449SH4W Wood	\$ 2479	10½	53⅞	48⅜	—	—	91 lbs.	6.6
11N5449SH4LW Laminate Shelves, Wood Wall	2479	10½	53⅞	48⅜	—	—	91 lbs.	6.6
11N5449SH4L Laminate	1709	10½	53⅞	48⅜	—	—	91 lbs.	6.6
11N5449SH4WL Wood Shelves, Laminate Wall	2479	10½	53⅞	48⅜	—	—	91 lbs.	6.6
<hr/>								
11N6049SH4W Wood	\$ 2727	10½	59⅞	48⅜	—	—	100 lbs.	7.2
11N6049SH4LW Laminate Shelves, Wood Wall	2727	10½	59⅞	48⅜	—	—	100 lbs.	7.2
11N6049SH4L Laminate	1880	10½	59⅞	48⅜	—	—	100 lbs.	7.2
11N6049SH4WL Wood Shelves, Laminate Wall	2727	10½	59⅞	48⅜	—	—	100 lbs.	7.2

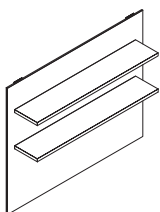
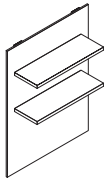

- Some assembly required
- "SH4" models have 2 shelves that align with the top shelves of the "SH1" and "SH2" shelves
- The grain direction of all woodgrains will be horizontal (left to right) on the horizontal shelves
- Almond Horizontal (ADH), Portobello Horizontal (PBH), Portico Horizontal (PTH), Skyline Horizontal (SKH), Sonoma Horizontal (SMH), Designer White Linear Horizontal (491H), Cinder Linear Horizontal (492H) and Sable Horizontal (792H) laminates have horizontal grain on the wall insert and vertical shelves. All other woodgrains have vertical grain on the wall insert and vertical shelves
- Each horizontal shelf has a 50 lb. maximum limit

**PRODUCT SPECIFICATIONS**

- Each height of tack board, marker board, slat wall, and organizer shelf insert corresponds with a specific height of vertical storage in WaveWorks and Epic. See notation above models to see what model corresponds with appropriate height requirement
- Conference and training rooms commonly use 49" H inserts, but with Exhibit, you can use any of the 5 heights to achieve the customers needs
- As of April 20th, 2015, the inserts (Slat, Slat/Tack Combo, Insert Shelves, and TV Mount Inserts) will only be compatible with rails ordered on or after April 20th, 2015. If trying to use 1 of these inserts with an existing rail, please contact customer service for more information

**TO ORDER WOOD UNITS, SPECIFY:**

1. Model Number
2. Finish

**TO ORDER LW UNITS, SPECIFY:**

1. Model Number
2. Laminate Shelf Color
3. Finish Wall Color

**TO ORDER LAMINATE UNITS, SPECIFY:**

1. Model Number
2. Laminate Shelf Color
3. Laminate Wall Color

**TO ORDER WL UNITS, SPECIFY:**

1. Model Number
2. Wood Shelf Finish
3. Laminate Wall Color

**SAMPLE MODEL NUMBERS:**

11N3649SH5W MH  
 11N3649SH5LW 462 CW  
 11N3649SH5L 405 478

- See pages 306-307 for all options available in Exhibit

MODEL NO./DESCRIPTION	LIST PRICE	DIMENSIONS					CARTONED WEIGHT	CUBIC FEET
		D	W	H	A	KW		
<b>ORGANIZER SHELF INSERTS (CONTINUED)</b>								
<b>COMPATIBLE WITH WAVEWORKS 80" HIGH WVN MODELS 49"H ORGANIZER SHELF INSERTS (CONTINUED)</b>								
11N3649SH5W Wood	\$ 2097	10½	35½	48½	—	—	69 lbs.	4.6
11N3649SH5LW Laminate Shelves, Wood Wall	2097	10½	35½	48½	—	—	69 lbs.	4.6
11N3649SH5L Laminate	1444	10½	35½	48½	—	—	69 lbs.	4.6
11N3649SH5WL Wood Shelves, Laminate Wall	2097	10½	35½	48½	—	—	69 lbs.	4.6
<hr/>								
11N4249SH5W Wood	\$ 2100	10½	41½	48½	—	—	81 lbs.	5.2
11N4249SH5LW Laminate Shelves, Wood Wall	2100	10½	41½	48½	—	—	81 lbs.	5.2
11N4249SH5L Laminate	1445	10½	41½	48½	—	—	81 lbs.	5.2
11N4249SH5WL Wood Shelves, Laminate Wall	2100	10½	41½	48½	—	—	81 lbs.	5.2
<hr/>								
11N4849SH5W Wood	\$ 2330	10½	47½	48½	—	—	93 lbs.	5.9
11N4849SH5LW Laminate Shelves, Wood Wall	2330	10½	47½	48½	—	—	93 lbs.	5.9
11N4849SH5L Laminate	1606	10½	47½	48½	—	—	93 lbs.	5.9
11N4849SH5WL Wood Shelves, Laminate Wall	2330	10½	47½	48½	—	—	93 lbs.	5.9
<hr/>								
11N5449SH5W Wood	\$ 2564	10½	53¾	48½	—	—	104 lbs.	6.6
11N5449SH5LW Laminate Shelves, Wood Wall	2564	10½	53¾	48½	—	—	104 lbs.	6.6
11N5449SH5L Laminate	1767	10½	53¾	48½	—	—	104 lbs.	6.6
11N5449SH5WL Wood Shelves, Laminate Wall	2564	10½	53¾	48½	—	—	104 lbs.	6.6
<hr/>								
11N6049SH5W Wood	\$ 2819	10½	59½	48½	—	—	116 lbs.	7.2
11N6049SH5LW Laminate Shelves, Wood Wall	2819	10½	59½	48½	—	—	116 lbs.	7.2
11N6049SH5L Laminate	1944	10½	59½	48½	—	—	116 lbs.	7.2
11N6049SH5WL Wood Shelves, Laminate Wall	2819	10½	59½	48½	—	—	116 lbs.	7.2

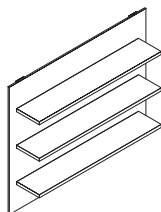
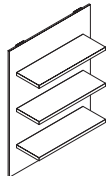

- Some assembly required
- "SH5" models have 3 shelves that align with the horizontal shelves of the "SH1" and "SH2" shelves
- The grain direction of all woodgrains will be horizontal (left to right) on the horizontal shelves
- Almond Horizontal (ADH), Portobello Horizontal (PBH), Portico Horizontal (PTH), Skyline Horizontal (SKH), Sonoma Horizontal (SMH), Designer White Linear Horizontal (491H), Cinder Linear Horizontal (492H) and Sable Horizontal (792H) laminates have horizontal grain on the wall insert and vertical shelves. All other woodgrains have vertical grain on the wall insert and vertical shelves
- Each horizontal shelf has a 50 lb. maximum limit

# EXHIBIT

## PRODUCT SPECIFICATIONS

- Each height of tack board, marker board, slat wall, and organizer shelf insert corresponds with a specific height of vertical storage in WaveWorks and Epic. See notation above models to see what model corresponds with appropriate height requirement
- Conference and training rooms commonly use 49" H inserts, but with Exhibit, you can use any of the 5 heights to achieve the customers needs
- As of April 20th, 2015, the inserts (Slat, Slat/Tack Combo, Insert Shelves, and TV Mount Inserts) will only be compatible with rails ordered on or after April 20th, 2015. If trying to use 1 of these inserts with an existing rail, please contact customer service for more information

## TO ORDER WOOD UNITS, SPECIFY:

1. Model Number
2. Shelf Height (SH6 models only)
3. Finish

## TO ORDER LW UNITS, SPECIFY:

1. Model Number
2. Shelf Height (SH6 models only)
3. Laminate Shelf Color
4. Finish Wall Color

## TO ORDER LAMINATE UNITS, SPECIFY:

1. Model Number
2. Shelf Height (SH6 models only)
3. Laminate Shelf Color
4. Laminate Wall Color

## TO ORDER WL UNITS, SPECIFY:

1. Model Number
2. Shelf Height (SH6 models only)
3. Wood Shelf Finish
4. Laminate Wall Color

## SAMPLE MODEL NUMBERS:

11N3649SH6W B MH  
 11N3649SH6LW B 462 CW  
 11N3649SH6L B 405 478

- See pages 306-307 for all options available in Exhibit

MODEL NO./DESCRIPTION	LIST PRICE	DIMENSIONS					CARTONED WEIGHT	CUBIC FEET
		D	W	H	A	KW		
<b>COMPATIBLE WITH WAVEWORKS 80" HIGH WVN MODELS</b>								
<b>49"H ORGANIZER SHELF INSERTS (CONTINUED)</b>								
11N3649SH6W	Wood	\$ 1978	10½	35⅞	48⅜	—	—	53 lbs. 4.6
11N3649SH6LW	Laminate Shelves, Wood Wall	1978	10½	35⅞	48⅜	—	—	53 lbs. 4.6
11N3649SH6L	Laminate	1362	10½	35⅞	48⅜	—	—	53 lbs. 4.6
11N3649SH6WL	Wood Shelves, Laminate Wall	1978	10½	35⅞	48⅜	—	—	53 lbs. 4.6
<hr/>								
11N4249SH6W	Wood	\$ 1981	10½	41⅞	48⅜	—	—	61 lbs. 5.2
11N4249SH6LW	Laminate Shelves, Wood Wall	1981	10½	41⅞	48⅜	—	—	61 lbs. 5.2
11N4249SH6L	Laminate	1367	10½	41⅞	48⅜	—	—	61 lbs. 5.2
11N4249SH6WL	Wood Shelves, Laminate Wall	1981	10½	41⅞	48⅜	—	—	61 lbs. 5.2
<hr/>								
11N4849SH6W	Wood	\$ 2200	10½	47⅞	48⅜	—	—	69 lbs. 5.9
11N4849SH6LW	Laminate Shelves, Wood Wall	2200	10½	47⅞	48⅜	—	—	69 lbs. 5.9
11N4849SH6L	Laminate	1517	10½	47⅞	48⅜	—	—	69 lbs. 5.9
11N4849SH6WL	Wood Shelves, Laminate Wall	2200	10½	47⅞	48⅜	—	—	69 lbs. 5.9
<hr/>								
11N5449SH6W	Wood	\$ 2423	10½	53⅞	48⅜	—	—	78 lbs. 6.6
11N5449SH6LW	Laminate Shelves, Wood Wall	2423	10½	53⅞	48⅜	—	—	78 lbs. 6.6
11N5449SH6L	Laminate	1669	10½	53⅞	48⅜	—	—	78 lbs. 6.6
11N5449SH6WL	Wood Shelves, Laminate Wall	2423	10½	53⅞	48⅜	—	—	78 lbs. 6.6
<hr/>								
11N6049SH6W	Wood	\$ 2662	10½	59⅞	48⅜	—	—	86 lbs. 7.2
11N6049SH6LW	Laminate Shelves, Wood Wall	2662	10½	59⅞	48⅜	—	—	86 lbs. 7.2
11N6049SH6L	Laminate	1837	10½	59⅞	48⅜	—	—	86 lbs. 7.2
11N6049SH6WL	Wood Shelves, Laminate Wall	2662	10½	59⅞	48⅜	—	—	86 lbs. 7.2

### ORGANIZER SHELF INSERTS (CONTINUED)

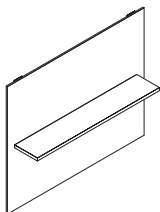
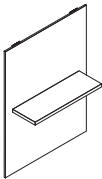

- Some assembly required
- "SH6" 48"/49" high models have 1 shelf that can be configured to align with the bottom of a 13", 18", 30" high overhead, or top shelf of the SH1/SH2 48"/49" inserts
- The grain direction of all woodgrains will be horizontal (left to right) on the horizontal shelves
- Almond Horizontal (ADH), Portobello Horizontal (PBH), Portico Horizontal (PTH), Skyline Horizontal (SKH), Sonoma Horizontal (SMH), Designer White Linear Horizontal (491H), Cinder Linear Horizontal (492H) and Sable Horizontal (792H) laminates have horizontal grain on the wall insert and vertical shelves. All other woodgrains have vertical grain on the wall insert and vertical shelves
- Each horizontal shelf has a 50 lb. maximum limit

**PRODUCT SPECIFICATIONS**

- Each height of tack board, marker board, slat wall, and organizer shelf insert corresponds with a specific height of vertical storage in WaveWorks and Epic. See notation above models to see what model corresponds with appropriate height requirement
- Conference and training rooms commonly use 49" H inserts, but with Exhibit, you can use any of the 5 heights to achieve the customers needs
- As of April 20th, 2015, the inserts (Slat, Slat/Tack Combo, Insert Shelves, and TV Mount Inserts) will only be compatible with rails ordered on or after April 20th, 2015. If trying to use 1 of these inserts with an existing rail, please contact customer service for more information

**TO ORDER WOOD UNITS, SPECIFY:**

1. Model Number
2. Finish

**TO ORDER LW UNITS, SPECIFY:**

1. Model Number
2. Laminate Shelf Color
3. Finish Wall Color

**TO ORDER LAMINATE UNITS, SPECIFY:**

1. Model Number
2. Laminate Shelf Color
3. Laminate Wall Color

**TO ORDER WL UNITS, SPECIFY:**

1. Model Number
2. Wood Shelf Finish
3. Laminate Wall Color

**SAMPLE MODEL NUMBERS:**

11N3649SH7W MH  
 11N3649SH7LW 462 CW  
 11N3649SH7L 405 478

- See pages 306-307 for all options available in Exhibit

MODEL NO./DESCRIPTION	LIST PRICE	DIMENSIONS					CARTONED WEIGHT	CUBIC FEET
		D	W	H	A	KW		
<b>ORGANIZER SHELF INSERTS (CONTINUED)</b>								
<b>COMPATIBLE WITH WAVEWORKS 80" HIGH WVN MODELS 49"H ORGANIZER SHELF INSERTS (CONTINUED)</b>								
11N3649SH7W Wood	\$ 2025	10½	35½	48½	—	—	61 lbs.	4.6
11N3649SH7LW Laminate Shelves, Wood Wall	2025	10½	35½	48½	—	—	61 lbs.	4.6
11N3649SH7L Laminate	1397	10½	35½	48½	—	—	61 lbs.	4.6
11N3649SH7WL Wood Shelves, Laminate Wall	2025	10½	35½	48½	—	—	61 lbs.	4.6
<hr/>								
11N4249SH7W Wood	\$ 2029	10½	41½	48½	—	—	71 lbs.	5.2
11N4249SH7LW Laminate Shelves, Wood Wall	2029	10½	41½	48½	—	—	71 lbs.	5.2
11N4249SH7L Laminate	1399	10½	41½	48½	—	—	71 lbs.	5.2
11N4249SH7WL Wood Shelves, Laminate Wall	2029	10½	41½	48½	—	—	71 lbs.	5.2
<hr/>								
11N4849SH7W Wood	\$ 2252	10½	47½	48½	—	—	81 lbs.	5.9
11N4849SH7LW Laminate Shelves, Wood Wall	2252	10½	47½	48½	—	—	81 lbs.	5.9
11N4849SH7L Laminate	1553	10½	47½	48½	—	—	81 lbs.	5.9
11N4849SH7WL Wood Shelves, Laminate Wall	2252	10½	47½	48½	—	—	81 lbs.	5.9
<hr/>								
11N5449SH7W Wood	\$ 2479	10½	53	48½	—	—	91 lbs.	6.6
11N5449SH7LW Laminate Shelves, Wood Wall	2479	10½	53	48½	—	—	91 lbs.	6.6
11N5449SH7L Laminate	1709	10½	53	48½	—	—	91 lbs.	6.6
11N5449SH7WL Wood Shelves, Laminate Wall	2479	10½	53	48½	—	—	91 lbs.	6.6
<hr/>								
11N6049SH7W Wood	\$ 2727	10½	59½	48½	—	—	100 lbs.	7.2
11N6049SH7LW Laminate Shelves, Wood Wall	2727	10½	59½	48½	—	—	100 lbs.	7.2
11N6049SH7L Laminate	1880	10½	59½	48½	—	—	100 lbs.	7.2
11N6049SH7WL Wood Shelves, Laminate Wall	2727	10½	59½	48½	—	—	100 lbs.	7.2

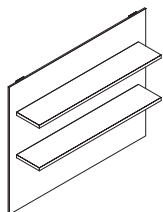
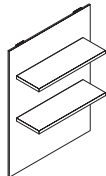

- Some assembly required
- "SH7" models have 2 shelves; the bottom shelf aligns with the bottom of a 30" overhead
- The grain direction of all woodgrains will be horizontal (left to right) on the horizontal shelves
- Almond Horizontal (ADH), Portobello Horizontal (PBH), Portico Horizontal (PTH), Skyline Horizontal (SKH), Sonoma Horizontal (SMH), Designer White Linear Horizontal (491H), Cinder Linear Horizontal (492H) and Sable Horizontal (792H) laminates have horizontal grain on the wall insert and vertical shelves. All other woodgrains have vertical grain on the wall insert and vertical shelves
- Each horizontal shelf has a 50 lb. maximum limit

# EXHIBIT

## TO ORDER, SPECIFY:

1. Model Number
2. Laminate Color

## SAMPLE MODEL NUMBER:

11N3634WINL 492  
NAC12505WGV1

- See pages 306-307 for all options available in Exhibit

MODEL NO./DESCRIPTION	LIST PRICE	DIMENSIONS					CARTONED WEIGHT	CUBIC FEET
		D	W	H	A	KW		
<b>LAMINATE INSERT</b>								
11N3634WINL	\$ 364	10½	35 <sup>5</sup> / <sub>16</sub>	34 <sup>1</sup> / <sub>8</sub>	—	—	41 lbs.	3.3
11N3636WINL	395	10½	35 <sup>5</sup> / <sub>16</sub>	36 <sup>3</sup> / <sub>16</sub>	—	—	43 lbs.	3.5
11N3637WINL	395	10½	35 <sup>5</sup> / <sub>16</sub>	37	—	—	43 lbs.	3.6
11N3648WINL	463	10½	35 <sup>5</sup> / <sub>16</sub>	48½	—	—	53 lbs.	4.5
11N3649WINL	463	10½	35 <sup>5</sup> / <sub>16</sub>	48 <sup>13</sup> / <sub>16</sub>	—	—	53 lbs.	4.6

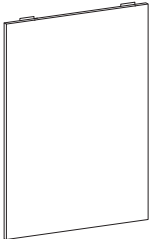

- Can be used to hang additional PPE equipment (ie. Glove holders and sanitizer dispensers). Limit of 10 lbs hung on the back

## SINGLE WIRE GLOVE BOX

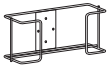

NAC1205WGV1	Steel	\$ 88	3 <sup>3</sup> / <sub>16</sub>	11 <sup>1</sup> / <sub>16</sub>	4 <sup>3</sup> / <sub>8</sub>	—	—	1 lbs.	1.38
-------------	-------	-------	--------------------------------	---------------------------------	-------------------------------	---	---	--------	------

- Steel wire Glove box is Chrome in color
- Includes pre-drilled mounting holes and hardware
- Holds 1 std size box of gloves

## DOUBLE WIRE GLOVE BOX



NAC1210WGV2	Steel	\$ 120	3 <sup>3</sup> / <sub>16</sub>	11 <sup>1</sup> / <sub>16</sub>	9½	—	—	1 lbs.	2.7
-------------	-------	--------	--------------------------------	---------------------------------	----	---	---	--------	-----

- Steel wire Glove box is Chrome in color
- Includes pre-drilled mounting holes and hardware
- Holds 2 std size boxes of gloves

## QUAD WIRE GLOVE BOX

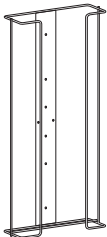

NAC1219WGV4	Steel	\$ 172	3 <sup>3</sup> / <sub>16</sub>	11 <sup>1</sup> / <sub>16</sub>	19	—	—	1 lbs.	5.2
-------------	-------	--------	--------------------------------	---------------------------------	----	---	---	--------	-----

- Steel wire Glove box is Chrome in color
- Includes pre-drilled mounting holes and hardware
- Holds 4 std size boxes of gloves

## AUTOMATIC HAND SANITIZER DISPENSER

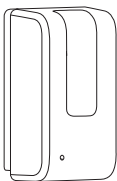

NAC0407USD1		\$ 598	4¼	6	11	—	—	2.2 lbs.	8.1
-------------	--	--------	----	---	----	---	---	----------	-----

- Dispenser accepts most bulk liquid soaps and sanitizers up to 12mL capacity, inside a solid case of durable ABS plastic
- 4 C Batteries sold separately. External On-Off switch
- Tamper resistant lock system with key for convenient access for assigned personnel
- Motion Dispenser: Dispenses within a sense detection of 3"-5"
- 2.2 lbs Empty (without fluid)

**PRODUCT SPECIFICATIONS**

- Each height of TV mount insert corresponds with a specific height of vertical storage in WaveWorks and Epic. See notation above models to see what model corresponds with appropriate height requirement
- Conference and training rooms commonly use 49" H inserts, but with Exhibit, you can use any of the 5 heights to achieve the customers needs
- Fabric Inserts are not tackable
- When TV mount inserts are used at the end of the run, specify Full End Trims for finish detail; see page 352
- As of April 20th, 2015, the inserts (Slat, Slat/Tack Combo, Insert Shelves, and TV Mount Inserts) will only be compatible with rails ordered on or after April 20th, 2015. If trying to use 1 of these inserts with an existing rail, please contact customer service for more information

**TO ORDER, SPECIFY:**

1. Model Number
2. TV Mount (60W only)
3. Finish/Laminate Color (Veneer/Laminate insert only)
4. Fabric Grade (Fabric insert only)
5. Fabric Color (Fabric insert only)

**SAMPLE MODEL NUMBERS:**

11N3634TVW B 25413  
 11N6034TVL TS B 25413

- See pages 306-307 for all options available in Exhibit

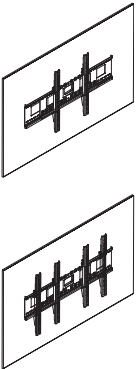
	MODEL NO./DESCRIPTION	LIST PRICE	DIMENSIONS					CARTONED CUBIC		
			D	W	H	A	KW	WEIGHT	FEET	
<b>TV MOUNT EXHIBIT INSERTS</b>										
<b>34"H TV MOUNT EXHIBIT INSERTS</b>										
 <p>(only 60" models)</p>	11N3634TVW	Wood	\$ 2068	½	35 <sup>1</sup> / <sub>16</sub>	34 <sup>1</sup> / <sub>8</sub>	—	—	47 lbs.	3.1
	11N3634TVL	Laminate	1481	½	35 <sup>1</sup> / <sub>16</sub>	34 <sup>1</sup> / <sub>8</sub>	—	—	47 lbs.	3.1
	11N4234TVW	Wood	\$ 2070	½	41 <sup>1</sup> / <sub>16</sub>	34 <sup>1</sup> / <sub>8</sub>	—	—	53 lbs.	3.3
	11N4234TVL	Laminate	1482	½	41 <sup>1</sup> / <sub>16</sub>	34 <sup>1</sup> / <sub>8</sub>	—	—	53 lbs.	3.3
	11N4834TVW	Wood	\$ 2278	½	47 <sup>1</sup> / <sub>16</sub>	34 <sup>1</sup> / <sub>8</sub>	—	—	58 lbs.	3.5
	11N4834TVL	Laminate	1627	½	47 <sup>1</sup> / <sub>16</sub>	34 <sup>1</sup> / <sub>8</sub>	—	—	58 lbs.	3.5
	11N5434TVW	Wood	\$ 2488	½	53 <sup>3</sup> / <sub>16</sub>	34 <sup>1</sup> / <sub>8</sub>	—	—	64 lbs.	3.5
	11N5434TVL	Laminate	1773	½	53 <sup>3</sup> / <sub>16</sub>	34 <sup>1</sup> / <sub>8</sub>	—	—	64 lbs.	3.5
	11N6034TVW	Wood	\$ 2720	½	59 <sup>1</sup> / <sub>16</sub>	34 <sup>1</sup> / <sub>8</sub>	—	—	71 lbs.	3.9
	11N6034TVL	Laminate	1932	½	59 <sup>1</sup> / <sub>16</sub>	34 <sup>1</sup> / <sub>8</sub>	—	—	71 lbs.	3.9
	<b>COMPATIBLE WITH WAVEWORKS 68" HIGH WW AND EPIC 68" HIGH MODELS</b>									
	<b>36"H TV MOUNT EXHIBIT INSERTS</b>									
	11N3636TVW	Wood	\$ 2092	½	35 <sup>1</sup> / <sub>16</sub>	36 <sup>3</sup> / <sub>16</sub>	—	—	51 lbs.	3.4
	11N3636TVL	Laminate	1499	½	35 <sup>1</sup> / <sub>16</sub>	36 <sup>3</sup> / <sub>16</sub>	—	—	51 lbs.	3.4
	11N4236TVW	Wood	\$ 2098	½	41 <sup>1</sup> / <sub>16</sub>	36 <sup>3</sup> / <sub>16</sub>	—	—	57 lbs.	3.6
	11N4236TVL	Laminate	1502	½	41 <sup>1</sup> / <sub>16</sub>	36 <sup>3</sup> / <sub>16</sub>	—	—	57 lbs.	3.6
	11N4836TVW	Wood	\$ 2309	½	47 <sup>1</sup> / <sub>16</sub>	36 <sup>3</sup> / <sub>16</sub>	—	—	62 lbs.	3.9
	11N4836TVL	Laminate	1648	½	47 <sup>1</sup> / <sub>16</sub>	36 <sup>3</sup> / <sub>16</sub>	—	—	62 lbs.	3.9
	11N5436TVW	Wood	\$ 2521	½	53 <sup>3</sup> / <sub>16</sub>	36 <sup>3</sup> / <sub>16</sub>	—	—	68 lbs.	4.1
	11N5436TVL	Laminate	1794	½	53 <sup>3</sup> / <sub>16</sub>	36 <sup>3</sup> / <sub>16</sub>	—	—	68 lbs.	4.1
	11N6036TVW	Wood	\$ 2756	½	59 <sup>1</sup> / <sub>16</sub>	36 <sup>3</sup> / <sub>16</sub>	—	—	74 lbs.	4.3
	11N6036TVL	Laminate	1957	½	59 <sup>1</sup> / <sub>16</sub>	36 <sup>3</sup> / <sub>16</sub>	—	—	74 lbs.	4.3

- TV mount included; some assembly required; VESA mounting compliant
- Maximum TV weight is 120 lbs.
- Optional single or dual TV mount on 60" inserts

# EXHIBIT

## PRODUCT SPECIFICATIONS

- Each height of TV mount insert corresponds with a specific height of vertical storage in WaveWorks and Epic. See notation above models to see what model corresponds with appropriate height requirement
- Conference and training rooms commonly use 49" H inserts, but with Exhibit, you can use any of the 5 heights to achieve the customers needs
- Fabric Inserts are not tackable
- When TV mount inserts are used at the end of the run, specify Full End Trims for finish detail; see page 352
- As of April 20th, 2015, the inserts (Slat, Slat/Tack Combo, Insert Shelves, and TV Mount Inserts) will only be compatible with rails ordered on or after April 20th, 2015. If trying to use 1 of these inserts with an existing rail, please contact customer service for more information

## TO ORDER, SPECIFY:

1. Model Number
2. TV Mount (60W only)
3. Finish/Laminate Color

## SAMPLE MODEL NUMBERS:

11N3637TVW MC  
11N3637TVL 462

- See pages 306-307 for all options available in Exhibit

MODEL NO./DESCRIPTION	LIST PRICE	DIMENSIONS					CARTONED WEIGHT	CUBIC FEET
		D	W	H	A	KW		
<b>TV MOUNT EXHIBIT INSERTS (CONTINUED)</b>								
<b>COMPATIBLE WITH WAVEWORKS 69" HIGH WVN MODELS</b>								
<b>37"H TV MOUNT EXHIBIT INSERTS</b>								
11N3637TVW Wood	\$ 2092	½	35 <sup>5</sup> / <sub>16</sub>	37	—	—	51 lbs.	3.4
11N3637TVL Laminate	1499	½	35 <sup>5</sup> / <sub>16</sub>	37	—	—	51 lbs.	3.4
11N4237TVW Wood	\$ 2098	½	41 <sup>1</sup> / <sub>16</sub>	37	—	—	57 lbs.	3.6
11N4237TVL Laminate	1502	½	41 <sup>1</sup> / <sub>16</sub>	37	—	—	57 lbs.	3.6
11N4837TVW Wood	\$ 2309	½	47 <sup>9</sup> / <sub>16</sub>	37	—	—	62 lbs.	3.9
11N4837TVL Laminate	1648	½	47 <sup>9</sup> / <sub>16</sub>	37	—	—	62 lbs.	3.9
11N5437TVW Wood	\$ 2521	½	53 <sup>7</sup> / <sub>16</sub>	37	—	—	68 lbs.	4.1
11N5437TVL Laminate	1794	½	53 <sup>7</sup> / <sub>16</sub>	37	—	—	68 lbs.	4.1
11N6037TVW Wood	\$ 2756	½	59 <sup>1</sup> / <sub>16</sub>	37	—	—	74 lbs.	4.3
11N6037TVL Laminate	1957	½	59 <sup>1</sup> / <sub>16</sub>	37	—	—	74 lbs.	4.3
<b>COMPATIBLE WITH WAVEWORKS 79" HIGH WW MODELS</b>								
<b>48"H TV MOUNT EXHIBIT INSERTS</b>								
11N3648TVW Wood	\$ 2439	½	35 <sup>5</sup> / <sub>16</sub>	48 <sup>3</sup> / <sub>8</sub>	—	—	69 lbs.	5.0
11N3648TVL Laminate	1738	½	35 <sup>5</sup> / <sub>16</sub>	48 <sup>3</sup> / <sub>8</sub>	—	—	69 lbs.	5.0
11N4248TVW Wood	\$ 2442	½	41 <sup>1</sup> / <sub>16</sub>	48 <sup>3</sup> / <sub>8</sub>	—	—	77 lbs.	5.2
11N4248TVL Laminate	1740	½	41 <sup>1</sup> / <sub>16</sub>	48 <sup>3</sup> / <sub>8</sub>	—	—	77 lbs.	5.2
11N4848TVW Wood	\$ 2694	½	47 <sup>9</sup> / <sub>16</sub>	48 <sup>3</sup> / <sub>8</sub>	—	—	85 lbs.	5.5
11N4848TVL Laminate	1913	½	47 <sup>9</sup> / <sub>16</sub>	48 <sup>3</sup> / <sub>8</sub>	—	—	85 lbs.	5.5
11N5448TVW Wood	\$ 2945	½	53 <sup>7</sup> / <sub>16</sub>	48 <sup>3</sup> / <sub>8</sub>	—	—	93 lbs.	5.8
11N5448TVL Laminate	2085	½	53 <sup>7</sup> / <sub>16</sub>	48 <sup>3</sup> / <sub>8</sub>	—	—	93 lbs.	5.8
11N6048TVW Wood	\$ 3221	½	59 <sup>1</sup> / <sub>16</sub>	48 <sup>3</sup> / <sub>8</sub>	—	—	101 lbs.	6.1
11N6048TVL Laminate	2276	½	59 <sup>1</sup> / <sub>16</sub>	48 <sup>3</sup> / <sub>8</sub>	—	—	101 lbs.	6.1

- TV mount included; some assembly required; VESA mounting compliant
- Maximum TV weight is 120 lbs.
- Optional single or dual TV mount on 60" inserts

### TV MOUNT EXHIBIT INSERTS (CONTINUED)

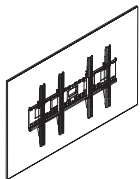
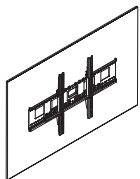

(only 60" models)



**PRODUCT SPECIFICATIONS**

- Each height of TV mount insert corresponds with a specific height of vertical storage in WaveWorks and Epic. See notation above models to see what model corresponds with appropriate height requirement
- Conference and training rooms commonly use 49" H inserts, but with Exhibit, you can use any of the 5 heights to achieve the customers needs
- Fabric Inserts are not tackable
- When TV mount inserts are used at the end of the run, specify Full End Trims for finish detail; see page 352
- As of April 20th, 2015, the inserts (Slat, Slat/Tack Combo, Insert Shelves, and TV Mount Inserts) will only be compatible with rails ordered on or after April 20th, 2015. If trying to use 1 of these inserts with an existing rail, please contact customer service for more information

**TO ORDER, SPECIFY:**

1. Model Number
2. TV Mount (60W only)
3. Finish/Laminate Color

**SAMPLE MODEL NUMBERS:**

11N3649TVW MC  
11N3649TVL 462

- See pages 306-307 for all options available in Exhibit

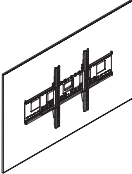
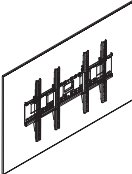
	MODEL NO./DESCRIPTION	LIST PRICE	DIMENSIONS					CARTONED WEIGHT	CUBIC FEET	
			D	W	H	A	KW			
<b>TV MOUNT EXHIBIT INSERTS (CONTINUED)</b>	<b>COMPATIBLE WITH WAVEWORKS 80" HIGH WVN MODELS</b>									
	<b>49"H TV MOUNT EXHIBIT INSERTS</b>									
	11N3649TVW	Wood	\$ 2439	½	35 <sup>1</sup> / <sub>16</sub>	48 <sup>1</sup> / <sub>16</sub>	—	—	69 lbs.	5.0
	11N3649TVL	Laminate	1738	½	35 <sup>1</sup> / <sub>16</sub>	48 <sup>1</sup> / <sub>16</sub>	—	—	69 lbs.	5.0
	11N4249TVW	Wood	\$ 2442	½	41 <sup>1</sup> / <sub>16</sub>	48 <sup>1</sup> / <sub>16</sub>	—	—	77 lbs.	5.2
	11N4249TVL	Laminate	1740	½	41 <sup>1</sup> / <sub>16</sub>	48 <sup>1</sup> / <sub>16</sub>	—	—	77 lbs.	5.2
(only 60" models)	11N4849TVW	Wood	\$ 2694	½	47 <sup>1</sup> / <sub>16</sub>	48 <sup>1</sup> / <sub>16</sub>	—	—	85 lbs.	5.5
	11N4849TVL	Laminate	1913	½	47 <sup>1</sup> / <sub>16</sub>	48 <sup>1</sup> / <sub>16</sub>	—	—	85 lbs.	5.5
	11N5449TVW	Wood	\$ 2945	½	53 <sup>7</sup> / <sub>16</sub>	48 <sup>1</sup> / <sub>16</sub>	—	—	93 lbs.	5.8
	11N5449TVL	Laminate	2085	½	53 <sup>7</sup> / <sub>16</sub>	48 <sup>1</sup> / <sub>16</sub>	—	—	93 lbs.	5.8
	11N6049TVW	Wood	\$ 3221	½	59 <sup>1</sup> / <sub>16</sub>	48 <sup>1</sup> / <sub>16</sub>	—	—	101 lbs.	6.1
	11N6049TVL	Laminate	2276	½	59 <sup>1</sup> / <sub>16</sub>	48 <sup>1</sup> / <sub>16</sub>	—	—	101 lbs.	6.1
<ul style="list-style-type: none"> <li>• TV mount included; some assembly required; VESA mounting compliant</li> <li>• Maximum TV weight is 120 lbs.</li> <li>• Optional single or dual TV mount on 60" inserts</li> </ul>										
<b>EXHIBIT TV MOUNT VERTICAL WIRE MANAGER</b>	11N0615WMVW	Wood	\$ 358	1½	5 <sup>3</sup> / <sub>16</sub>	15 <sup>7</sup> / <sub>16</sub>	—	—	8 lbs.	0.6
	11N0615WMVL	Laminate	238	1½	5 <sup>3</sup> / <sub>16</sub>	15 <sup>7</sup> / <sub>16</sub>	—	—	8 lbs.	0.6
<ul style="list-style-type: none"> <li>• Attaches to the Exhibit TV mount inserts; used to conceal power in-feed and data cables</li> <li>• When using Exhibit TV mount inserts and vertical wire manager with a Mio Exhibit mount worksurface, the worksurface needs to be configured with a notch for the worksurface wire manager</li> </ul>										

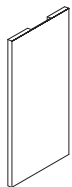

# EXHIBIT

## PRODUCT SPECIFICATIONS

- Each height of trim channel corresponds with a specific height of vertical storage in WaveWorks and Epic. See notation above models to see what model corresponds with appropriate height requirement

## TO ORDER, SPECIFY:

1. Model Number
2. Paint Color
3. Fabric Grade
4. Fabric Color

## SAMPLE MODEL NUMBER:

11N37ETP 501

- See pages 306-307 for all options available in Exhibit

MODEL NO./DESCRIPTION	LIST PRICE	DIMENSIONS					CARTONED WEIGHT	CUBIC FEET
		D	W	H	A	KW		
<b>FULL END TRIM</b>								
<b>FOR USE WITH 34"H INSERTS</b>								
11N37ETP Powder Coated	\$ 79	1 <sup>1</sup> / <sub>6</sub>	1 <sup>1</sup> / <sub>2</sub>	37 <sup>1</sup> / <sub>6</sub>	—	—	1 lbs.	0.2
<b>COMPATIBLE WITH WAVEWORKS 68" HIGH WW AND EPIC 68" HIGH MODELS</b>								
<b>FOR USE WITH 36"H INSERTS</b>								
11N39ETP Powder Coated	\$ 83	1 <sup>1</sup> / <sub>6</sub>	1 <sup>1</sup> / <sub>2</sub>	39 <sup>1</sup> / <sub>6</sub>	—	—	1 lbs.	0.3
<b>COMPATIBLE WITH WAVEWORKS 69" HIGH WW MODELS</b>								
<b>FOR USE WITH 37"H INSERTS</b>								
11N40ETP Powder Coated	\$ 83	1 <sup>1</sup> / <sub>6</sub>	1 <sup>1</sup> / <sub>2</sub>	39 <sup>1</sup> / <sub>6</sub>	—	—	1 lbs.	0.3
<b>COMPATIBLE WITH WAVEWORKS 79" HIGH WW MODELS</b>								
<b>FOR USE WITH 48"H INSERTS</b>								
11N51ETP Powder Coated	\$ 94	1 <sup>1</sup> / <sub>6</sub>	1 <sup>1</sup> / <sub>2</sub>	51 <sup>1</sup> / <sub>4</sub>	—	—	1 lbs.	0.3
<b>COMPATIBLE WITH WAVEWORKS 80" HIGH WW MODELS</b>								
<b>FOR USE WITH 49"H INSERTS</b>								
11N52ETP Powder Coated	\$ 94	1 <sup>1</sup> / <sub>6</sub>	1 <sup>1</sup> / <sub>2</sub>	51 <sup>1</sup> / <sub>6</sub>	—	—	1 lbs.	0.4

- Specify Full End Trim for finish detail when end of Exhibit rail and tack/marker board insert are exposed
- Full End Trim is attached to top wall rail and extends down to and attaches to bottom rail

## VERTICAL CABLE MANAGER

MODEL NO./DESCRIPTION	LIST PRICE	GRADE A	GRADE B/COM	DIMENSIONS					CARTONED WEIGHT	CUBIC FEET																																						
				D	W	H	A	KW																																								
11N20WMV Black Plastic	\$ 30			1	1	20	—	—	1 lbs.	0.5																																						
11N20WMVFA Fabric, Railroad	\$ 42	\$ 50		1	1	20	—	—	1 lbs.	0.5																																						
<ul style="list-style-type: none"> <li>• For use with 34", 36" or 37" inserts when a single height overhead cabinet is attached; or 48" and 49" inserts when a double height overhead cabinet is attached</li> <li>• Fabric will be railroaded</li> </ul>																																																
<table border="1"> <thead> <tr> <th rowspan="2">MODEL NO./DESCRIPTION</th> <th rowspan="2">LIST PRICE</th> <th rowspan="2">GRADE A</th> <th rowspan="2">GRADE B/COM</th> <th colspan="5">DIMENSIONS</th> <th rowspan="2">CARTONED WEIGHT</th> <th rowspan="2">CUBIC FEET</th> </tr> <tr> <th>D</th> <th>W</th> <th>H</th> <th>A</th> <th>KW</th> </tr> </thead> <tbody> <tr> <td>11N31WMV Black Plastic</td> <td>\$ 40</td> <td></td> <td></td> <td>1</td> <td>1</td> <td>31</td> <td>—</td> <td>—</td> <td>2 lbs.</td> <td>0.6</td> </tr> <tr> <td>11N31WMVFA Fabric, Railroad</td> <td>\$ 51</td> <td>\$ 59</td> <td></td> <td>1</td> <td>1</td> <td>31</td> <td>—</td> <td>—</td> <td>2 lbs.</td> <td>0.6</td> </tr> </tbody> </table>											MODEL NO./DESCRIPTION	LIST PRICE	GRADE A	GRADE B/COM	DIMENSIONS					CARTONED WEIGHT	CUBIC FEET	D	W	H	A	KW	11N31WMV Black Plastic	\$ 40			1	1	31	—	—	2 lbs.	0.6	11N31WMVFA Fabric, Railroad	\$ 51	\$ 59		1	1	31	—	—	2 lbs.	0.6
MODEL NO./DESCRIPTION	LIST PRICE	GRADE A	GRADE B/COM	DIMENSIONS					CARTONED WEIGHT	CUBIC FEET																																						
				D	W	H	A	KW																																								
11N31WMV Black Plastic	\$ 40			1	1	31	—	—	2 lbs.	0.6																																						
11N31WMVFA Fabric, Railroad	\$ 51	\$ 59		1	1	31	—	—	2 lbs.	0.6																																						
<ul style="list-style-type: none"> <li>• For use with 48" or 49" inserts when a single height cabinet is attached</li> <li>• Fabric will be railroaded</li> </ul>																																																

**PRODUCT SPECIFICATIONS**

- Each height of trim channel corresponds with a specific height of vertical storage in WaveWorks and Epic. See notation above models to see what model corresponds with appropriate height requirement

**TO ORDER, SPECIFY:**

1. Model Number
2. Paint Color
3. Fabric Grade
4. Fabric Color

**SAMPLE MODEL NUMBERS:**

11N34TCF B 25413  
11N01ETP 501

- See pages 306-307 for all options available in Exhibit

	MODEL NO./DESCRIPTION	LIST PRICE	DIMENSIONS					CARTONED WEIGHT	CUBIC FEET
			D	W	H	A	KW		

**SINGLE END CAP**

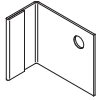

11N01ETP		\$ 36	½	1¾	1¾	—	—	1 lbs.	0.3
----------	--	-------	---	----	----	---	---	--------	-----

- Specify end caps for finish detail when end of Exhibit rail is exposed, does not work with faceplate on wall rail
- End caps are sold individually
- End caps available in Concrete (423), Cinder (462), Iron (463), Platinum Metallic (501) or Satin Nickel Metallic (503)
- Exhibit end caps can also be used behind overheads or when used with a worksurface

**FABRIC WRAPPED TRIM CHANNELS**



34"H TRIM CHANNELS		GRADE A	GRADE B/COM							
11N34TCFA	Fabric, Railroad	\$ 49	\$ 57	½	¾	34¾	—	—	1 lbs.	0.3

**COMPATIBLE WITH WAVEWORKS 68" HIGH WW AND EPIC 68" HIGH MODELS  
36"H TRIM CHANNELS**

11N36TCFA	Fabric, Railroad	\$ 50	\$ 58	½	¾	36¾	—	—	1 lbs.	0.3
-----------	------------------	-------	-------	---	---	-----	---	---	--------	-----

**COMPATIBLE WITH WAVEWORKS 69" HIGH WW MODELS  
37"H TRIM CHANNELS**

11N37TCFA	Fabric, Railroad	\$ 50	\$ 58	½	¾	37	—	—	1 lbs.	0.3
-----------	------------------	-------	-------	---	---	----	---	---	--------	-----

**COMPATIBLE WITH WAVEWORKS 79" HIGH WW MODELS  
48"H TRIM CHANNELS**

11N48TCFA	Fabric, Railroad	\$ 56	\$ 64	½	¾	48¾	—	—	1 lbs.	0.3
-----------	------------------	-------	-------	---	---	-----	---	---	--------	-----

**COMPATIBLE WITH WAVEWORKS 80" HIGH WW MODELS  
49"H TRIM CHANNELS**

11N49TCFA	Fabric, Railroad	\$ 56	\$ 64	½	¾	49¾	—	—	1 lbs.	0.3
-----------	------------------	-------	-------	---	---	-----	---	---	--------	-----

- 2 trim channels are included with every marker/tack board or slat wall insert, if marker board or tack board insert is cut to create new board, additional trim channels must be ordered
- Fabric will be railroaded

# EXHIBIT

## PRODUCT SPECIFICATIONS

- Each height of trim channel corresponds with a specific height of vertical storage in WaveWorks and Epic. See notation above models to see what model corresponds with appropriate height requirement

## TO ORDER, SPECIFY:

1. Model Number
2. Paint Color
3. Wood/Laminate Finish

## SAMPLE MODEL NUMBERS:

11N34TCP 462  
11NCPFSL MC

- See pages 306-307 for all options available in Exhibit

MODEL NO./DESCRIPTION	LIST PRICE	DIMENSIONS					CARTONED WEIGHT	CUBIC FEET
		D	W	H	A	KW		
<b>PAINTED TRIM CHANNELS</b>								
<b>34"H TRIM CHANNELS</b>								
11N34TCP Powder Coated	\$ 40	½	¾	34½	—	—	1 lbs.	0.3
<b>COMPATIBLE WITH WAVEWORKS 68" HIGH WW AND EPIC 68" HIGH MODELS</b>								
<b>36"H TRIM CHANNELS</b>								
11N36TCP Powder Coated	\$ 44	½	¾	36½	—	—	1 lbs.	0.3
<b>COMPATIBLE WITH WAVEWORKS 69" HIGH WW MODELS</b>								
<b>37"H TRIM CHANNELS</b>								
11N37TCP Powder Coated	\$ 44	½	¾	37	—	—	1 lbs.	0.3
<b>COMPATIBLE WITH WAVEWORKS 79" HIGH WW MODELS</b>								
<b>48"H TRIM CHANNELS</b>								
11N48TCP Powder Coated	\$ 51	½	¾	48½	—	—	1 lbs.	0.3
<b>COMPATIBLE WITH WAVEWORKS 80" HIGH WW MODELS</b>								
<b>49"H TRIM CHANNELS</b>								
11N49TCP Powder Coated	\$ 51	½	¾	48½	—	—	1 lbs.	0.3

- Available in White (401), Concrete (423), Cinder (462), Iron (463), Platinum Metallic (501) or Satin Nickel Metallic (503)
- 2 trim channels are included with every marker/tack board or slat wall insert, if marker board or tack board insert is cut to create new board, additional trim channels must be ordered

## WORKSURFACE MOUNTING BRACKET

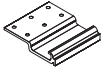

11NBRS Single Bracket	\$ 15	2	3	½	—	—	1 lbs.	0.3
-----------------------	-------	---	---	---	---	---	--------	-----

- For use when attaching a WaveWorks or Epic work surface to Exhibit wall rail
- Standard in anodized aluminum
- Specify model number only

Reference this chart for work surface bracket requirements

Work surface Width/Depth	Number of Brackets per edge
Less than or equal to 48"	2
Less than or equal to 72"	3
Greater than 72"	4

## FILLER STRIP KIT EXHIBIT MOUNT

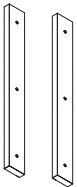

11NCPFSW Wood	\$ 53	1	3	27¼	—	—	3 lbs.	1.0
11NCPFSL Laminate	28	1	3	27¼	—	—	3 lbs.	1.0

- For use with Exhibit mounted overheads when an insert is not used behind the overhead
- Must be field scribed for 18" and 13" high overhead models
- Specify solid/woodgrain/Gallery laminate or wood finish

**PRODUCT SPECIFICATIONS**

• For use with Exhibit and Epicenter slat wall inserts

**TO ORDER, SPECIFY:**

1. Model Number
2. Paint Color

**SAMPLE MODEL NUMBER:**

NAC0924SHM 462

• See pages 306-307 for all options available in Exhibit

**METAL  
WORK TOOLS**

	MODEL NO./DESCRIPTION	LIST PRICE	DIMENSIONS					CARTONED WEIGHT	CUBIC FEET
			D	W	H	A	KW		
 <p><b>SHELF</b></p>	NAC0924SHM Powder Coated	\$ 108	9 $\frac{1}{2}$	24	2 $\frac{1}{4}$	–	–	5 lbs.	0.9
	NAC0930SHM Powder Coated	120	9 $\frac{1}{2}$	30	2 $\frac{1}{4}$	–	–	6 lbs.	1.1
	NAC0936SHM Powder Coated	133	9 $\frac{1}{2}$	36	2 $\frac{1}{4}$	–	–	7 lbs.	1.2
	NAC0942SHM Powder Coated	150	9 $\frac{1}{2}$	42	2 $\frac{1}{4}$	–	–	8 lbs.	1.3
	NAC0948SHM Powder Coated	162	9 $\frac{1}{2}$	48	2 $\frac{1}{4}$	–	–	9 lbs.	1.4

**SINGLE SIDE TRAY**

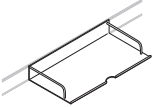
	NAC1217SPTM Single Tray	\$ 96	11 $\frac{1}{2}$	17	2 $\frac{1}{2}$	–	–	5 lbs.	0.7
---	-------------------------	-------	------------------	----	-----------------	---	---	--------	-----

**DOUBLE SIDE TRAY**

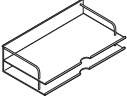
	NAC1217DPTM Double Tray	\$ 133	1 $\frac{1}{2}$	17	5	–	–	9 lbs.	1.0
---	-------------------------	--------	-----------------	----	---	---	---	--------	-----

**POCKET ORGANIZER**

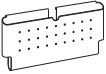
	NAC16POM Single Pocket	\$ 82	1 $\frac{1}{2}$	15 $\frac{1}{2}$	7 $\frac{1}{4}$	–	–	4 lbs.	1.1
---	------------------------	-------	-----------------	------------------	-----------------	---	---	--------	-----

**SLANT SORTER**

	NAC1212SSM Polished Aluminum Dividers	\$ 96	11 $\frac{3}{4}$	12	7 $\frac{1}{4}$	–	–	4 lbs.	1.1
---	---------------------------------------	-------	------------------	----	-----------------	---	---	--------	-----

• Not recommended for use under Epicenter mounted overhead storage cabinets

**MARKER HOLDER**

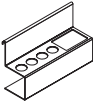
	NACMRHM	\$ 93	2 $\frac{1}{16}$	6 $\frac{1}{16}$	4	–	–	1 lbs.	0.1
---	---------	-------	------------------	------------------	---	---	---	--------	-----

**BINDER SHELF**

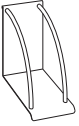
	NAC0905SHBM	\$ 60	9 $\frac{1}{2}$	5	8 $\frac{3}{8}$	–	–	3 lbs.	0.5
---	-------------	-------	-----------------	---	-----------------	---	---	--------	-----

• Not recommended for use under Epicenter mounted overhead storage cabinets

# EXHIBIT

## PRODUCT SPECIFICATIONS

- For use with Exhibit and Epicenter slat wall inserts
- Pencil Tray (NAC0510PTB) is only available in black and may not be an exact match

## TO ORDER, SPECIFY:

1. Model Number

## SAMPLE MODEL NUMBER:

NAC0510PTB

- See pages 306-307 for all options available in Exhibit

## METAL WORK TOOLS

### PENCIL TRAY

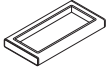

MODEL NO./DESCRIPTION	LIST PRICE	DIMENSIONS					CARTONED WEIGHT	CUBIC FEET
		D	W	H	A	KW		
NAC0510PTB	\$ 72	5	10	1	—	—	1 lbs.	0.1

- Available in Black only

### METAL TOOLS OPERATING LOAD CAPACITIES

Component:	Operating Load Capacity (Functional Loads):
Metal shelves:	10 lbs. per 6" of shelf width
Single side tray:	40 lbs. t.w.
Double side tray:	47 lbs. t.w.
Pocket organizer:	4 lbs. t.w.
Slant Sorter:	19 lbs. t.w.
Binder shelf:	10 lbs. t.w.
Pencil tray:	5 lbs. t.w.

**PRODUCT SPECIFICATIONS**

• For use with Exhibit and Epicenter slat wall inserts

**TO ORDER, SPECIFY:**

1. Model Number

**SAMPLE MODEL NUMBER:**

NACCP

• See pages 306-307 for all options available in Exhibit

**PLASTIC WORK TOOLS**

	MODEL NO./DESCRIPTION	LIST PRICE	DIMENSIONS						CARTONED WEIGHT	CUBIC FEET
			D	W	H	A	KW			
 <p><b>PENCIL CUP</b></p>	NACCP Black Plastic	\$ 40	½	4	4	–	–	1 lbs.	0.4	
	NACPC Clear Plastic	40	½	4	4	–	–	1 lbs.	0.4	

• Holds pencils, pens, rulers, etc.

**LEGAL PAPER TRAY**

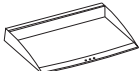
	NAC1115SPT Black Plastic	\$ 60	10½	15	2	–	–	1 lbs.	0.1
	NAC1115SPTC Clear Plastic	60	10½	15	2	–	–	1 lbs.	0.1

• Holds letter or legal width papers, folders, etc.

**ACCESSORY TRAY**

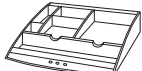
	NAC1010AT Black Plastic	\$ 53	10	9½	2	–	–	1 lbs.	0.2
	NAC1010ATC Clear Plastic	53	10	9½	2	–	–	1 lbs.	0.2

• Holds supplies such as pens, pencils, paper clips, scissors, erasers, rulers, etc.

**PHONE HOLDER**

	NACPH Black Plastic	\$ 53	9½	8½	2	–	–	1 lbs.	0.1
	NACPHC Clear Plastic	53	9½	8½	2	–	–	1 lbs.	0.1

• Holds telephone

**BINDER SHELF**

	NACBS Black Plastic	\$ 45	10½	5	9	–	–	1 lbs.	0.3
---	---------------------	-------	-----	---	---	---	---	--------	-----

• Holds binders and folders  
• Not recommended for use under Epicenter mounted overhead storage cabinets

**SLANT SORTER**

	NACSS Black Plastic	\$ 62	12½	7	7½	–	–	1 lbs.	0.2
	NACSSC Clear Plastic	62	12½	7	7½	–	–	1 lbs.	0.2

• Holds folders, papers, etc.  
• Not recommended for use under Epicenter mounted overhead storage cabinets

# EXHIBIT

## PRODUCT SPECIFICATIONS

- For use with Exhibit and Epicenter slat wall inserts

## TO ORDER, SPECIFY:

1. Model Number

## SAMPLE MODEL NUMBER:

NACMAPSMB

- See pages 306-307 for all options available in Exhibit

	MODEL NO./DESCRIPTION	LIST PRICE	DIMENSIONS					CARTONED CUBIC	
			D	W	H	A	KW	WEIGHT	FEET
<b>INTUITIVE MONITOR ARM SLAT WALL MOUNT</b>	NACMA1SFB Black	\$ 601	29½	2½	13¼	–	–	12 lbs.	2.7
	NACMA1SFS Silver	601	29½	2½	13¼	–	–	12 lbs.	2.7

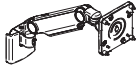

- Weight capacity: 5.5 lbs. minimum - 13 lbs. pounds
- 1 monitor arm every 24" on slat wall and only 1 monitor arm recommended for a slat/tack combo insert
- Must properly install slat wall and Epicenter supports when using a monitor arm
- Recommended to not use monitor arm on the upper 4 slats of a full slat wall and slat wall combo insert

## MONITOR ARM INFORMATION

National Model	NACMA1SFB/S
Description	slat wall mount black/silver
Monitor Rotation	port/landscape 360°
Monitor Extension	6¼" - 13¾"
Arm Pivot	30°
Horizontal Monitor Pivot	180°
Monitor Weight Capacity (maximum approved weight)	arm – 5.5 lbs. minimum - 13 lbs. maximum slat rail – 13 lbs.
Mounting Option	slat wall mount
Arm Height Adjustment	10" dynamic
Pole Height	N/A
Maximum Width Per Monitor	no maximum width
Manual Height Adjustment	N/A
Worksurface Requirements— Desk Clamp	N/A (slat wall mount only)
Worksurface Requirements— Grommet Mount	N/A (slat wall mount only)