KOZMIC

Product Specifications	310
Fabrics and Options	311
Contrasting Fabrics Specifications	312
Product Pages	313
Typicals	320
COM Yardage Requirements	322



KOZMIC PRODUCT SPECIFICATIONS

SPINE CONSTRUCTION

- Interior frame is constructed of plywood with tenon joints
- 1" of high grade polyurethane foam covers the top of spine
- Each unit includes ganging brackets that also serve as wire management

SPINE LEGS AND GLIDES

- Aluminum legs available in polished or powder coated Concrete, Cinder, Iron, Platinum Metallic, or Satin Nickel Metallic
- Features a black 1½" adjustable leveling glide
- White, soft leveling glides with 1½" adjustment are available for an additional upcharge

SEAT CONSTRUCTION

- 3" of high grade polyurethane foam covers a plywood seat construction

IMPROMPTU SEATING CASTERS

- Black, 37 mm double wheel, roll control casters are standard. Casters are free rolling when sitting on unit
- Black, 50 mm double wheel, braking casters are available for an additional upcharge. Casters are non-rolling when sitting on unit
- Recommend braking casters for use on hard floors

IMPROMPTU SEATING GLIDES

- Black 1½" adjustable leveling glides are standard
- White, soft glides with 1½" adjustment are available for an additional upcharge

UPHOLSTERY DETAIL

- Contrasting fabric available on all models

TABLES

- 1" thick worksurfaces are laminate with PVC softened rim or clear PVC exposed plywood rim
- 1" thick bistro worksurfaces are laminate with clear exposed plywood edge
- CSL option available, except bistro table

TABLE LEGS

- Steel rectangular legs with 2" adjustable glides available in powder coated Concrete, Cinder, Iron, Platinum Metallic, or Satin Nickel Metallic

POWER AND USB GROMMET OPTION

- UL Listed
- Non-sequential "daisy chain" solution
- Use of 1 circuit allows 26 power grommets to be linked together
- Use of 2 circuits allows 52 power grommets to be linked together
- Field installable
- Grommet available in white, black, light grey and dark grey
- USB grommet features 2 USB ports
- Power grommet features 1 power outlet

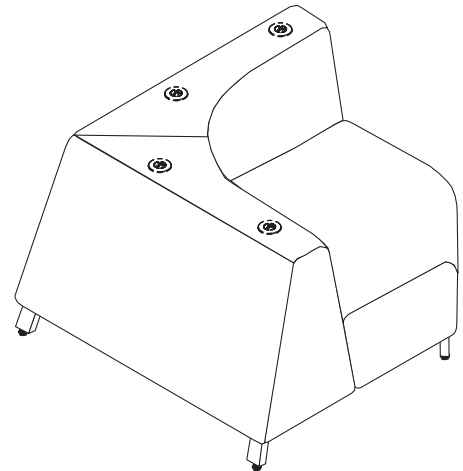

All Kozmic models may be ordered to meet TB133 fire code.

To order seating to meet the TB133 fire code, specify an "F" at the end of the model number (Ex: N87IN3616CF).

For TB133 pricing go to www.NationalOfficeFurniture.com/TB133

Please consult customer service for applicable Arc-Com, COM, Designtex, Maharam, Momentum, Stinson, or Ultrafabrics fabric.

FABRICS

Grade 1	Cali Input Plush Ridge Stardust Vessel	Grade 3	COL Jacks Silvertex	Grade 6	Essence/Ultraleather
Grade 2	Bliss Brilliant COM Dorset Orbit Phrase Pixie Sedona Strand	Grade 4	Connect Four Echo Masquerade	Grade 7	Brisa Brisa Distressed Reef Pro Silica Silica Etch Tottori
		Grade 5	Mode	Grade L7	Davenport
				Grade L8	Florence

LAMINATE WORKSURFACES

WOODGRAIN LAMINATE	PATTERN LAMINATE
AC2 Autumn 2	814 White Tigris
AD Almond	818 Crisp Linen
CL Caramel	819 Flax Gauze
CW Cordovan	821 Elemental Concrete
DW Judicial	822 Smoke Quarstone
HN2 Honey 2	874 Bronze Legacy
IM Brighton	
MC Amber	
MH Mocha	
NM Natural	
PB Portobello	
PT Portico	
SK Skyline	
SM Sonoma	
TF Truffle	
792 Sable	
793 Acorn*	

*Acorn is the laminate complement to Clear Walnut finish

SOLID LAMINATE

405 Designer White
419 Wallaby
425 Shadow
440 Cloud
461 Graphite
462 Cinder
478 Platinum Grey
488 Frosty White
491 Designer White Linear
492 Cinder Linear

• CSL available; see page 28 for program details and upcharge

GALLERY LAMINATE

Grade 1 – 5% upcharge
G1001 Citadel
G1011 Pepperdust
Grade 2 – 6% upcharge
G1002 Planked Raw Oak
G1003 Evening Notte
G1004 Kirsche
G1005 Midnight Run
G1006 Sepia Walnut
G1007 Serotina
G1008 Timeless
G1009 White Nebbia
G1012 Phantom Ecu

RIM PROFILE

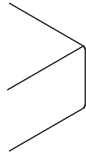

Softened PVC

PVC SOFTENED RIM

AC2 Autumn 2
AD Almond
CL Caramel
CW Cordovan
DW Judicial
HN2 Honey 2
IM Brighton
MC Amber
MH Mocha
NM Natural
PB Portobello
PT Portico
SK Skyline
SM Sonoma
TF Truffle
405 Designer White
419 Wallaby
425 Shadow
440 Cloud
461 Graphite
462 Cinder
478 Platinum Grey
488 Frosty White
491 Designer White Linear
492 Cinder Linear
792 Sable
793 Acorn

GALLERY PVC SOFTENED RIM

Grade 1 – 5% upcharge
G1001 Citadel
G1011 Pepperdust
Grade 2 – 6% upcharge
G1002 Planked Raw Oak
Grade 3 – 6% upcharge
G1003 Evening Notte
G1004 Kirsche
G1005 Midnight Run
G1006 Sepia Walnut
G1007 Serotina
G1008 Timeless
G1009 White Nebbia
G1012 Phantom Ecu

CASTERS - IMPROMPTU SEATING

C59	Roll Control (standard)
C60	Braking (add \$38 list)

GLIDES

STD	Hard (standard)
C10	White Soft (add \$30 list)

GROMMET CUTOUT OPTIONS

If no grommet cutout is desired, specify an X (No Grommet)

CUTOUT OPTION FOR G32

(\$25 list upcharge per cutout)

CUT-1G32	Cutout, 1 grommet per unit
CUT-2G32	Cutout, 2 grommets per unit
CUT-3G32	Cutout, 3 grommets per unit
CUT-4G32	Cutout, 4 grommets per unit
CUT-5G32	Cutout, 5 grommets per unit

Grommets sold separately; reference pages 318-319 for model numbers and pricing.

SPINE AND SEAT LEG PAINT COLORS

265	Polished
423	Concrete
462	Cinder
463	Iron
501	Platinum Metallic
503	Satin Nickel Metallic

See page 28 for Gallery program details and upcharges

KOZMIC

TO ORDER CONTRASTING FABRIC, SPECIFY

KOZMIC

Inline Spine page 313

T-Spine page 313

L-Spine page 314

120° Spine page 314

1. Model Number plus "X"
2. Back Fabric Grade Number/Cover Number
3. Back Accent Fabric Grade Number/Cover Number
4. Upholstery Fabric Grade Number/Cover Number
5. Seat Fabric Grade Number/Cover Number (when applicable)
6. Extreme Fabric Grade Number/Cover Number (when applicable)
7. Grommet
8. Leg
9. Glide

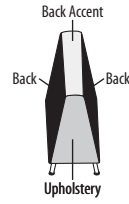

Extreme location not available

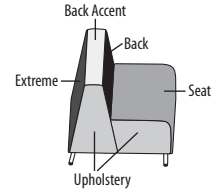

Extreme location not available on 2 seat model

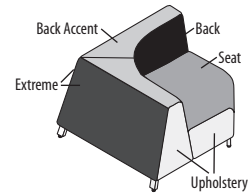
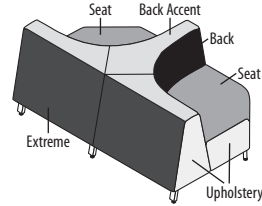

Impromptu - Bench page 315

Impromptu - 120° page 315

1. Model Number plus "X"
2. Seat Fabric Grade Number/Cover Number (when applicable)
3. Upholstery Fabric Grade Number/Cover Number
4. Leg Paint Color
5. Caster/Glide

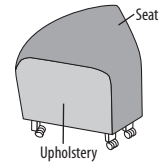

Contrasting Fabric

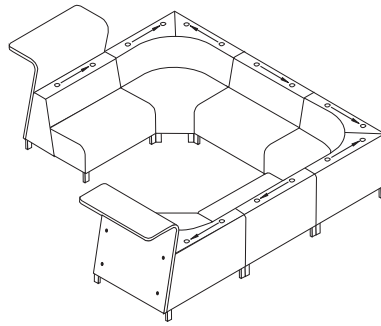
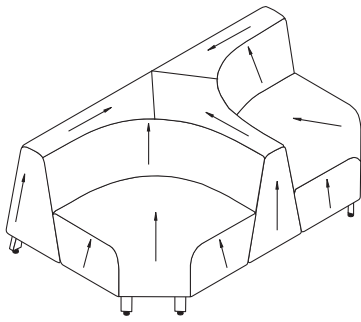

TO ORDER, SPECIFY:

1. Model Number
2. Fabric Grade / Cover Number
3. Grommet
4. Leg Paint Color
5. Glide

• See page 311 for Kozmic options
See page 322 for COM fabric yardage

Directional fabrics with distinct repeats may not align, therefore are not recommended on the back accent location. Arrows indicate fabric direction.

INLINE SPINE

MODEL NO.

GRADE / LIST PRICE

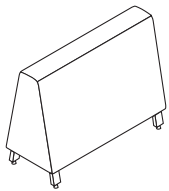

		1	2/COM	3/COL	4	5	6	7	L7	L8
N87AAA36	Inline Spine	\$ 1101	1148	1168	1203	1239	1302	1386	1785	1915
N87AS1A36	Inline Spine - Single Seat	2201	2293	2330	2398	2470	2592	2755	3530	3782
N87AS2A36	Inline Spine - Double Seat	3359	3489	3541	3637	3738	3911	4141	5236	5591

DIMENSIONS

Width	36	Seat Width	36	Weight	53	Cubic Ft.	13.3
Depth	15¾	Seat Depth	18	Weight - Single Seat	93.1	Cubic Ft. - Single Seat	26.2
Depth with Single Seat	31	Seat Height	16	Weight - Double Seat	131.5	Cubic Ft. - Double Seat	35.7
Depth with Double Seat	46¾						
Height	27¾						

- Contrasting fabric option - specify X (i.e. N87AAA36X); see page 312. For list pricing, use your electronic specification tool or contact customer service
- Worksurfaces can be added to any spine in the field
- Ganging brackets are included with each spine
- Ganging brackets serve as wire management
- Grommet cutout option CUT-2G32 is available

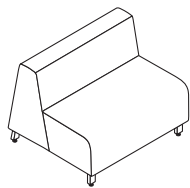

Single Seat

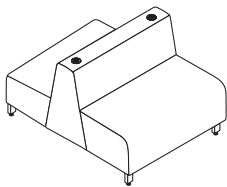

Double Seat shown with grommet option

T-SPINE

		1	2/COM	3/COL	4	5	6	7	L7	L8
N87TA	T-Spine	\$ 2781	2886	2929	3007	3089	3230	3417	4306	4595
N87TSA	T-Spine with Seats	5562	5731	5800	5925	6056	6281	6581	8006	8468

DIMENSIONS

Width	66¾	Seat Height	16	Weight	106.1	Cubic Ft.	56.6
Depth	40¾			Weight with Seats	201.8	Cubic Ft. with Seats	56.6
Height	27¾						

- Contrasting fabric option - specify X (i.e. N87TAX); see page 312. For list pricing, use your electronic specification tool or contact customer service
- Worksurfaces can be added to any spine in the field
- Ganging brackets are included with each spine
- Ganging brackets serve as wire management
- Grommet cutout option CUT-5G32 is available

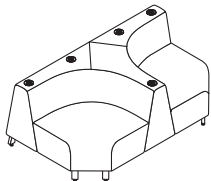
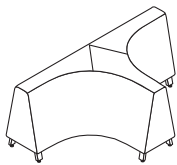

T-Spine with Seats shown with grommet option

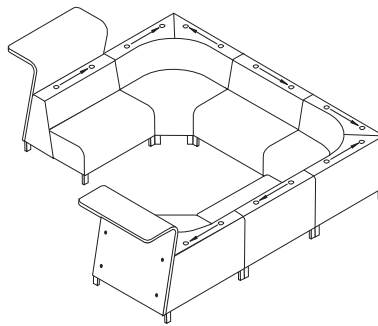
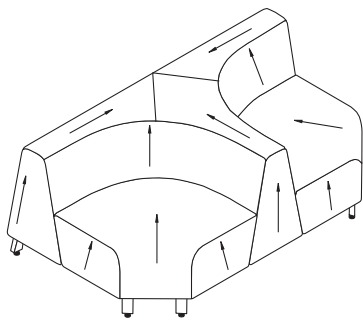

TO ORDER, SPECIFY:

1. Model Number
2. Fabric Grade / Cover Number
3. Grommet
4. Leg Paint Color
5. Glide

• See page 311 for Kozmic options

See page 322 for COM fabric yardage

Directional fabrics with distinct repeats may not align, therefore are not recommended on the back accent location. Arrows indicate fabric direction.

L-SPINE

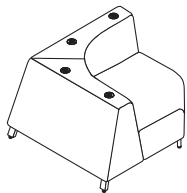
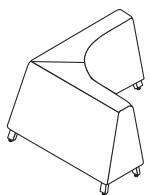

L-Spine with Seat shown with grommet option

MODEL NO.

GRADE / LIST PRICE

		1	2/COM	3/COL	4	5	6	7	L7	L8
N87LALAR	L-Spine	\$ 1450	1545	1583	1653	1727	1853	2021	2819	3078
N87LSALAR	L-Spine with Seat	2896	3026	3078	3174	3275	3448	3678	4773	5128

DIMENSIONS

Width	40¾	Seat Height	16	Weight	110.9	Cubic Ft.	33.8
Depth	40¾	Weight with Seat	140.9	Cubic Ft. with Seat	33.8		
Height	27¾						

- Contrasting fabric option - specify X (i.e. N87LALARX); see page 312. For list pricing, use your electronic specification tool or contact customer service
- Worksurfaces can be added to any spine in the field
- Ganging brackets are included with each spine
- Ganging brackets serve as wire management
- Grommet cutout option CUT-4G32 is available

120° SPINE

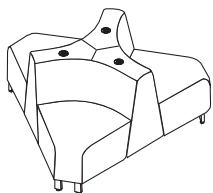
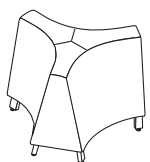

120° Spine with Seats shown with grommet option

		1	2/COM	3/COL	4	5	6	7	L7	L8
N87C120	120° Spine	\$ 1913	1991	2023	2081	2142	2247	2386	3047	3262
N87CS120	120° Spine with Seats	4694	4843	4903	5013	5129	5327	5591	6845	7252

DIMENSIONS

Width	38¾	Height	27¾	Weight	106.1	Cubic Ft.	26.2
Width with Seat	54	Seat Height	16	Weight with Seats	174.8	Cubic Ft. with Seats	52.4
Depth	33¾						
Depth with Seats	47						

- Contrasting fabric option - specify X (i.e. N87C120X); see page 312. For list pricing, use your electronic specification tool or contact customer service
- Worksurfaces can be added to any spine in the field
- Ganging brackets are included with each spine
- Ganging brackets serve as wire management
- Grommet cutout option CUT-3G32 is available

TO ORDER, SPECIFY:

1. Model Number
2. Fabric Grade / Cover Number
3. Leg Paint Color
4. Caster/Glide

- See page 311 for Kozmic options
- See page 322 for COM fabric yardage

IMPROMPTU - BENCH

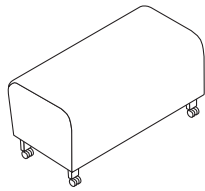

Mobile

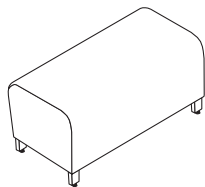

Static

MODEL NO.

GRADE / LIST PRICE

			1	2/COM	3/COL	4	5	6	7	L7	L8
N87IN3616C	Mobile, 16"	\$	1234	1281	1301	1336	1372	1435	1519	1918	2048
N87IN3616G	Static, 16"		1205	1252	1272	1307	1343	1406	1490	1889	2019
N87IN3618C	Mobile, 18"		1286	1335	1354	1390	1428	1493	1579	1990	2123
N87IN3618G	Static, 18"		1258	1307	1326	1362	1400	1465	1551	1962	2095

16" DIMENSIONS

Width	36
Depth	17
Height	16
Weight	43.6
Cubic Ft.	9.1

18" DIMENSIONS

Width	36
Depth	17½
Height	18
Weight	45.6
Cubic Ft.	9.1

- Contrasting fabric option - specify X (i.e. N87IN3616CX); see page 312. For list pricing, use your electronic specification tool or contact customer service
- Add ½" to height for braking caster option
- 18" models recommended for use with seated height worksurfaces
- Braking casters are recommended for use on hard floors

IMPROMPTU - 120°

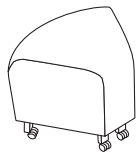

Mobile

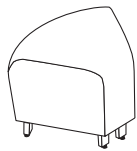

Static

			1	2/COM	3/COL	4	5	6	7	L7	L8
N87CR12016C	Mobile, 16"	\$	985	1023	1038	1066	1096	1146	1213	1532	1636
N87CR12016G	Static, 16"		927	965	980	1008	1038	1088	1155	1474	1578
N87CR12018C	Mobile, 18"		1019	1057	1072	1100	1130	1180	1247	1566	1670
N87CR12018G	Static, 18"		962	1000	1015	1043	1073	1123	1190	1509	1613

16" DIMENSIONS

Width	24½
Depth	19
Height	16
Weight	27.7
Cubic Ft.	5.7

18" DIMENSIONS

Width	25½
Depth	19¼
Height	18
Weight	29.7
Cubic Ft.	5.7

- Contrasting fabric option - specify X (i.e. N87CR12016CX); see page 312. For list pricing, use your electronic specification tool or contact customer service
- Add ½" to height for braking caster option
- 18" models recommended for use with seated height worksurfaces
- Braking casters are recommended for use on hard floors

TO ORDER, SPECIFY:

• See page 311 for Kozmic options

1. Model Number
2. Rim Profile / Color (when applicable)
3. Grommet
4. Laminate Color

RECTANGULAR WORKSURFACES

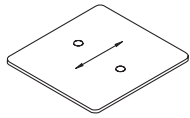

36x38 shown with grommet option

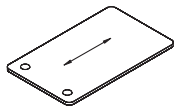

29x48 shown with grommet option

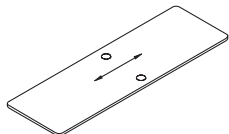

29x96 shown with grommet option

MODEL NO.		LIST PRICE	DEPTH	WIDTH	CARTONED WEIGHT	CUBIC FEET
N87TRT3638L	36x38 - PVC Softened Rim	\$ 782	36	38	59 lbs.	2.6
N87TRT2948L	29x48 - PVC Softened Rim	782	29	48	62 lbs.	2.1
N87TRT2996L	29x96 - PVC Softened Rim	1101	29	96	122 lbs.	3.9
N87TRT3638DL	36x38 - PVC Exposed Plywood Rim	\$ 782	36	38	59 lbs.	2.6
N87TRT2948DL	29x48 - PVC Exposed Plywood Rim	782	29	48	62 lbs.	2.1
N87TRT2996DL	29x96 - PVC Exposed Plywood Rim	1101	29	96	122 lbs.	3.9

- Grommet cutout option CUT-2G32 available
- Worksurface attachment will deface spine
- 29" x 48" must be used with 2 legs
- 29" x 96" must be used with 4 legs; used to span across spine, provides a work surface for users on each side
- 36" x 38" rectangular work surface is to be attached to a 120° to maintain proper stability
- N87TRT2996L and N87TRT2996DL work surface includes undersurface support rail
- N87TRT3638L and N87TRT3638DL Grommet location - 9" from edge 19" to center
- N87TRT2948L and N87TRT2948DL Grommet location - 5½" from side edge and 2" from top edge
- N87TRT2996L and N87TRT2996DL Grommet location - 5½" from side edge and 46" to center
- Arrows indicate grain direction

WORKSURFACE EXTENSION

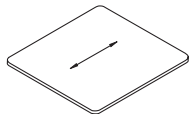

N87TRTE3638L	36x38 - PVC Softened Rim	\$ 667	36	38	59 lbs.	2.6
N87TRTE3638DL	36x38 - PVC Exposed Plywood Rim	667	36	38	59 lbs.	2.6

- Grommet cutout option not available
- Can only be used as an extension off the 120° surface
- Must be supported by 2 legs
- Arrow indicates grain direction

120° WORKSURFACE

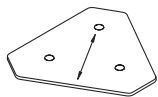

Shown with grommet option

N87TRD120L	120° - PVC Softened Rim	\$ 985			67 lbs.	4.9
N87TRD120DL	120° - PVC Exposed Plywood Rim	985			67 lbs.	4.9

- Grommet cutout option CUT-3G32 available
- Worksurface attachment will deface spine
- For use only with 120° spine"
- Grommet location - 9" from edge
- Arrow indicates grain direction

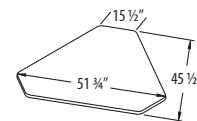

WEDGE WORKSURFACE



Shown with grommet option CUT-1G32

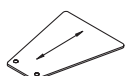

Shown with grommet option CUT-2G32

N87TWG4860L	Wedge - PVC Softened Rim	\$ 1245			90 lbs.	4.0
N87TWG4860DL	Wedge - PVC Exposed Plywood Rim	1245			90 lbs.	4.0

- Grommet cutout option CUT-1G32 or CUT-2G32 available
- Worksurface attachment will deface spine
- Must be supported by 2 legs
- Grommet cutout option CUT-1G32 is for attachment of the work surface off the end of a spine
- Grommet cutout option CUT-2G32 is for attachment of the work surface off the side of a spine
- Worksurface includes undersurface support rail
- Grommet CUT-1G32 is 9" from attachment edge
- Grommet CUT-2G32 is 2" from attachment edge
- Arrow indicates grain direction

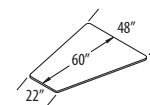

TO ORDER, SPECIFY:

• See page 311 for Kozmic options

1. Model Number
2. Laminate Color (when applicable)

BISTRO TABLE

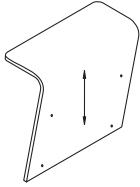

MODEL NO.	LIST PRICE	DEPTH	WIDTH	CARTONED WEIGHT	CUBIC FEET
N87TSH36L	\$ 1970	36	44½	73 lbs.	15

- Grommet cutout option not available
- Worksurface attachment will deface spine
- Exposed plywood edge, always clear
- Bistro table can be attached to any L or T spines (with or without integrated seating)
- Bistro table surfaces may not align when placed side by side
- When attaching a bistro table to an inline spine, the following must apply:
 - Spine with bistro table is ganged to an L, T or 120° spine (with or without integrated seating) or;
 - Bistro table is attached to an inline spine with integrated seating
- Attachment hardware in black and silver included
- Worksurface height is 44½" from top of surface to the floor
- CSL not available
- Arrow indicates grain direction

RECTANGULAR TABLE LEGS



CBV0228RTB	Black, 1 per Package	\$ 151		6 lbs.	0.51
CBV0228RTC	Concrete, 1 per Package	151		6 lbs.	0.51
CBV0228RTI	Iron, 1 per Package	151		6 lbs.	0.51
CBV0228RTS	Platinum Metallic, 1 per Package	151		6 lbs.	0.51
CBV0228RTN	Satin Nickel Metallic, 1 per Package	151		6 lbs.	0.51

- Specify model number only
- Legs can be attached to worksurface at different angles

POWER ENTRY



Plug View

NAC72ELE4H	Electrical Power Entry (Hardwire) + 4WC	\$ 151	Circuits 1 and 2	1.95 lbs.	0.38
NAC48ELE4P	48" Electrical Power Entry (20 amp Plug)	220	Circuit 1	1.95 lbs.	0.38
NAC72ELE4P	72" Electrical power entry (20 amp Plug)	249	Circuit 1	2.45 lbs.	0.38

- Specify model number only
- Must be ordered with power or USB grommet and electrical kits
- 1 power entry is necessary to power 1 or multiple units

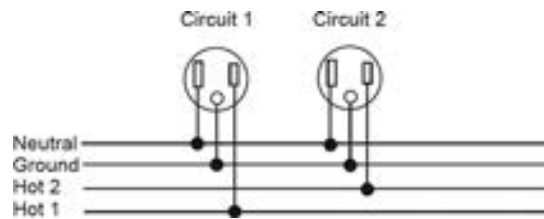

KOZMIC

TO ORDER, SPECIFY:

• See page 311 for Kozmic options

1. Model Number

ELECTRICAL KITS	MODEL NO.	LIST PRICE	CARTONED WEIGHT	CUBIC FEET
	NACEL4KTA1	1 H-Block, 42" Jumper Male / Male End \$ 105	1.36 lbs.	0.38
	NACEL4KTA2	2 – H-Block 1 - 42" Jumper Male / Male End 1 - 20" Jumper Male / Male End	2.34 lbs.	0.38
	NACEL4KTA3	3 – H-Block 2 - 42" Jumper Male / Male End 1 - 20" Jumper Male / Male End	3.20 lbs.	0.38

- Specify model number only
- Use specification guide below to determine necessary power or pass thru kits for each unit

ELECTRICAL KIT SPECIFICATION GUIDE

COMPONENT	FOR POWER OPTION, SPECIFY:	FOR PASS THRU OPTION (NON-POWER UNITS), SPECIFY:
Inline Spine	NACEL4KTA1	NACEL4KTA1
120° Spine	NACEL4KTA2	NACEL4KTA1
L-Spine	NACEL4KTA2	NACEL4KTA2
T-Spine	NACEL4KTA3	NACEL4KTA3

POWER GROMMET

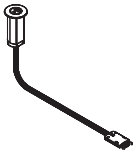

NACG32P1ELW	Circuit 1, White	\$ 174	1.23 lbs.	0.15
NACG32P1ELB	Circuit 1, Black	174	1.23 lbs.	0.15
NACG32P1ELG	Circuit 1, Light Grey	174	1.23 lbs.	0.15
NACG32P1ELD	Circuit 1, Dark Grey	174	1.23 lbs.	0.15
NACG32P2ELW	Circuit 2, White	\$ 174	1.23 lbs.	0.15
NACG32P2ELB	Circuit 2, Black	174	1.23 lbs.	0.15
NACG32P2ELG	Circuit 2, Light Grey	174	1.23 lbs.	0.15
NACG32P2ELD	Circuit 2, Dark Grey	174	1.23 lbs.	0.15

- Specify model number only
- Must use with power entry and electrical kits
- Features 1 power outlet
- Each circuit allows 26 power grommets to be linked together
- Circuit 2 grommets not compatible with plugged infeed

USB GROMMET

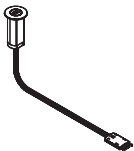

NACG32U1ELW	Circuit 1, White	\$ 278	1.23 lbs.	0.15
NACG32U1ELB	Circuit 1, Black	278	1.23 lbs.	0.15
NACG32U1ELG	Circuit 1, Light Grey	278	1.23 lbs.	0.15
NACG32U1ELD	Circuit 1, Dark Grey	278	1.23 lbs.	0.15
NACG32U2ELW	Circuit 2, White	\$ 278	1.23 lbs.	0.15
NACG32U2ELB	Circuit 2, Black	278	1.23 lbs.	0.15
NACG32U2ELG	Circuit 2, Light Grey	278	1.23 lbs.	0.15
NACG32U2ELD	Circuit 2, Dark Grey	278	1.23 lbs.	0.15

- Specify model number only
- Must use with power entry and electrical kits
- Features 2 USB ports
- Circuit 1 option allows 26 power grommets to be linked together
- Circuit 2 grommets not compatible with plugged infeed

TO ORDER, SPECIFY:

1. Model Number

**POWER GROMMET
CHICAGO HARDWARE**

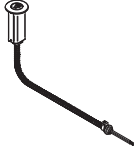

MODEL NO.		LIST PRICE	CARTONED WEIGHT	CUBIC FEET
NACG32PELHW	White, 3' Length	\$ 243	1.23 lbs.	0.15
NACG32PELHB	Black, 3' Length	243	1.23 lbs.	0.15
NACG32PELHG	Light Grey, 3' Length	243	1.23 lbs.	0.15
NACG32PELHD	Dark Grey, 3' Length	243	1.23 lbs.	0.15
NACG32PELH6W	White, 6' Length	\$ 243	1.23 lbs.	0.15
NACG32PELH6B	Black, 6' Length	243	1.23 lbs.	0.15
NACG32PELH6G	Light Grey, 6' Length	243	1.23 lbs.	0.15
NACG32PELH6D	Dark Grey, 6' Length	243	1.23 lbs.	0.15

- Specify model number only
- Features 1 power outlet
- Recommend 3' with inline and 120° spines
- Recommend 6' with T and L spines
- No power entry required

**USB GROMMET
CHICAGO HARDWARE**



NACG32UELHW	White, 3' Length	\$ 347	1.23 lbs.	0.15
NACG32UELHB	Black, 3' Length	347	1.23 lbs.	0.15
NACG32UELHG	Light Grey, 3' Length	347	1.23 lbs.	0.15
NACG32UELHD	Dark Grey, 3' Length	347	1.23 lbs.	0.15
NACG32UELH6W	White, 6' Length	\$ 347	1.23 lbs.	0.15
NACG32UELH6B	Black, 6' Length	347	1.23 lbs.	0.15
NACG32UELH6G	Light Grey, 6' Length	347	1.23 lbs.	0.15
NACG32UELH6D	Dark Grey, 6' Length	347	1.23 lbs.	0.15

- Specify model number only
- Features 2 USB ports
- Recommend 3' with inline and 120° spines
- Recommend 6' with T and L spines
- No power entry required

GANGING BRACKET

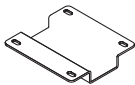

N87BR1	Ganging Bracket Kit	\$ 36	3 lbs.	0.15
--------	---------------------	-------	--------	------

- Serves as wire management
- All spine units include necessary ganging brackets
- Only need to order ganging brackets if extra brackets are wanted or need replacement brackets

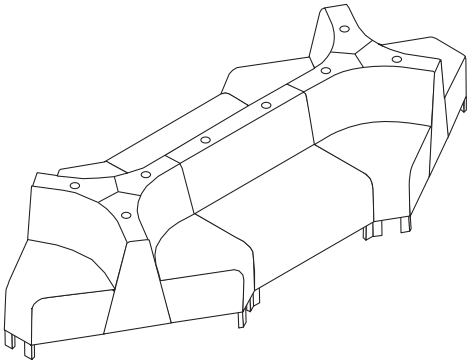

Shown with power grommet options

MODEL NO.	QUANTITY	DESCRIPTION	GRADE 1 LIST PRICE
NON-POWERED			
N87CS120	(2)	120° Spine with Seats	\$ 4694 ea
N87AS2A36	(1)	Inline Spine - Double Seat	3359
Total			\$ 12,747

POWERED - shown with all optional locations powered

N87CS120 / CUT-3G32	(2)	120° Spine with Seats with Grommet CUT	\$ 4769 ea
N87AS2A36 / CUT-2G32	(1)	Inline Spine - Double Seat with Grommet CUT	3409
NAC48ELE4P	(1)	48" Power Entry - Circuit 1	220
NACG32P1ELW	(4)	Power Grommet - Circuit 1	174 ea
NACG32U1ELW	(4)	USB Grommet - Circuit 1	278 ea
NACEL4KTA1	(1)	Inline Spine Power Kit	105
NACEL4KTA2	(2)	120° Spine Power Kit	197 ea
Total			\$ 15,474

Note: Ganging brackets are included with each spine and do not need to be ordered separately. They also serve as wire management.

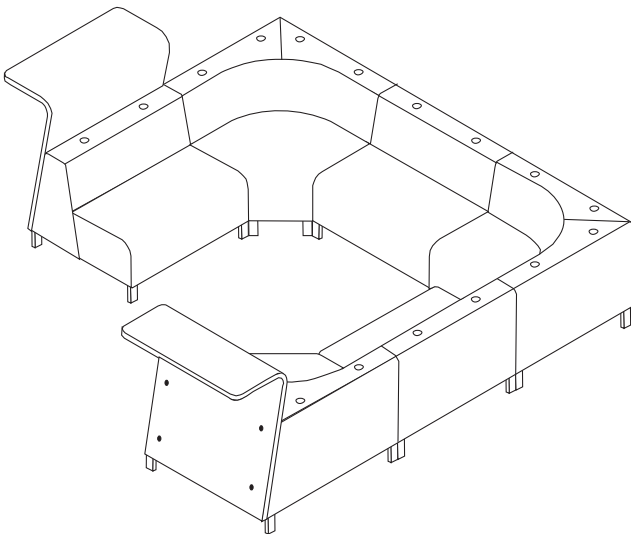

Shown with power grommet options

MODEL NO.	QUANTITY	DESCRIPTION	GRADE 1 LIST PRICE
NON-POWERED			
N87AS1A36	(3)	Inline Spine - Single Seat	\$ 2201 ea
N87LSALAR	(3)	L-Spine with Seat	2896 ea
N87TSH36L	(2)	Bistro Table	1970 ea
Total			\$ 19,231

POWERED - shown with all optional locations powered

N87AS1A36 / CUT-2G32	(3)	Inline Spine - Single Seat with Grommet CUT	\$ 2251 ea
N87LSALAR / CUT-4G32	(3)	L-Spine with Seat with Grommet CUT	2996 ea
NAC48ELE4P	(1)	48" Power Entry - Circuit 1	220
NACG32P1ELW	(9)	Power Grommet - Circuit 1	174 ea
NACG32U1ELW	(9)	USB Grommet - Circuit 1	278 ea
NACEL4KTA1	(3)	Inline Spine Power Kit	105 ea
NACEL4KTA2	(3)	L-Spine Power Kit	197 ea
N87TSH36L	(2)	Bistro Table	1970 ea
Total			\$ 24,875

Note: Ganging brackets are included with each spine and do not need to be ordered separately. They also serve as wire management.

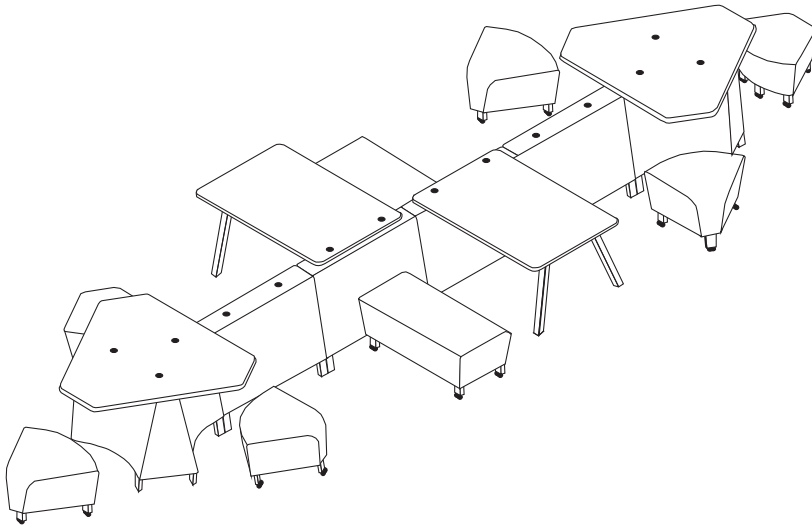

Shown with power grommet options

MODEL NO.	QUANTITY	DESCRIPTION	GRADE 1 LIST PRICE
NON-POWERED			
N87C120	(2)	120° Spine	\$ 1913 ea
N87AAA36	(4)	Inline Spine	1101 ea
N87CR12018C	(6)	Impromptu 120 mobile	1019 ea
N87IN3618C	(2)	Impromptu Bench mobile	1286 ea
N87TRD120L	(2)	120 Worksurface	985 ea
N87TRT2948L	(2)	29x48 Worksurface	782 ea
CBV0228RTB	(4)	Table Leg	151 ea
Total			\$ 21,054

POWERED - shown with all optional locations powered

N87C120 / CUT-3G32	(2)	120° Spine with Grommet CUT	\$ 1988 ea
N87AAA36 / CUT-2G32	(4)	Inline Spine with Grommet CUT	1151 ea
N87CR12018C	(6)	Impromptu 120 mobile	1019 ea
N87IN3618C	(2)	Impromptu Bench mobile	1286 ea
N87TRD120L / CUT-3G32	(2)	120 Worksurface with Grommet CUT	1060 ea
N87TRT2948L / CUT-2G32	(2)	29x48 Worksurface with Grommet CUT	832 ea
CBV0228RTB	(4)	Table Leg	151 ea
NAC48ELE4P	(1)	48" Power Entry - Circuit 1	220
NACG32P1ELW	(7)	Power Grommet - Circuit 1	174 ea
NACG32U1ELW	(7)	USB Grommet - Circuit 1	278 ea
NACEL4KTA1	(4)	Inline Spine Power Kit	105 ea
NACEL4KTA2	(2)	120° Spine Power Kit	197 ea
Total			\$ 25,852

Note: Ganging brackets are included with each spine and do not need to be ordered separately. They also serve as wire management.

COM YARDAGE REQUIREMENTS

COM YARDAGE REQUIREMENTS (54" WIDTH – CUT UP THE ROLL)

MODEL	RAILROADED Contact customer service 800-482-1717 for ydg requirements	NON DIRECTIONAL OR SOLID	1"-4" REPEAT	5"-11" REPEAT	12"-18" REPEAT	COL SQUARE FEET
			4" VERTICAL X 4" HORIZONTAL	11" VERTICAL X 11" HORIZONTAL	18" VERTICAL X 18" HORIZONTAL	
N87AAA36		2.10	2.50	3.90	3.30	42
N87AAA36X	Back	1.50	1.80	2.10	2.30	29
	Back Accent	1.10	1.20	1.20	1.50	21
	Upholstery	0.80	1.00	1.20	1.30	15
N87C120		2.80	3.20	3.90	5.00	52
N87C120X	Back	2.30	2.50	3.20	3.50	44
	Back Accent	0.80	0.80	1.80	1.80	12
	Upholstery	0.80	1.10	2.20	2.20	16
N87TA		4.00	3.00	4.00	6.90	79
N87TAX	Back	1.30	1.80	2.40	2.40	32
	Back Accent	1.20	1.30	2.40	2.40	23
	Upholstery	0.80	1.10	2.40	2.30	16
	Extreme	1.50	1.80	2.40	2.40	29
N87LALAR		3.00	3.80	4.50	4.80	59
N87LALARX	Back	1.00	1.10	1.20	1.80	18
	Back Accent	1.10	1.30	1.80	1.90	22
	Upholstery	0.80	1.00	1.70	1.70	16
	Extreme	1.50	1.80	2.20	2.30	29
N87AS1A36		3.00	3.70	5.00	5.20	59
N87AS1A36X	Back	0.80	1.00	1.20	1.30	15
	Back Accent	1.10	1.20	1.20	1.50	21
	Upholstery	0.80	1.00	1.70	1.80	15
	Extreme	0.50	1.00	1.20	1.30	15
	Seat	1.30	1.40	1.80	2.00	25
N87AS2A36		4.50	5.30	6.20	6.70	88
N87AS2A36X	Back	1.50	1.80	2.10	2.30	29
	Back Accent	1.10	1.20	1.20	1.50	21
	Upholstery	1.10	1.40	2.60	2.80	22
	Seat	3.00	3.50	3.80	5.20	61
N87CS120		4.10	5.00	8.00	9.50	82
N87CS120X	Back	2.20	2.50	3.40	3.50	44
	Back Accent	0.60	0.80	1.80	1.80	12
	Upholstery	1.50	2.00	3.80	3.80	30
	Seat	2.10	2.80	5.20	5.20	42
N87TSA		6.20	5.40	6.30	8.30	123
N87TSAX	Back	1.30	1.80	2.40	2.40	31
	Back Accent	1.20	1.30	2.40	2.40	23
	Upholstery	0.80	1.10	2.30	2.40	16
	Extreme	1.50	1.80	2.40	2.40	29
	Seat	2.30	2.50	2.80	2.90	47
N87LSALAR		4.00	4.60	5.50	5.30	78
N87LSALARX	Back	1.00	1.10	1.20	1.80	18
	Back Accent	1.10	1.30	1.80	1.90	22
	Upholstery	1.50	1.70	2.40	2.40	29
	Extreme	1.50	1.80	2.20	2.30	29
	Seat	1.20	1.40	1.70	1.70	24
N87IN3616C, N87IN3616G		1.50	0.60	2.40	2.70	30
N87IN3616CX, N87IN3616GX	Upholstery	0.40	0.70	0.90	1.80	8
	Seat	1.20	1.50	1.80	2.20	24
N87IN3618C, N87IN3618G		1.80	2.00	2.40	3.30	35
N87IN3618CX, N87IN3618GX	Upholstery	0.50	0.70	0.90	1.80	10
	Seat	1.40	1.50	1.90	2.30	26
N87CR12016C, N87CR12016G		1.00	1.50	1.80	2.80	20
N87CR12016CX, N87CR12016GX	Upholstery	0.40	0.70	0.90	1.80	8
	Seat	1.00	1.10	1.80	2.30	19
N87CR12018C, N87CR12018G		1.30	1.60	2.10	2.80	25
N87CR12018CX, N87CR12018GX	Upholstery	0.50	0.70	0.90	1.80	10
	Seat	1.00	1.10	2.00	2.30	20