OCCASIONAL TABLES

Arrowood	488
Barrington	489
Confide	490
Eloquence	491
Epic	492
Escalade	493
Farrah	494
Footings	495
Marnia	496
Myriad	500
Reno	505
Roosevelt	507
Staccato	508
Swift	512
Tag	514
Tessera	515
Universal	516
Wixler	522

ARROWOOD OCCASIONAL TABLES



Shaded model numbers are available on our "To You in 10 Days or Less" Quick Delivery program and will be delivered in 10 days or less.

TO ORDER, SPECIFY:

1. Model Number
2. Finish/Laminate Color

SAMPLE MODEL NUMBER:

31N2040MGLW HN

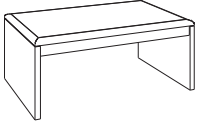
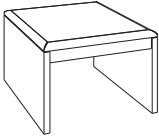
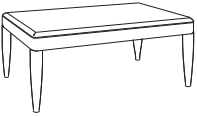
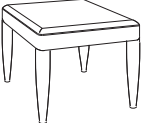
	MODEL NO./DESCRIPTION	LIST PRICE	DIMENSIONS					CARTONED CUBIC	
			D	W	H	A	KW	WEIGHT	FEET
ARROWOOD MAGAZINE TABLE PANEL LEGS 	31N2040MGLW HPL Top	\$ 840	19 ³ / ₄	39 ¹ / ₂	16	¹ / ₄	—	67 lbs.	12.2
	<ul style="list-style-type: none"> • Reference Arrowood for detailed product information, finishes and entire Arrowood offering starting on page 38 in the Casegoods Book 1 Price List 								
ARROWOOD END TABLE PANEL LEGS 	31N2424ENLW HPL Top	\$ 764	23 ³ / ₄	23 ¹ / ₂	19	¹ / ₄	—	63 lbs.	11.0
	<ul style="list-style-type: none"> • Reference Arrowood for detailed product information, finishes and entire Arrowood offering starting on page 38 in the Casegoods Book 1 Price List 								
ARROWOOD MAGAZINE TABLE TURNED LEGS 	Q31N2040MGPLW HPL Top	\$ 1217	19 ²⁵ / ₃₂	39 ²⁵ / ₃₂	17 ⁷ / ₁₆	—	—	42 lbs.	3.0
	31N2040MGPLW HPL Top	1217	19 ²⁵ / ₃₂	39 ²⁵ / ₃₂	17 ⁷ / ₁₆	—	—	42 lbs.	3.0
	<ul style="list-style-type: none"> • Some assembly required • Reference Arrowood for detailed product information, finishes and entire Arrowood offering starting on page 38 in the Casegoods Book 1 Price List 								
ARROWOOD END TABLE TURNED LEGS 	Q31N2424ENPLW HPL Top	\$ 1139	23 ²⁵ / ₃₂	23 ²⁵ / ₃₂	20 ⁷ / ₁₆	—	—	33 lbs.	2.2
	31N2424ENPLW HPL Top	1139	23 ²⁵ / ₃₂	23 ²⁵ / ₃₂	20 ⁷ / ₁₆	—	—	33 lbs.	2.2
	<ul style="list-style-type: none"> • Some assembly required • Reference Arrowood for detailed product information, finishes and entire Arrowood offering starting on page 38 in the Casegoods Book 1 Price List 								

BARRINGTON OCCASIONAL TABLES



Shaded model numbers are available on our "To You in 10 Days or Less" Quick Delivery program and will be delivered in 10 days or less.

TO ORDER, SPECIFY:

1. Model Number
2. Finish/Laminate Color

SAMPLE MODEL NUMBERS:

50N2040MGW DW
50N2040MGQW MH

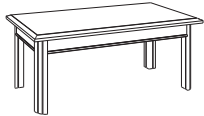
	MODEL NO./DESCRIPTION	LIST PRICE	DIMENSIONS					CARTONED CUBIC	
			D	W	H	A	KW	WEIGHT	FEET
BARRINGTON MAGAZINE TABLE 	Q50N2040MGW Wood Top	\$ 1173	19 $\frac{3}{4}$	39 $\frac{3}{4}$	18 $\frac{3}{16}$	—	—	42 lbs.	3.0
	50N2040MGW Wood Top	1173	19 $\frac{3}{4}$	39 $\frac{3}{4}$	18 $\frac{3}{16}$	—	—	42 lbs.	3.0
	50N2040MGLW HPL Top	1017	19 $\frac{3}{4}$	39 $\frac{3}{4}$	18 $\frac{3}{16}$	—	—	42 lbs.	3.0

- Some assembly required
- HPL top tables have veneer legs/bases
- Reference Barrington for detailed product information, finishes and entire Barrington offering starting on page 60 in the Casegoods Book 1 Price List

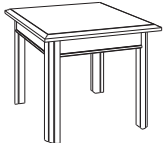
BARRINGTON END TABLE 	Q50N2424ENW Wood Top	\$ 1032	23 $\frac{3}{4}$	23 $\frac{3}{4}$	22 $\frac{3}{16}$	—	—	38 lbs.	2.8
	50N2424ENW Wood Top	1032	23 $\frac{3}{4}$	23 $\frac{3}{4}$	22 $\frac{3}{16}$	—	—	38 lbs.	2.8
	50N2424ENLW HPL Top	906	23 $\frac{3}{4}$	23 $\frac{3}{4}$	22 $\frac{3}{16}$	—	—	38 lbs.	2.8

- Some assembly required
- HPL top tables have veneer legs/bases
- Reference Barrington for detailed product information, finishes and entire Barrington offering starting on page 60 in the Casegoods Book 1 Price List

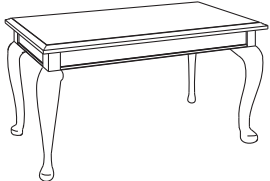
BARRINGTON QUEEN ANNE MAGAZINE TABLE 	50N2040MGQW Wood Top	\$ 1618	19 $\frac{3}{4}$	39 $\frac{3}{4}$	18 $\frac{3}{16}$	—	—	36 lbs.	3.0
---	----------------------	---------	------------------	------------------	-------------------	---	---	---------	-----

- Some assembly required
- Reference Barrington for detailed product information, finishes and entire Barrington offering starting on page 60 in the Casegoods Book 1 Price List

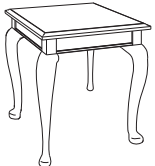
BARRINGTON QUEEN ANNE END TABLE 	50N2424ENQW Wood Top	\$ 1524	23 $\frac{3}{4}$	23 $\frac{3}{4}$	22 $\frac{3}{16}$	—	—	32 lbs.	3.3
---	----------------------	---------	------------------	------------------	-------------------	---	---	---------	-----

- Some assembly required
- Reference Barrington for detailed product information, finishes and entire Barrington offering starting on page 60 in the Casegoods Book 1 Price List

CONFIDE OCCASIONAL TABLES

TO ORDER, SPECIFY:

1. Model Number
2. Finish/Laminate Color
3. Metal Color

SAMPLE MODEL NUMBER:

N78SNW MC 462

	MODEL NO./DESCRIPTION	LIST PRICE	DIMENSIONS					CARTONED WEIGHT	CUBIC FEET
			D	W	H	A	KW		
CONFIDE END TABLE	N78SNW Wood	\$ 1233	21¼	22	16½	—	—	15 lbs.	6.8
	N78SNL Laminate	1233	21¼	22	16½	—	—	15 lbs.	6.8



- Soft glide option available for a \$32 list upcharge
- Reference Confide for detailed product information, finishes and entire Confide offering starting on page 94 in the Seating Price List

CONFIDE MAGAZINE TABLE	N78SMW Wood	\$ 1917	21¼	44	16½	—	—	24 lbs.	14.2
	N78SML Laminate	1917	21¼	44	16½	—	—	24 lbs.	14.2

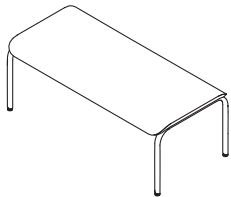

- Soft glide option available for a \$32 list upcharge
- Reference Confide for detailed product information, finishes and entire Confide offering starting on page 94 in the Seating Price List

ELOQUENCE OCCASIONAL TABLES

TO ORDER, SPECIFY:

- 1. Model Number
- 2. Finish/Laminate Color

SAMPLE MODEL NUMBER:

85N2024EN CL

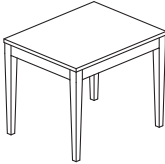

MODEL NO./DESCRIPTION	LIST PRICE	DIMENSIONS				A	KW	CARTONED WEIGHT	CUBIC FEET
		D	W	H					
85N2024EN Wood Top	\$ 998	24 ⁷ / ₁₆	21 ¹ / ₂	20 ¹ / ₈	—	—	19 lbs.	1.4	
85N2024ENLW Laminate Top	998	24 ⁷ / ₁₆	21 ¹ / ₂	20 ¹ / ₈	—	—	19 lbs.	1.4	

- Some assembly required
- Reference Eloquence for detailed product information, finishes and entire Eloquence offering starting on page 154 in the Seating Price List

ELOQUENCE MAGAZINE TABLE

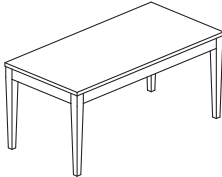

85N2040MG Wood Top	\$ 1147	19 ² / ₃₂	39 ⁷ / ₈	18 ³ / ₃₂	—	—	26 lbs.	2.2
85N2040MGLW Laminate Top	1147	19 ² / ₃₂	39 ⁷ / ₈	18 ³ / ₃₂	—	—	26 lbs.	2.2

- Some assembly required
- Reference Eloquence for detailed product information, finishes and entire Eloquence offering starting on page 154 in the Seating Price List

OCCASIONAL TABLES

EPIC OCCASIONAL TABLES

TO ORDER, SPECIFY:

1. Model Number
2. Surface Grommet
3. Side Grommet
4. Paint
5. Finish/Laminate Color

SAMPLE MODEL NUMBER:

25N2424ENW X X 462 MC

	MODEL NO./DESCRIPTION	LIST PRICE	DIMENSIONS					CARTONED CUBIC	
			D	W	H	A	KW	WEIGHT	FEET
EPIC END TABLE	25N2424ENW Wood	\$ 1744	24	24	18 $\frac{3}{8}$	—	—	55 lbs.	12.6
	25N2424ENL Laminate	1513	24	24	18 $\frac{3}{8}$	—	—	55 lbs.	12.6

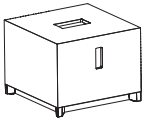
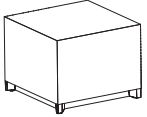

Optional Surface and Side Grommet Locations

- Features metal base and feet in 3 color options
- Optional surface grommet cutout available in G12, G17, and G23 cutout (+\$25 list)
- Optional side grommet cutout available in G23 cutout (+\$25 list)
- Power grommet sold separately; reference pages 547-549, 554-557, and 560 for pricing and details
- Optional glass and solid surface kits available; reference page 520
- Reference Epic for detailed product information, finishes and entire Epic offering starting on page 94 in the Casegoods Book 2 Price List

EPIC MAGAZINE TABLE	25N2448MGW Wood	\$ 1868	24	48	14 $\frac{3}{4}$	—	—	77 lbs.	19.1
	25N2448MGL Laminate	1645	24	48	14 $\frac{3}{4}$	—	—	77 lbs.	19.1

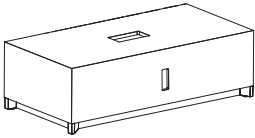
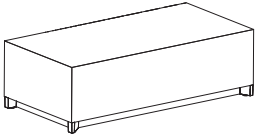

Optional Surface and Side Grommet Locations

- Features metal base and feet in 3 color options
- Optional surface grommet cutout available in G12, G17, and G23 cutout (+\$25 list)
- Optional side grommet cutout available in G23 cutout (+\$25 list)
- Power grommet sold separately; reference pages 547-549, 554-557, and 560 for pricing and details
- Optional glass and solid surface kits available; reference page 520
- Reference Epic for detailed product information, finishes and entire Epic offering starting on page 94 in the Casegoods Book 2 Price List

EPIC COFFEE TABLE	25N3636MGW Wood	\$ 1944	36	36	14 $\frac{1}{16}$	—	—	65 lbs.	15.0
	25N3636MGL Laminate	1722	36	36	14 $\frac{1}{16}$	—	—	65 lbs.	15.0

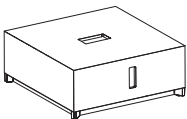
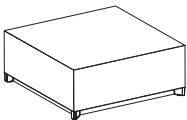

Optional Surface and Side Grommet Locations

- Features metal base and feet in 3 color options
- Optional surface grommet cutout available in G12, G17, and G23 cutout (+\$25 list)
- Optional side grommet cutout available in G23 cutout (+\$25 list)
- Power grommet sold separately; reference pages 547-549, 554-557, and 560 for pricing and details
- Optional glass and solid surface kits available; reference page 520
- Reference Epic for detailed product information, finishes and entire Epic offering starting on page 94 in the Casegoods Book 2 Price List

ESCALADE OCCASIONAL TABLES





Shaded model numbers are available on our "To You in 10 Days or Less" Quick Delivery program and will be delivered in 10 days or less.

TO ORDER, SPECIFY:

1. Model Number
2. Finish

SAMPLE MODEL NUMBER:

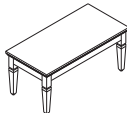
ECN2040MGW MC

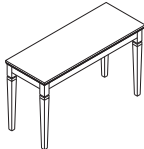
	MODEL NO./DESCRIPTION	LIST PRICE	DIMENSIONS					CARTONED CUBIC	
			D	W	H	A	KW	WEIGHT	FEET
ESCALADE MAGAZINE TABLE 	QECN2040MGW	\$ 1650	19¾	39¾	18	—	—	70 lbs.	4.3
	ECN2040MGW	\$ 1650	19¾	39¾	18	—	—	70 lbs.	4.3
	<ul style="list-style-type: none"> • Reference Escalade for detailed product information, finishes and entire Escalade offering starting on page 82 in the Casegoods Book 1 Price List 								
ESCALADE END TABLE 	QECN2424ENW	\$ 1549	23 ¹ / ₁₆	23 ¹ / ₁₆	24	—	—	40 lbs.	3.9
	ECN2424ENW	1549	23 ¹ / ₁₆	23 ¹ / ₁₆	24	—	—	40 lbs.	3.9
	<ul style="list-style-type: none"> • Reference Escalade for detailed product information, finishes and entire Escalade offering starting on page 82 in the Casegoods Book 1 Price List 								
ESCALADE CONSOLE TABLE 	ECN1948CSW	\$ 1844	18 ⁷ / ₁₆	48	28½	—	—	85 lbs.	4.9
	<ul style="list-style-type: none"> • Rim detail on 3 sides of unit • Reference Escalade for detailed product information, finishes and entire Escalade offering starting on page 82 in the Casegoods Book 1 Price List 								

OCCASIONAL TABLES

FARRAH OCCASIONAL TABLES

TO ORDER, SPECIFY:

1. Model Number
2. Wood/Laminate Finish (when applicable)
3. Solid Surface Grade/Color (when applicable)
4. Frame Color (when applicable)
5. Glides (when applicable)

SAMPLE MODEL NUMBERS:

N71T2525ENL CW 462 STD
N71T2525ENS C 7302 462 STD

FARRAH END TABLE

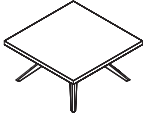

MODEL NO./DESCRIPTION	LIST PRICE		DIMENSIONS					CARTONED WEIGHT	CUBIC FEET
	GRADE A	GRADE C	D	W	H	A	KW		
N71T2525ENL Laminate	\$ 1582		25	25	14	—	—	64 lbs.	10.4
N71T2525ENDLW Laminate - Exposed Plywood Rim	1765		25	25	14	—	—	64 lbs.	10.4
N71T2525ENW Veneer	1886		25	25	14	—	—	64 lbs.	10.4
N71T2525ENDW Veneer - Exposed Plywood Rim	2069		25	25	14	—	—	64 lbs.	10.4
N71T2525ENS Solid Surface	2646	2937	25	25	14	—	—	71 lbs.	10.4

• Reference Farrah for detailed product information, finishes and entire Farrah offering starting on page 180 in the Seating Price List

FARRAH MAGAZINE TABLE

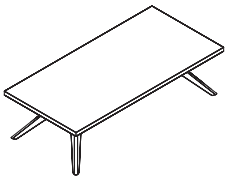

MODEL NO./DESCRIPTION	LIST PRICE		DIMENSIONS					CARTONED WEIGHT	CUBIC FEET
	GRADE A	GRADE C	D	W	H	A	KW		
N71T2552MGL Laminate	\$ 2069		51½	24½	14	—	—	112 lbs.	19.7
N71T2552MGDLW Laminate - Exposed Plywood Rim	2250		51½	24½	14	—	—	112 lbs.	19.7
N71T2552MGW Veneer	2373		51½	24½	14	—	—	112 lbs.	19.7
N71T2552MGDW Veneer - Exposed Plywood Rim	2556		51½	24½	14	—	—	112 lbs.	19.7
N71T2552MGS Solid Surface	3527	4126	51½	24½	14	—	—	126 lbs.	19.7

• Reference Farrah for detailed product information, finishes and entire Farrah offering starting on page 180 in the Seating Price List

FARRAH GANGING CENTER TABLE

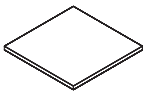

MODEL NO./DESCRIPTION	LIST PRICE		DIMENSIONS					CARTONED WEIGHT	CUBIC FEET
	GRADE A	GRADE C	D	W	H	A	KW		
N71TCL Laminate	\$ 486		25	25	14	—	—	24.5 lbs.	1.5
N71TCDLW Laminate - Exposed Plywood Rim	548		25	25	14	—	—	24.5 lbs.	1.5
N71TCW Veneer	792		25	25	14	—	—	24.5 lbs.	1.5
N71TCDW Veneer - Exposed Plywood Rim	852		25	25	14	—	—	24.5 lbs.	1.5
N71TCS Solid Surface	1458	1749	25	25	14	—	—	31.5 lbs.	1.5

• 2 metal attachment brackets and hardware included

• Reference Farrah for detailed product information, finishes and entire Farrah offering starting on page 180 in the Seating Price List

FOOTINGS OCCASIONAL TABLES

TO ORDER, SPECIFY:

1. Model Number
2. Paint Color
3. Foot Paint Color

SAMPLE MODEL NUMBER:

CBV245015YBKP 265 265

	MODEL NO./DESCRIPTION	LIST PRICE	DIMENSIONS					KW	CARTONED WEIGHT	CUBIC FEET
			D	W	H	A				
FOOTINGS X BASE OCCASIONAL HEIGHT	CBV2115XBP	\$ 426	20 ⁹ / ₁₆	20 ⁹ / ₁₆	14 ¹ / ₁₆	—	—	26 lbs.	4.2	
	CBV2715XBP	481	27 ¹ / ₄	27 ¹ / ₄	14 ¹ / ₁₆	—	—	28 lbs.	6.3	
	CBV3215XBP	536	31 ¹ / ₁₆	31 ¹ / ₁₆	14 ¹ / ₁₆	—	—	28 lbs.	7.9	

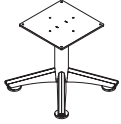

- 1¹/₈" diameter glide
- Reference Footings for detailed product information, finishes and entire Footings offering starting on page 182

FOOTINGS X BASE END TABLE HEIGHT	CBV2119XBP	\$ 456	20 ⁹ / ₁₆	20 ⁹ / ₁₆	18	—	—	28 lbs.	5.1
	CBV2719XBP	486	27 ¹ / ₄	27 ¹ / ₄	18	—	—	29 lbs.	7.8

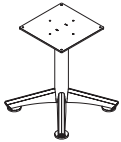

- Reference Footings for detailed product information, finishes and entire Footings offering starting on page 182

FOOTINGS Y BASES WITH RAIL OCCASIONAL HEIGHT	CBV183115YBKP	\$ 671	30 ³ / ₁₆	18 ¹ / ₁₆	14 ¹ / ₁₆	—	—	49 lbs.	7.1
	CBV183515YBKP	700	34 ⁷ / ₁₆	18 ¹ / ₁₆	14 ¹ / ₁₆	—	—	49 lbs.	7.2
	CBV243815YBKP	731	38 ⁵ / ₁₆	24	14 ¹ / ₁₆	—	—	51 lbs.	9.8
	CBV244415YBKP	761	44 ⁵ / ₁₆	24	14 ¹ / ₁₆	—	—	52 lbs.	9.8
	CBV245015YBKP	792	50 ³ / ₁₆	24	14 ¹ / ₁₆	—	—	52 lbs.	9.8



- 1¹/₈" diameter glide
- Reference Footings for detailed product information, finishes and entire Footings offering starting on page 182

MARNIA OCCASIONAL TABLES

PRODUCT SPECIFICATIONS

TOPS

- Laminate surfaces are 1" HPL (high pressure laminate)
- Veneer surfaces are 1" plain sliced slipmatched cherry (Amber, Autumn, Mocha, Truffle) or maple veneer (Brighton, Caramel, Honey, Natural), plain sliced bookmatched walnut veneer (Clear Walnut, Cordovan, Judicial), quarter cut walnut veneer (Almond, Portobello, Sable), or quarter cut oak veneer (Sonoma)
- When specifying Clear Walnut, a clear coat finish, the natural wood characteristics of walnut veneer are visible. These characteristics include, but are not limited to, color and woodgrain variation.
- Solid surface is 1" thick
- Back painted glass surfaces (round tops only) have a 1" thick top including the glass and white substrate
- Grain direction runs parallel to the metal frame on square and rectangle models

RIM PROFILES

- Veneer models have a matching 3mm veneer edge band
- Laminate models have a matching 3mm PVC edge band
- Back painted glass has a MDF core with 3D Laminate edge
- Solid surface worksurface have a matching 3mm radius edge

UPHOLSTERED TOPS

- ¾" high grade polyurethane foam covers a ¾" solid base panel

LEGS

- 2 metal base styles; the round tables will have an "X" base for the 30" and 40" models and a "Y" base for the 16" and 24" diameter models, the square and rectangles will have an open style base

FINISH APPLICATION

- All Veneer surfaces feature a semi-open pore matte finish

**TOP
WOOD FINISHES**

- AC Autumn
- AD Almond
- CL Caramel
- CW Cordovan
- DW Judicial
- EW Clear Walnut*
- HN Honey
- IM Brighton
- MC Amber
- MH Mocha
- NM Natural
- PB Portobello
- SM Sonoma
- TF Truffle
- 792 Sable

TOP LAMINATE COLORS

WOODGRAIN LAMINATE

- AC2 Autumn 2
- AD Almond
- BZ Brazilwood
- CI Chai
- CL Caramel
- CW Cordovan
- DW Judicial
- HN2 Honey 2
- IM Brighton
- KN Kona
- MC Amber
- MH Mocha
- NM Natural
- PB Portobello
- PC Porcini
- PT Portico
- SK Skyline
- SM Sonoma
- TF Truffle
- WL Willow
- 792 Sable
- 793 Acorn*

SOLID LAMINATE

- 405 Designer White
- 419 Wallaby
- 425 Shadow
- 440 Cloud
- 457 Dapple
- 461 Graphite
- 462 Cinder
- 478 Platinum Grey
- 488 Frosty White
- 491 Designer White Linear
- 492 Cinder Linear

GALLERY LAMINATE

- Grade 1 – 5% upcharge
- G1001 Citadel
- G1011 Pepperdust
- Grade 2 – 6% upcharge
- G1002 Planked Raw Oak
- G1003 Evening Notte
- G1004 Kirsche
- G1005 Midnight Run
- G1006 Sepia Walnut
- G1007 Serotina
- G1008 Timeless
- G1009 White Nebbia
- G1012 Phantom Ecu

See page 18 for Gallery program details and upcharges

*Acorn is the laminate complement to Clear Walnut finish

**LEG
PAINT COLORS**

- 405 Designer White
- 423 Concrete
- 462 Cinder
- 463 Iron
- 501 Platinum Metallic
- 503 Satin Nickel Metallic

SOLID SURFACE TOP OPTIONS

COLORS

- 7101 Bisque (Grade A)
- 7201 Glacier White (Grade A)
- 7202 Canyon (Grade B)
- 7203 Designer White (Grade B)
- 7204 Silt (Grade B)
- 7301 Concrete (Grade C)
- 7302 Deep Night Sky (Grade C)
- 7303 Deep Nocturne (Grade C)

RIM PROFILE

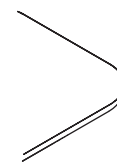

MARNIA OCCASIONAL TABLES

PRODUCT SPECIFICATIONS

- Wood, Laminate, Glass, and Solid Surface worksurface available on round tops. See page 497 for options
- Upholstered top available for 16" round table only. See pages 10-17 for fabric options
- Legs are metal. See page 497 for color options
- Round tops are shipped KD

TO ORDER, SPECIFY:

1. Model Number
2. Wood Finish/Laminate Color
3. Solid Surface Grade/Color
4. Leg Paint Color

SAMPLE MODEL NUMBERS:

89N2422TRDW PB 463
89N2422TRDS C 7305 463

- See page 497 for all options available in Occasional Tables

MODEL NO./DESCRIPTION	LIST PRICE			DIMENSIONS					CARTONED CUBIC		
	GRADE A	GRADE B	GRADE C	D	W	H	A	KW	WEIGHT	FEET	
ROUND TABLE	16" ROUND			DI	H						
	89N1616TRDL	Laminate	\$ 1284	16	—	16	—	—		2.7	
	89N1616TRDG	White Back Painted Glass	1589	16	—	16	—	—		2.7	
	89N1616TRDS	Solid Surface	1766	16	—	16	—	—		2.7	
		Grade	1	2/COM	3/COL	4	5	6	7	L7	L8
	89N1616TRDF	Fabric	\$ 1567	1587	1595	1610	1625	1652	1687	1855	1909

ALLIANCE GRADE / LIST PRICE

	A	B	C	D	E	F	G	H	I	J
\$	1600	1620	1636	1652	1671	1690	1706	1726	1746	1766
	K	L	M	N	O	P	Q	R	S	T
\$	1797	1860	1900	1920	1941	1961	1981	2001	2021	2041

DIMENSIONS

Diameter 16
Height 16½" Cubic Ft. 2.7

- Veneer top is not an option on 16" round tops
- See fabric guidelines on page 14 of the Tables Price List
- Ships KD in 2 cartons

ROUND TABLE



MODEL NO./DESCRIPTION	GRADE A	GRADE B	GRADE C	DI	H		
24" ROUND							
89N2422TRDW	Wood	\$ 1970		24	—	22	— — 6.0
89N2422TRDL	Laminate	1516		24	—	22	— — 6.0
89N2422TRDG	White Back Painted Glass	2176		24	—	22	— — 6.0
89N2422TRDS	Solid Surface	2365	2481	2633	24	—	22 — — 6.0
30" ROUND							
89N3016TRDW	Wood	\$ 2161		30½	—	16	— — 5.7
89N3016TRDL	Laminate	1801		30½	—	16	— — 5.7
89N3016TRDG	White Back Painted Glass	2773		30½	—	16	— — 5.7
89N3016TRDS	Solid Surface	2918	3099	3337	30½	—	16 — — 5.7
40" ROUND							
89N4016TRDW	Wood	\$ 2842		40	—	16	— — 12.6
89N4016TRDL	Laminate	2369		40	—	16	— — 12.6
89N4016TRDG	White Back Painted Glass	3970		40	—	16	— — 12.6
89N4016TRDS	Solid Surface	4093	4415	4837	40	—	16 — — 12.6

- Ships KD in 2 cartons

MARNIA OCCASIONAL TABLES

PRODUCT SPECIFICATIONS

- Wood, Laminate, and Solid Surface available on square tops. See page 497 for options
- Legs are metal. See page 497 for color options
- Square and Rectangular tops shipped assembled
- Wood and Laminate tops have 3mm edge



TO ORDER, SPECIFY:

1. Model Number
2. Wood Finish/Laminate Color
3. Solid Surface Grade/Color
4. Leg Paint Color

SAMPLE MODEL NUMBERS:

89N242422TSQW PB 463
89N182722TRTW PB 463

- See page 497 for all options available in Occasional Tables

	MODEL NO./DESCRIPTION		LIST PRICE			DIMENSIONS					CARTONED WEIGHT	CUBIC FEET		
			GRADE A	GRADE B	GRADE C	D	W	H	A	KW				
SQUARE TABLE  	24" SQUARE													
	89N242422TSQW	Wood	\$	2247				24	24	22	–	–	12.7	
	89N242422TSQL	Laminate		1728				24	24	22	–	–	12.7	
	89N242422TSQS	Solid Surface		2697	2813	2965			24	24	22	–	–	12.7
	30" SQUARE													
	89N303016TSQW	Wood	\$	2192					30%	30%	16	–	–	14.2
	89N303016TSQL	Laminate		1755					30%	30%	16	–	–	14.2
	89N303016TSQS	Solid Surface		2960	3141	3379			30%	30%	16	–	–	14.2
	40" SQUARE													
89N404016TSQW	Wood	\$	2584					40	40	16	–	–	23.4	
89N404016TSQL	Laminate		2153					40	40	16	–	–	23.4	
89N404016TSQS	Solid Surface		3875	4197	4619			40	40	16	–	–	23.4	

- Tops have cutouts to accept base. On laminate models, cutout will always be painted black. On Veneer models, cutout will match finish specified

RECTANGLE TABLE

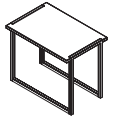

	MODEL NO./DESCRIPTION		LIST PRICE			DIMENSIONS					CARTONED WEIGHT	CUBIC FEET		
			GRADE A	GRADE B	GRADE C	D	W	H	A	KW				
18" x 27" RECTANGLE														
	89N182722TRTW	Wood	\$	2100				18	27	22	–	–	11.1	
	89N182722TRTL	Laminate		1615				18	27	22	–	–	11.1	
	89N182722TRTS	Solid Surface		2520	2619	2748			18	27	22	–	–	11.1
20" x 42" RECTANGLE														
	89N204216TRTW	Wood	\$	2158				20	42	16	–	–	13.6	
	89N204216TRTL	Laminate		1726				20	42	16	–	–	13.6	
	89N204216TRTS	Solid Surface		2914	3082	3303			20	42	16	–	–	13.6

- Tops have cutouts to accept base. On laminate models, cutout will always be painted black. On Veneer models, cutout will match finish specified

MYRIAD OCCASIONAL TABLES

BOX AND FLOATING TOP SIZES

End Table 24" x 24"
 Coffee Table 36" x 36"
 Magazine Table 24" x 48"
 Console Table 18" x 50"

CUBE SIZES

End Table 24" x 24"
 Coffee Table 36" x 36"
 Magazine Table 24" x 48"

CYLINDER SIZES

End Table 24" Diameter
 Coffee Table 36" Diameter

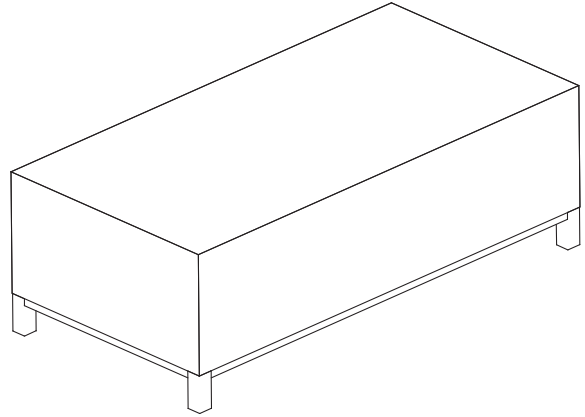

GLASS TOP KITS AVAILABLE FOR

Box styles
 Cube styles
 Cylinder styles

WOOD FINISHES

AC Autumn
 CL Caramel
 CW Cordovan
 DW Judicial
 HN Honey
 IM Brighton
 MC Amber
 MH Mocha
 NM Natural
 TF Truffle

- Veneer tables are plain sliced slipmatched cherry (Amber, Autumn, Mocha, Truffle), maple veneer (Brighton, Caramel, Honey, Natural), or plain sliced bookmatched walnut veneer (Cordovan, Judicial)

LAMINATES

WOODGRAIN LAMINATE

AC2 Autumn 2
 AD Almond
 BZ Brazilwood
 CI Chai
 CL Caramel
 CW Cordovan
 DW Judicial
 HN2 Honey 2
 IM Brighton
 KN Kona
 MC Amber
 MH Mocha
 NM Natural
 PB Portobello
 PC Porcini
 PT Portico
 SK Skyline
 SM Sonoma
 TF Truffle
 WL Willow
 792 Sable
 793 Acorn

SOLID LAMINATE

405 Designer White
 419 Wallaby
 425 Shadow
 440 Cloud
 457 Dapple
 461 Graphite
 462 Cinder
 478 Platinum Grey
 488 Frosty White
 491 Designer White Linear
 492 Cinder Linear

PATTERN LAMINATE

814 White Tigris
 818 Crisp Linen
 819 Flax Gauze
 821 Elemental Concrete
 822 Smoke Quarstone
 874 Bronze Legacy

GALLERY LAMINATE

Grade 1 – 5% upcharge
 G1001 Citadel
 G1011 Pepperdust
 Grade 2 – 6% upcharge
 G1002 Planked Raw Oak
 G1003 Evening Notte
 G1004 Kirsche
 G1005 Midnight Run
 G1006 Sepia Walnut
 G1007 Serotina
 G1008 Timeless
 G1009 White Nebbia
 G1012 Phantom Ecru

See page 18 for Gallery program details and upcharges

FINISH APPLICATION

- All Veneer surfaces feature a semi-open pore matte finish

METAL COLORS

423 Concrete
 462 Cinder
 463 Iron
 497 Polished Aluminum
 501 Platinum Metallic
 503 Satin Nickel Metallic

GLASS OPTION

3 Clear

SURFACE GROMMET OPTION

If no grommet is desired, specify an X (No Grommet)

CUT-G12C Cutout only for G12 1 Touch Pivoting Power Grommet
 CUT-G17C Cutout only for G17 1 Touch Pivoting Power Grommet
 CUT-G23C Cutout only for G23 Power Grommet

- Power grommet is optional for box, cube and cylinder styles

SIDE GROMMET OPTION

If no grommet is desired, specify an X (No Grommet)

CUT-G23C Cutout only for G23 Power Grommet

- Power grommet is optional for box, cube and cylinder styles

DIMENSION KEY

D Depth
 W Width
 H Height
 A Overhang: Approach Side
 KW Kneespace Width
 DI Diameter

MYRIAD OCCASIONAL TABLES

TO ORDER, SPECIFY:

1. Model Number
2. Surface Grommet
3. Side Grommet
4. Paint
5. Finish/Laminate Color

SAMPLE MODEL NUMBER:

91NB2424ENW X X 501 MH

• See page 500 for all options available in Occasional Tables

MYRIAD BOX

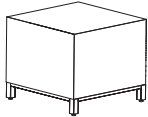

End Table

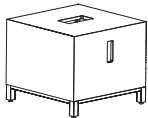

Optional Surface and Side Grommet Locations

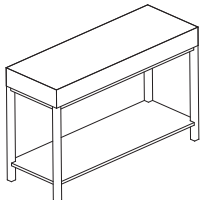

Console Table

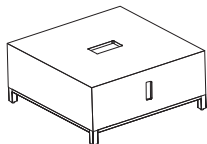
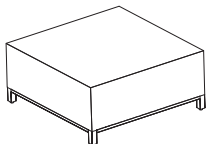
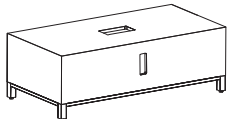
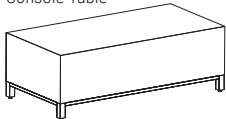

MODEL NO./DESCRIPTION	LIST PRICE	DIMENSIONS					CARTONED WEIGHT	CUBIC FEET
		D	W	H	A	KW		
WOOD								
91NB2424ENW End Table	\$ 1647	24	24	20½	–	–	55 lbs.	12.6
91NB1850CSW Console Table	2243	18	50	31½	–	–	75 lbs.	20.2
91NB2448MGW Magazine Table	1762	24	48	16½	–	–	77 lbs.	19.1
91NB3636MGW Coffee Table	1834	36	36	16½	–	–	65 lbs.	15.0
LAMINATE								
91NB2424ENL End Table	\$ 1378	24	24	20½	–	–	55 lbs.	12.6
91NB1850CSL Console Table	1980	18	50	31½	–	–	75 lbs.	20.2
91NB2448MGL Magazine Table	1497	24	48	16½	–	–	77 lbs.	19.1
91NB3636MGL Coffee Table	1565	36	36	16½	–	–	65 lbs.	15.0

- Optional glass and solid surface kits available; reference page 520
- Features an aluminum base in 3 color options
- Optional surface grommet cutout available in G12, G17, and G23 cutout (+\$25 list)
- Optional side grommet cutout available in G23 cutout (+\$25 list)
- Grommet option not available on console table
- Power grommet sold separately; reference pages 547-549, 554-557, and 560 for pricing and details
- Reference Myriad for detailed product information, finishes and entire Myriad offering starting on page 500

MYRIAD OCCASIONAL TABLES



TO ORDER, SPECIFY:

1. Model Number
2. Surface Grommet
3. Side Grommet (Cubes Only)
4. Finish/Laminate Color

SAMPLE MODEL NUMBERS:

91NA2424CYW X NM
91NA2424CUW X X MH

• See page 500 for all options available in Occasional Tables

MODEL NO./DESCRIPTION	LIST PRICE	DIMENSIONS					CARTONED WEIGHT	CUBIC FEET		
		D	W	H	A	KW				
MYRIAD CYLINDER		WOOD		DI		H				
 End Table	91NA2424CYW	End Table	\$ 1199	24	—	20½	—	—	35 lbs.	11.0
 Coffee Table	91NA3636MGYW	Coffee Table	1615	36½	—	16½	—	—	55 lbs.	18.6
LAMINATE										
	91NA2424CYL	End Table	\$ 740	24	—	20½	—	—	35 lbs.	11.0
	91NA3636MGYL	Coffee Table	1105	36½	—	16½	—	—	55 lbs.	18.6

• Optional glass and solid surface kits available; reference page 520
• Optional surface center grommet cutout available in G12, G17, and G23 cutout (+\$25 list)
• Power grommet sold separately; reference pages 547-549, 554-557, and 560 for pricing and details
• Reference Myriad for detailed product information, finishes and entire Myriad offering starting on page 500

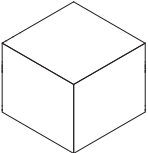
MODEL NO./DESCRIPTION	LIST PRICE	DIMENSIONS					CARTONED WEIGHT	CUBIC FEET					
		D	W	H	A	KW							
MYRIAD CUBE		WOOD		D		W		H		A		KW	
 End Table	91NA2424CUW	End Table	\$ 1199	24	24	20½	—	—	—	—	—	33 lbs.	11.1
	91NA2448MGTW	Magazine Table	1514	24	48	16½	—	—	—	—	—	66 lbs.	17.2
	91NA3636MGUW	Coffee Table	1514	36	36	16½	—	—	—	—	—	55 lbs.	18.9
LAMINATE													
	91NA2424CUL	End Table	\$ 740	24	24	20½	—	—	—	—	—	33 lbs.	11.1
	91NA2448MGTL	Magazine Table	1021	24	48	16½	—	—	—	—	—	66 lbs.	17.2
	91NA3636MGUL	Coffee Table	1021	36	36	16½	—	—	—	—	—	55 lbs.	18.9

• Optional glass and solid surface kits available; reference page 520
• Optional surface grommet cutout available in G12, G17, and G23 cutout (+\$25 list)
• Optional side grommet cutout available in G23 cutout (+\$25 list)
• Power grommet sold separately; reference pages 547-549, 554-557, and 560 for pricing and details
• Reference Myriad for detailed product information, finishes and entire Myriad offering starting on page 500

Optional Surface and Side Grommet Locations

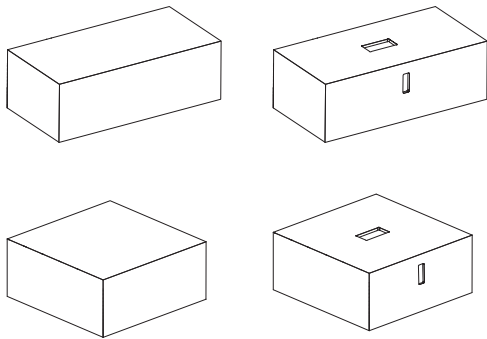

MYRIAD OCCASIONAL TABLES

TO ORDER, SPECIFY:

1. Model Number
2. Glass
3. Metal Color

SAMPLE MODEL NUMBER:

91NC2424ENG 3 462
 • See page 500 for all options available in Occasional Tables

MODEL NO./DESCRIPTION	LIST PRICE	DIMENSIONS					CARTONED WEIGHT	CUBIC FEET
		D	W	H	A	KW		
GLASS TOPS								
91NC2424ENG End Table	\$ 1959	24	24	20½	–	–	30 lbs.	2.2
91NC1850CSG Console Table	2536	18	50	28½	–	–	53 lbs.	5.2
91NC2448MGG Magazine Table	2277	24	48	16½	–	–	57 lbs.	5.5
91NC3636MGG Coffee Table	2277	36	36	16½	–	–	50 lbs.	3.5

MYRIAD FLOATING TOP

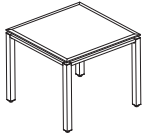

End Table

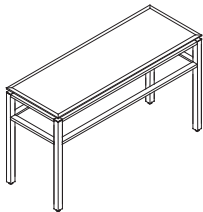

Console Table

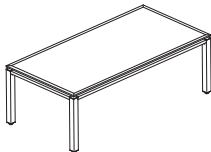

Magazine Table

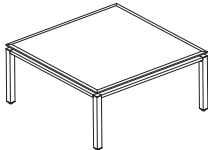

Coffee Table

- Some assembly required – glass must be attached to base
- Glass is clear with beveled rim
- Features an aluminum base
- Glass is ¾" thick
- Reference Myriad for detailed product information, finishes and entire Myriad offering starting on page 500

MYRIAD OCCASIONAL TABLES

TO ORDER, SPECIFY:

1. Model Number
2. Finish/Laminate Color
3. Metal Color

SAMPLE MODEL NUMBER:

91NC2424ENW MH 501

• See page 500 for all options available in Occasional Tables

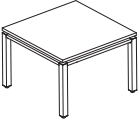
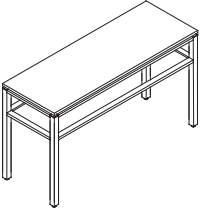
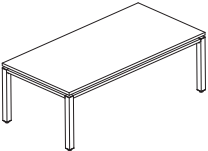
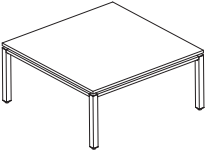
	MODEL NO./DESCRIPTION	LIST PRICE	DIMENSIONS					CARTONED WEIGHT	CUBIC FEET
			D	W	H	A	KW		
MYRIAD FLOATING TOP									
VENEER TOPS									
 End Table	91NC2424ENW	\$ 1616	24	24	20½	–	–	30 lbs.	2.2
	91NC1850CSW	2044	18	50	28½	–	–	53 lbs.	5.2
	91NC2448MGW	1834	24	48	16½	–	–	57 lbs.	5.5
	91NC3636MGW	1834	36	36	16½	–	–	50 lbs.	3.5
LAMINATE TOPS									
 Console Table	91NC2424ENL	\$ 1344	24	24	20½	–	–	30 lbs.	2.2
	91NC1850CSL	1780	18	50	28½	–	–	53 lbs.	5.2
	91NC2448MGL	1565	24	48	16½	–	–	57 lbs.	5.5
	91NC3636MGL	1565	36	36	16½	–	–	50 lbs.	3.5
<ul style="list-style-type: none"> • Floating top style with laminate tops are available in a CSL; reference page 18 for program details • Features an aluminum base in 4 color options • Grommet not available on floating top styles • Floating top is ¾" thick • Veneer tables feature matte/satin sheen • Reference Myriad for detailed product information, finishes and entire Myriad offering starting on page 500 									
 Magazine Table									
 Coffee Table									

RENO OCCASIONAL TABLES

TO ORDER, SPECIFY:

1. Model Number
2. Surface Grommet
3. Side Grommet (Square Only)
4. Paint
5. Finish/Laminate Color

SAMPLE MODEL NUMBER:

N32T24ENW X 462 MH

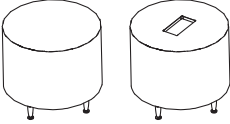
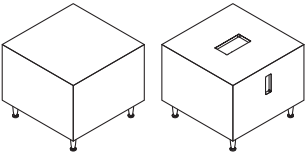
RENO END TABLE	MODEL NO./DESCRIPTION	LIST PRICE	DIMENSIONS					CARTONED CUBIC	
			D	W	H	A	KW	WEIGHT	FEET
 <p>Optional Surface Grommet Location</p>	ROUND		DI		H				
	N32T24ENW Wood	\$ 1594	24	—	20 ¹ / ₁₆	—	—	35 lbs.	11.0
	N32T24ENL Laminate	1342	24	—	20 ¹ / ₁₆	—	—	35 lbs.	11.0
	<ul style="list-style-type: none"> • Side grommet not available on round models • Optional surface grommet cutout available in G12, G17, and G23 cutout (+\$25 list) 								
 <p>Optional Surface and Side Grommet Locations</p>	SQUARE		D	W	H	A	KW		
	N32T2424ENW Wood	\$ 1594	24	24	20 ¹ / ₁₆	—	—	55 lbs.	12.6
	N32T2424ENL Laminate	1342	24	24	20 ¹ / ₁₆	—	—	55 lbs.	12.6
	<ul style="list-style-type: none"> • Optional surface grommet cutout available in G12, G17, and G23 cutout (+\$25 list) • Optional side grommet cutout on square table available in G23 cutout (+\$25 list) • Some assembly required; feet are field installed • Power grommet sold separately; reference pages 547-549, 554-557, and 560 for pricing and details • Optional glass and solid surface kits available; reference page 520 • Reference Reno for detailed product information, finishes and entire Reno offering starting on page 418 in the Seating Price List 								

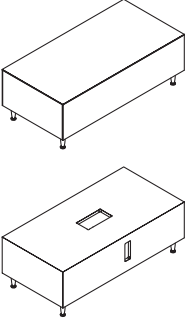
RENO MAGAZINE TABLE	MODEL NO./DESCRIPTION	LIST PRICE	D	W	H	A	KW	WEIGHT	CUBIC FEET
 <p>Optional Surface and Side Grommet Locations</p>	N32T2448MGW Wood	\$ 1709	24	48	16 ¹ / ₁₆	—	77	19.1 lbs.	
	N32T2448MGL Laminate	1464	24	48	16 ¹ / ₁₆	—	77	19.1 lbs.	
	<ul style="list-style-type: none"> • Optional surface grommet cutout available in G12, G17, and G23 cutout (+\$25 list) • Optional side grommet cutout available in G23 cutout (+\$25 list) • Some assembly required; feet are field installed • Power grommet sold separately; reference pages 547-549, 554-557, and 560 for pricing and details • Optional glass and solid surface kits available; reference page 520 • Reference Reno for detailed product information, finishes and entire Reno offering starting on page 418 in the Seating Price List 								

RENO OCCASIONAL TABLES

TO ORDER, SPECIFY:

1. Model Number
2. Surface Grommet
3. Side Grommet (Square Only)
4. Paint
5. Finish/Laminate Color

SAMPLE MODEL NUMBER:

N32T36MGW X 462 MH

RENO COFFEE TABLE	MODEL NO./DESCRIPTION	LIST PRICE	DIMENSIONS					CARTONED WEIGHT	CUBIC FEET
			D	W	H	A	KW		
	ROUND		DI		H				
	N32T36MGW Wood	\$ 1778	36 ¹ / ₁₆	—	16 ¹ / ₁₆	—	—	55 lbs.	18.6
	N32T36MGL Laminate	1534	36 ¹ / ₁₆	—	16 ¹ / ₁₆	—	—	55 lbs.	18.6

- Side grommet not available on round models
- Optional surface grommet cutout available in G12, G17, and G23 cutout (+\$25 list)

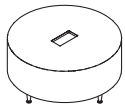
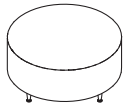

Optional Surface Grommet Location

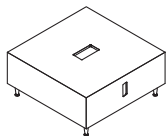
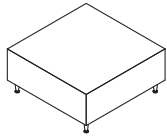

Optional Surface and Side Grommet Locations

RENO COFFEE TABLE	MODEL NO./DESCRIPTION	LIST PRICE	DIMENSIONS					CARTONED WEIGHT	CUBIC FEET
			D	W	H	A	KW		
	SQUARE								
	N32T3636MGW Wood	\$ 1778	36	36	16 ¹ / ₁₆	—	—	65 lbs.	15.0
	N32T3636MGL Laminate	1534	36	36	16 ¹ / ₁₆	—	—	65 lbs.	15.0

- Optional surface grommet cutout available in G12, G17, and G23 cutout (+\$25 list)
- Optional side grommet cutout available in G23 cutout (+\$25 list)

- Some assembly required; feet are field installed
- Power grommet sold separately; reference pages 547-549, 554-557, and 560 for pricing and details
- Optional glass and solid surface kits available; reference page 520
- Reference Reno for detailed product information, finishes and entire Reno offering starting on page 418 in the Seating Price List

ROOSEVELT OCCASIONAL TABLES



Shaded model numbers are available on our "To You in 10 Days or Less" Quick Delivery program and will be delivered in 10 days or less.

TO ORDER, SPECIFY:

1. Model Number
2. Finish/Laminate Color

SAMPLE MODEL NUMBER:

51N2040MGW MH

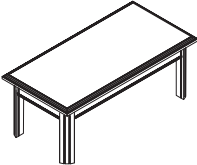
	MODEL NO./DESCRIPTION	LIST PRICE	DIMENSIONS					CARTONED CUBIC	
			D	W	H	A	KW	WEIGHT	FEET
ROOSEVELT MAGAZINE TABLE 	51N2040MGW Wood Top	\$ 1148	19 ³ / ₄	39 ³ / ₄	18 ³ / ₁₆	—	—	42 lbs.	3.0
	Q51N2040MGLW Laminate Top	987	19 ³ / ₄	39 ³ / ₄	18 ³ / ₁₆	—	—	42 lbs.	3.0
	51N2040MGLW Laminate Top	987	19 ³ / ₄	39 ³ / ₄	18 ³ / ₁₆	—	—	42 lbs.	3.0

- Some assembly required
- Laminate top tables have veneer legs/base
- Reference Roosevelt for detailed product information, finishes and entire Roosevelt offering starting on page 160 in the Casegoods Book 1 Price List

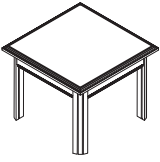
	MODEL NO./DESCRIPTION	LIST PRICE	DIMENSIONS					CARTONED CUBIC	
			D	W	H	A	KW	WEIGHT	FEET
ROOSEVELT END TABLE 	51N2424ENW Wood Top	\$ 987	23 ³ / ₄	23 ³ / ₄	22 ³ / ₁₆	—	—	38 lbs.	2.8
	Q51N2424ENLW Laminate Top	878	23 ³ / ₄	23 ³ / ₄	22 ³ / ₁₆	—	—	38 lbs.	2.8
	51N2424ENLW Laminate Top	878	23 ³ / ₄	23 ³ / ₄	22 ³ / ₁₆	—	—	38 lbs.	2.8

- Some assembly required
- Laminate top tables have veneer legs/base
- Reference Roosevelt for detailed product information, finishes and entire Roosevelt offering starting on page 160 in the Casegoods Book 1 Price List

STACCATO OCCASIONAL TABLES

ROUND TABLE SIZES

End Table 24" Diameter
 Coffee Table 36" Diameter
 Counter Height 24" and 36" Diameter
 Bar Height 24" and 36" Diameter

SOFT SQUARE TABLE SIZES

End Table 24" x 24"
 Coffee Table 36" x 36"
 Counter Height 24" x 24" and 36" x 36"
 Bar Height 24" x 24" and 36" x 36"

GLASS TOP KITS AVAILABLE FOR

Round
 Soft Square

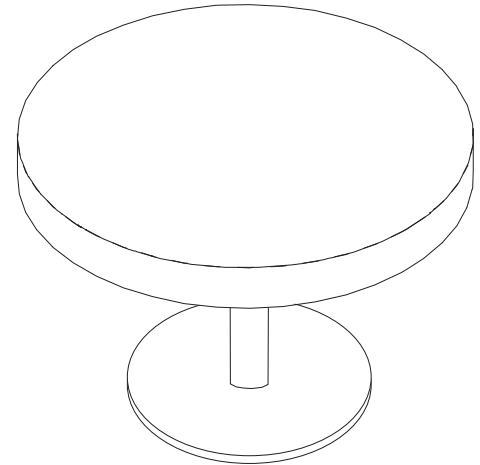

WOOD FINISHES

AC Autumn
 CL Caramel
 CW Cordovan
 DW Judicial
 HN Honey
 IM Brighton
 MC Amber
 MH Mocha
 NM Natural
 TF Truffle

- Veneer tables are plain sliced slipmatched cherry (Amber, Autumn, Mocha, Truffle), maple veneer (Brighton, Caramel, Honey, Natural), or plain sliced bookmatched walnut veneer (Cordovan, Judicial)

LAMINATES

WOODGRAIN LAMINATE

AC2 Autumn 2
 AD Almond
 CL Caramel
 CW Cordovan
 DW Judicial
 HN2 Honey 2
 IM Brighton
 MC Amber
 MH Mocha
 NM Natural
 PB Portobello
 PT Portico
 SK Skyline
 SM Sonoma
 TF Truffle
 792 Sable
 793 Acorn

SOLID LAMINATE

405 Designer White
 419 Wallaby
 425 Shadow
 440 Cloud
 461 Graphite
 462 Cinder
 478 Platinum Grey
 488 Frosty White
 491 Designer White Linear
 492 Cinder Linear

PATTERN LAMINATE

814 White Tigris
 818 Crisp Linen
 819 Flax Gauze
 821 Elemental Concrete
 822 Smoke Quarstone
 874 Bronze Legacy

FINISH APPLICATION

- All Veneer surfaces feature a semi-open pore matte finish

COLUMN PAINT COLOR

405 Designer White
 423 Concrete
 462 Cinder
 463 Iron
 501 Platinum Metallic
 503 Satin Nickel Metallic

FOOT PAINT COLOR

405 Designer White
 423 Concrete
 462 Cinder
 463 Iron
 501 Platinum Metallic
 503 Satin Nickel Metallic

DIMENSION KEY

D Depth
 W Width
 H Height
 A Overhang: Approach Side
 KW Kneespace Width
 DI Diameter

STACCATO OCCASIONAL TABLES

TO ORDER, SPECIFY:

1. Model Number
2. Finish/Laminate Color
3. Column Paint Color
4. Foot Paint Color

SAMPLE MODEL NUMBER:

82N3636MGRDW MH 462 405

- See page 508 for all options available in Occasional Tables

MODEL NO./DESCRIPTION	LIST PRICE	DIMENSIONS					CARTONED WEIGHT	CUBIC FEET
		D	W	H	A	KW		
STACCATO COFFEE TABLE		ROUND		DI	H			
82N3636MGRDW	Wood	\$ 2277	36 ¹ / ₁₆	—	17 ¹ / ₁₆	—	—	97 lbs. 9.6
82N3636MGRDL	Laminate	1987	36 ¹ / ₁₆	—	17 ¹ / ₁₆	—	—	97 lbs. 9.6
		SOFT SQUARE		D	W	H	A	KW
82N3636MGSQW	Wood	\$ 2411	36	36	17 ¹ / ₁₆	—	—	97 lbs. 9.6
82N3636MGSQL	Laminate	2120	36	36	17 ¹ / ₁₆	—	—	97 lbs. 9.6

- Some assembly required
- No grommet cutouts available
- Optional glass and solid surface kits available; reference page 520
- 3" column base
- Glide adjustment of +/- 1/8"
- 4 1/8" height top
- Column available in paint colors (405) Designer White, (423) Concrete, (462) Cinder, (463) Iron, (501) Platinum Metallic, or (503) Satin Nickel Metallic
- Foot available in paint colors (405) Designer White, (423) Concrete, (462) Cinder, (463) Iron, (501) Platinum Metallic, or (503) Satin Nickel Metallic
- Reference Staccato for detailed product information, finishes and entire Staccato offering starting on page 508

MODEL NO./DESCRIPTION	LIST PRICE	DIMENSIONS					CARTONED WEIGHT	CUBIC FEET
		D	W	H	A	KW		
STACCATO END TABLE		ROUND		DI	H			
82N2424MGRDW	Wood	\$ 1959	23 ³ / ₁₆	—	20 ¹ / ₁₆	—	—	64 lbs. 7.3
82N2424MGRDL	Laminate	1667	23 ³ / ₁₆	—	20 ¹ / ₁₆	—	—	64 lbs. 7.3
		SOFT SQUARE		D	W	H	A	KW
82N2424MGSQW	Wood	\$ 2094	24	24	20 ¹ / ₁₆	—	—	64 lbs. 7.3
82N2424MGSQL	Laminate	1800	24	24	20 ¹ / ₁₆	—	—	64 lbs. 7.3

- Some assembly required
- No grommet cutouts available
- Optional glass and solid surface kits available; reference page 520
- 3" column base
- Glide adjustment of +/- 1/8"
- 4 1/8" height top
- Column available in paint colors (405) Designer White, (423) Concrete, (462) Cinder, (463) Iron, (501) Platinum Metallic, or (503) Satin Nickel Metallic
- Foot available in paint colors (405) Designer White, (423) Concrete, (462) Cinder, (463) Iron, (501) Platinum Metallic, or (503) Satin Nickel Metallic
- Reference Staccato for detailed product information, finishes and entire Staccato offering starting on page 508

STACCATO OCCASIONAL TABLES

TO ORDER, SPECIFY:

1. Model Number
2. Finish/Laminate Color
3. Column Paint Color
4. Foot Paint Color

SAMPLE MODEL NUMBER:

82N363635RDTW MH 462 405

- See page 508 for all options available in Occasional Tables

MODEL NO./DESCRIPTION	LIST PRICE	DIMENSIONS					CARTONED WEIGHT	CUBIC FEET
		D	W	H	A	KW		
STACCATO COUNTER HEIGHT TABLE		ROUND		DI	H			
82N363635RDTW	Wood \$ 2398	36 ¹ / ₁₆	—	35 ⁷ / ₁₆	—	—	112 lbs.	11.1
82N363635RDTL	Laminate 2106	36 ¹ / ₁₆	—	35 ⁷ / ₁₆	—	—	112 lbs.	11.1
82N242435RDTW	Wood \$ 2246	23 ³ / ₈	—	35 ⁷ / ₁₆	—	—	80 lbs.	8.8
82N242435RDTL	Laminate 1955	23 ³ / ₈	—	35 ⁷ / ₁₆	—	—	80 lbs.	8.8
SOFT SQUARE		D	W	H	A	KW		
82N363635SQTW	Wood \$ 2533	36	36	35 ⁷ / ₁₆	—	—	112 lbs.	11.1
82N363635SQTL	Laminate 2241	36	36	35 ⁷ / ₁₆	—	—	112 lbs.	11.1
82N242435SQTW	Wood \$ 2380	24	24	35 ⁷ / ₁₆	—	—	80 lbs.	8.8
82N242435SQTL	Laminate 2087	24	24	35 ⁷ / ₁₆	—	—	80 lbs.	8.8

- Some assembly required
- No grommet cutouts available
- Optional glass and solid surface kits available; reference page 520
- 3" column base
- Glide adjustment of +/- 1/8"
- 4 1/8" height top
- Column available in paint colors (405) Designer White, (423) Concrete, (462) Cinder, (463) Iron, (501) Platinum Metallic, or (503) Satin Nickel Metallic
- Foot available in paint colors (405) Designer White, (423) Concrete, (462) Cinder, (463) Iron, (501) Platinum Metallic, or (503) Satin Nickel Metallic
- Reference Staccato for detailed product information, finishes and entire Staccato offering starting on page 508

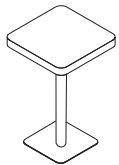
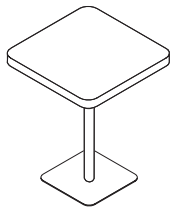
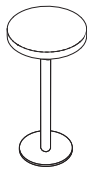
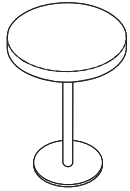

STACCATO OCCASIONAL TABLES

TO ORDER, SPECIFY:

1. Model Number
2. Finish/Laminate Color
3. Column Paint Color
4. Foot Paint Color

SAMPLE MODEL NUMBER:

82N363640RDTW MH 462 405

- See page 508 for all options available in Occasional Tables

MODEL NO./DESCRIPTION	LIST PRICE	DIMENSIONS					CARTONED WEIGHT	CUBIC FEET	
		D	W	H	A	KW			
ROUND		DI	H						
82N363640RDTW Wood	\$ 2463	36 ¹ / ₁₆	—	41 ¹ / ₁₆	—	—	112 lbs.	11.5	
82N363640RDTL Laminate	2174	36 ¹ / ₁₆	—	41 ¹ / ₁₆	—	—	112 lbs.	11.5	
SOFT SQUARE		D	W	H	A	KW			
82N363640SQTW Wood	\$ 2596	36	36	41 ¹ / ₁₆	—	—	112 lbs.	11.5	
82N363640SQTL Laminate	2304	36	36	41 ¹ / ₁₆	—	—	112 lbs.	11.5	
82N242440SQTW Wood	\$ 2445	24	24	41 ¹ / ₁₆	—	—	80 lbs.	9.2	
82N242440SQTL Laminate	2154	24	24	41 ¹ / ₁₆	—	—	80 lbs.	9.2	

STACCATO BAR HEIGHT TABLE

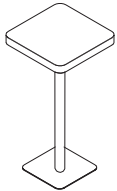
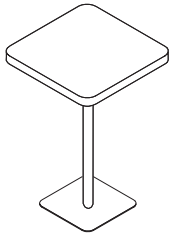
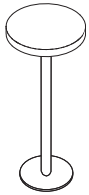
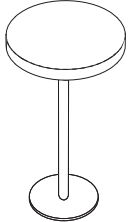

- Some assembly required
- No grommet cutouts available
- Optional glass and solid surface kits available; reference page 520
- 3" column base
- Glide adjustment of +/- 1/8"
- 4 1/8" height top
- Column available in paint colors (405) Designer White, (423) Concrete, (462) Cinder, (463) Iron, (501) Platinum Metallic, or (503) Satin Nickel Metallic
- Foot available in paint colors (405) Designer White, (423) Concrete, (462) Cinder, (463) Iron, (501) Platinum Metallic, or (503) Satin Nickel Metallic
- Reference Staccato for detailed product information, finishes and entire Staccato offering starting on page 508

SWIFT OCCASIONAL TABLES

TO ORDER, SPECIFY:

1. Model Number
2. Surface Grommet
3. Side Grommet
4. Finish/Laminate Color
5. Frame Color

SAMPLE MODEL NUMBERS:

N95PPW X X CL 497
 N95PPL X X MC 501

	MODEL NO./DESCRIPTION	LIST PRICE	DIMENSIONS					CARTONED CUBIC	
			D	W	H	A	KW	WEIGHT	FEET
SWIFT SMALL END TABLE	N95PPW Wood	\$ 1458	28	14	16½	—	—	31.8 lbs.	7.5
	N95PPL Laminate	1353	28	14	16½	—	—	31.8 lbs.	7.5

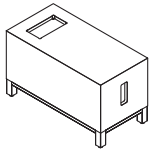
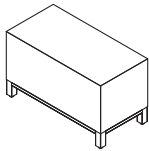

Optional Surface and Side Grommet Locations

- Power grommet sold separately; reference pages 547-549, 554-557, and 560 for pricing and details
- Optional surface grommet cutout available in G12, G17, and G23 cutout (+\$25 list)
- Optional side grommet cutout available in G23 cutout (+\$25 list)
- Reference Swift for detailed product information, finishes and entire Swift offering starting on page 448 in the Seating Price List

SWIFT COFFEE TABLE	N95RRW Wood	\$ 2277	36	36	13¾	—	—	70 lbs.	16.8
	N95RRL Laminate	2174	36	36	13¾	—	—	70 lbs.	16.8

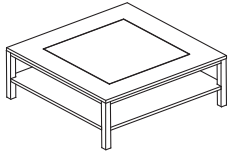

- Power grommet option not available
- Frosted ⅜" thick tempered glass insert
- Reference Swift for detailed product information, finishes and entire Swift offering starting on page 448 in the Seating Price List

SWIFT CONSOLE TABLE	N95SSW Wood	\$ 2434	18	50	33½	—	—	74.2 lbs.	26.4
	N95SSL Laminate	2328	18	50	33½	—	—	74.2 lbs.	26.4

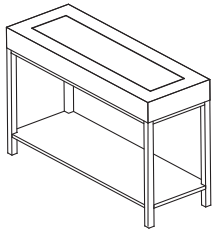

- Power grommet option not available
- Frosted ⅜" thick tempered glass insert
- Reference Swift for detailed product information, finishes and entire Swift offering starting on page 448 in the Seating Price List

SWIFT OCCASIONAL TABLES

TO ORDER, SPECIFY:

1. Model Number
2. Surface Grommet
3. Side Grommet
4. Finish/Laminate Color
5. Frame Color

SAMPLE MODEL NUMBERS:

N95KKW X X CW 462
 N95KKL X X 462 501

MODEL NO./DESCRIPTION	LIST PRICE	DIMENSIONS				CARTONED CUBIC	
		D	W	H	A	KW	WEIGHT FEET
SWIFT 30° TABLE							
N95KKW Wood	\$ 1744	30¾	25	16½	—	—	40 lbs. 12.6
N95KKL Laminate	1637	30¾	25	16½	—	—	40 lbs. 12.6

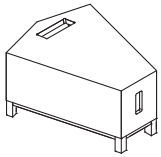
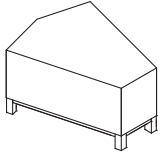

Optional Surface and Side Grommet Locations

- Power grommet sold separately; reference pages 547-549, 554-557, and 560 for pricing and details
- Optional surface grommet cutout available in G12, G17, and G23 cutout (+\$25 list)
- Optional side grommet cutout available in G23 cutout (+\$25 list)
- Reference Swift for detailed product information, finishes and entire Swift offering starting on page 448 in the Seating Price List

SWIFT 45° TABLE							
N95LLW Wood	\$ 1887	32¾	31½	16½	—	—	45.2 lbs. 16.3
N95LLL Laminate	1780	32¾	31½	16½	—	—	45.2 lbs. 16.3

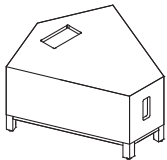
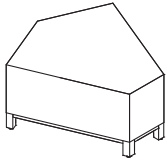

Optional Surface and Side Grommet Locations

- Power grommet sold separately; reference pages 547-549, 554-557, and 560 for pricing and details
- Optional surface grommet cutout available in G12, G17, and G23 cutout (+\$25 list)
- Optional side grommet cutout available in G23 cutout (+\$25 list)
- Reference Swift for detailed product information, finishes and entire Swift offering starting on page 448 in the Seating Price List

SWIFT 90° TABLE							
N95NNW Wood	\$ 1958	28	28	16½	—	—	47.8 lbs. 13.1
N95NNL Laminate	1852	28	28	16½	—	—	47.8 lbs. 13.1

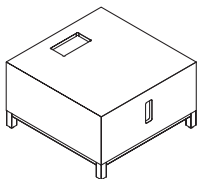
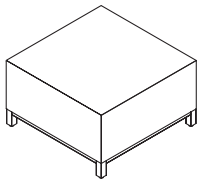

Optional Surface and Side Grommet Locations

- Power grommet sold separately; reference pages 547-549, 554-557, and 560 for pricing and details
- Optional surface grommet cutout available in G12, G17, and G23 cutout (+\$25 list)
- Optional side grommet cutout available in G23 cutout (+\$25 list)
- Reference Swift for detailed product information, finishes and entire Swift offering starting on page 448 in the Seating Price List

TAG OCCASIONAL TABLES

TO ORDER, SPECIFY:

1. Model Number
2. Finish/Laminate Color
3. Frame Color

SAMPLE MODEL NUMBER:

N60SGW MC 462

	MODEL NO./DESCRIPTION	LIST PRICE	DIMENSIONS					CARTONED CUBIC	
			D	W	H	A	KW	WEIGHT	FEET
TAG END TABLE	N60SGW Wood Top	\$ 651	18	20	17 $\frac{3}{4}$	—	—	15 lbs.	6.1
	N60SGL Laminate Top	548	18	20	17 $\frac{3}{4}$	—	—	15 lbs.	6.1

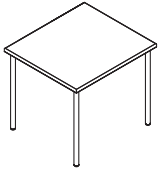

- Platinum Metallic option available for a \$42 list upcharge
- Reference Tag for detailed product information, finishes and entire Tag offering starting on page 474 in the Seating Price List

TAG CORNER TABLE	N60SHW Wood Top	\$ 918	28	28	17 $\frac{3}{4}$	—	—	24 lbs.	11.5
	N60SHL Laminate Top	816	28	28	17 $\frac{3}{4}$	—	—	24 lbs.	11.5



- Platinum Metallic option available for a \$42 list upcharge
- Reference Tag for detailed product information, finishes and entire Tag offering starting on page 474 in the Seating Price List

TAG MAGAZINE TABLE	N60SKW Wood Top	\$ 890	19 $\frac{1}{2}$	39 $\frac{1}{2}$	16	—	—	24 lbs.	10.7
	N60SKL Laminate Top	788	19 $\frac{1}{2}$	39 $\frac{1}{2}$	16	—	—	24 lbs.	10.7

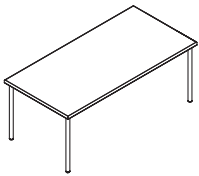

- Platinum Metallic option available for a \$42 list upcharge
- Reference Tag for detailed product information, finishes and entire Tag offering starting on page 474 in the Seating Price List

TESSERA OCCASIONAL TABLES

TO ORDER, SPECIFY:

1. Model Number
2. Leg Color
3. Finish/Laminate Color

SAMPLE MODEL NUMBERS:

- | | | |
|-------------|-----|----|
| 59N24ENRDW | 501 | MH |
| 59N24ENRDLW | 501 | MH |

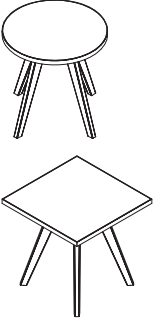
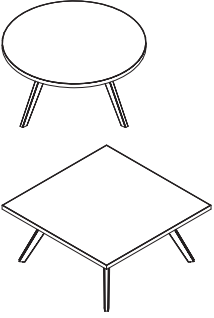
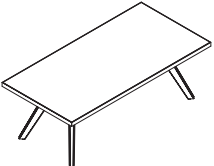
	MODEL NO./DESCRIPTION	LIST PRICE	DIMENSIONS				CARTONED CUBIC			
			D	W	H	A	KW	WEIGHT	FEET	
TESSERA END TABLE										
	ROUND									
	59N24ENRDW	Wood	\$ 1829	24	24	23 $\frac{3}{4}$	—	—	83 lbs.	14.2
	59N24ENRDLW	Laminate	1557	24	24	23 $\frac{3}{4}$	—	—	83 lbs.	14.2
	SQUARE									
	59N2424ENSQW	Wood	\$ 1954	24	24	23 $\frac{3}{4}$	—	—	55 lbs.	14.2
	59N2424ENSQW	Laminate	1681	24	24	23 $\frac{3}{4}$	—	—	55 lbs.	14.2
	<ul style="list-style-type: none"> • No grommet cutouts available • 1$\frac{1}{8}$" thick top • Reference Tessera for detailed product information, finishes and entire Tessera offering starting on page 172 in the Casegoods Book 1 Price List 									
TESSERA COFFEE TABLE										
	ROUND									
	59N36MGRDW	Wood	\$ 2127	36 $\frac{3}{8}$	36 $\frac{3}{8}$	16 $\frac{3}{4}$	—	—	55 lbs.	21.6
	59N36MGRDLW	Laminate	1854	36 $\frac{3}{8}$	36 $\frac{3}{8}$	16 $\frac{3}{4}$	—	—	55 lbs.	21.6
	SQUARE									
	59N3636MGSQW	Wood	\$ 2250	36 $\frac{3}{8}$	36 $\frac{3}{8}$	16 $\frac{3}{4}$	—	—	65 lbs.	21.6
	59N3636MGSQW	Laminate	1978	36 $\frac{3}{8}$	36 $\frac{3}{8}$	16 $\frac{3}{4}$	—	—	65 lbs.	21.6
	<ul style="list-style-type: none"> • No grommet cutouts available • 1$\frac{1}{8}$" thick top • Reference Tessera for detailed product information, finishes and entire Tessera offering starting on page 172 in the Casegoods Book 1 Price List 									
TESSERA MAGAZINE TABLE										
	59N2448MGW	Wood	\$ 2127	24	48	16 $\frac{3}{4}$	—	—	77 lbs.	19.7
	59N2448MGLW	Laminate	1854	24	48	16 $\frac{3}{4}$	—	—	77 lbs.	19.7
	<ul style="list-style-type: none"> • No grommet cutouts available • 1$\frac{1}{8}$" thick top • Reference Tessera for detailed product information, finishes and entire Tessera offering starting on page 172 in the Casegoods Book 1 Price List 									

UNIVERSAL OCCASIONAL TABLES

SOLID SURFACE TOP OPTIONS

COLORS

- 7101 Bisque (Grade A)
- 7201 Glacier White (Grade A)
- 7202 Canyon (Grade B)
- 7203 Designer White (Grade B)
- 7204 Silt (Grade B)
- 7301 Concrete (Grade C)
- 7302 Deep Night Sky (Grade C)
- 7303 Deep Nocturne (Grade C)

RIM PROFILE

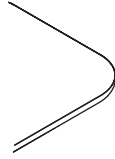

COLUMN PAINT COLOR

- 265 Polished
- 405 Designer White
- 423 Concrete
- 462 Cinder
- 463 Iron
- 501 Platinum Metallic
- 503 Satin Nickel Metallic

BASE PAINT COLOR

- 405 Designer White
- 423 Concrete
- 462 Cinder
- 463 Iron
- 501 Platinum Metallic
- 503 Satin Nickel Metallic

WOOD FINISH

- AC Autumn
- AD Almond
- CL Caramel
- CW Cordovan
- DW Judicial
- HN Honey
- IM Brighton
- MC Amber
- MH Mocha
- NM Natural
- PB Portobello
- PT Portico
- SK Skyline
- SM Sonoma
- TF Truffle
- 405 Designer White
- 462 Cinder
- 792 Sable
- 793 Acorn

Acorn is the wood complement to Clear Walnut finish

WOODGRAIN LAMINATE

- AC2 Autumn 2
- AD Almond
- BZ Brazilwood
- CI Chai
- CL Caramel
- CW Cordovan
- DW Judicial
- HN2 Honey 2
- IM Brighton
- KN Kona
- MC Amber
- MH Mocha
- NM Natural
- PB Portobello
- PC Porcini
- PT Portico
- SK Skyline
- SM Sonoma
- TF Truffle
- WL Willow
- 792 Sable
- 793 Acorn*

*Acorn is the laminate complement to Clear Walnut finish

SOLID LAMINATE

- 405 Designer White
- 419 Wallaby
- 425 Shadow
- 440 Cloud
- 457 Dapple
- 461 Graphite
- 462 Cinder
- 478 Platinum Grey
- 488 Frosty White
- 491 Designer White Linear
- 492 Cinder Linear

GALLERY LAMINATE

- Grade 1 – 5% upcharge
- G1001 Citadel
- G1011 Pepperdust
- Grade 2 – 6% upcharge
- G1002 Planked Raw Oak
- G1003 Evening Notte
- G1004 Kirsche
- G1005 Midnight Run
- G1006 Sepia Walnut
- G1007 Serotina
- G1008 Timeless
- G1009 White Nebbia
- G1012 Phantom Ecrú

See page 18 for Gallery program details and upcharges

UNIVERSAL OCCASIONAL TABLES

TO ORDER, SPECIFY:



1. Model Number

SAMPLE MODEL NUMBER:

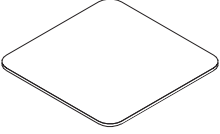
10N3636RDBPG

	MODEL NO./DESCRIPTION	LIST PRICE	DIMENSIONS					CARTONED WEIGHT	CUBIC FEET	
			D	W	H	A	KW			
UNIVERSAL GLASS TOP  	ROUND		DI		H					
	10N3636RDBPG	White Back Painted Glass	\$ 2293	36 $\frac{3}{8}$	—	1 $\frac{1}{2}$	—	—	65 lbs.	4.7
	10N2424RDBPG	White Back Painted Glass	1678	23 $\frac{3}{8}$	—	1 $\frac{1}{2}$	—	—	31 lbs.	1.9
	SOFT SQUARE			D	W	H	A	KW		
	10N3636SQBPG	White Back Painted Glass	\$ 2293	35 $\frac{3}{8}$	35 $\frac{3}{8}$	1 $\frac{1}{2}$	—	—	69 lbs.	4.7
	10N2424SQBPG	White Back Painted Glass	1678	23 $\frac{3}{8}$	23 $\frac{3}{8}$	1 $\frac{1}{2}$	—	—	28 lbs.	1.9

- 24" top for use with 22" disc or soft square base on pages 518-520
- 36" top for use with 27" disc or soft square base on pages 518-520
- 1 $\frac{1}{2}$ " thickness includes the glass and substrate
- Features writable surface
- Footings Bases cannot be used with the Universal glass tops due to the size of the mounting brackets

	ROUND	GRADE A	GRADE B	GRADE C	DI	H						
						D	W	H	A	KW		
UNIVERSAL SOLID SURFACE TOP  												
	10N36RDS	Solid Surface	\$ 2850	\$ 3111	\$ 3453	36	—	1 $\frac{1}{2}$	—	—	59 lbs.	2.7
	10N24RDS	Solid Surface	1790	1906	2058	24	—	1 $\frac{1}{2}$	—	—	26 lbs.	1.3
	SOFT SQUARE					D	W	H	A	KW		
	10N3636SSQS	Solid Surface	\$ 2850	\$ 3111	\$ 3453	36	36	1 $\frac{1}{2}$	—	—	79 lbs.	2.7
	10N2424SSQS	Solid Surface	1790	1906	2058	24	24	1 $\frac{1}{2}$	—	—	38 lbs.	1.3

- Grommet cutout not available on solid surface tops
- Not intended for use with adjustable height bases
- 24" top for use with 22" disc or soft square base on pages 518-520
- 36" top for use with 27" disc or soft square base on pages 518-520

UNIVERSAL OCCASIONAL TABLES



Shaded model numbers are available on our "To You in 10 Days or Less" Quick Delivery program and will be delivered in 10 days or less.

TO ORDER, SPECIFY:

1. Model Number
2. Column Paint Color
3. Base Paint Color

SAMPLE MODEL NUMBER:

CBV2715DRNBP 265 462

	MODEL NO./DESCRIPTION	LIST PRICE	DIMENSIONS				CARTONED CUBIC		
			D	W	H	A	KW	WEIGHT	FEET
DISC BASE OCCASIONAL TABLE HEIGHT	CBV2715DRNBP	\$ 812	3	27 ³ / ₁₆	16	—	—	60 lbs.	1.9
	CBV2215DRNBP	613	3	22	16	—	—	43 lbs.	1.9

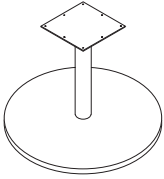

- 3" column base
- Some assembly required
- Reference Base Requirements Chart on pages 643-644 in the Casegoods Book 2 Price List
- Glide adjustment of +/- 1/8"

SOFT SQUARE BASE OCCASIONAL TABLE HEIGHT	CBV2715DSQBP	\$ 945	3	27 ³ / ₁₆	16	—	—	60 lbs.	1.9
	CBV2215DSQBP	744	3	22	16	—	—	50 lbs.	1.9

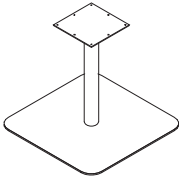

- 3" column base
- Some assembly required
- Reference Base Requirements Chart on pages 643-644 in the Casegoods Book 2 Price List
- Glide adjustment of +/- 1/8"

DISC BASE WORKSURFACE HEIGHT	CBV2728DRNBP	\$ 864	3	27 ³ / ₁₆	27 ³ / ₁₆	—	—	73 lbs.	2.8
	CBV2228DRNBP	647	3	22	27 ³ / ₁₆	—	—	56 lbs.	2.8

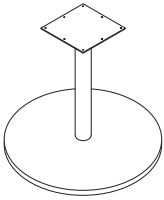

- 3" column base
- Some assembly required
- Reference Base Requirements Chart on pages 643-644 in the Casegoods Book 2 Price List
- Glide adjustment of +/- 1/8"

SOFT SQUARE BASE WORKSURFACE HEIGHT	CBV2728DSQBP	\$ 999	3	27 ³ / ₁₆	27 ³ / ₁₆	—	—	84 lbs.	2.8
	QCBV2228DSQBP	779	3	22	27 ³ / ₁₆	—	—	63 lbs.	2.8
	CBV2228DSQBP	779	3	22	27 ³ / ₁₆	—	—	63 lbs.	2.8

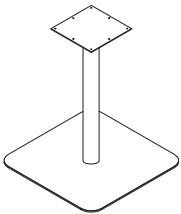

- 3" column base
- Some assembly required
- Reference Base Requirements Chart on pages 643-644 in the Casegoods Book 2 Price List
- Glide adjustment of +/- 1/8"

UNIVERSAL OCCASIONAL TABLES

TO ORDER, SPECIFY:

1. Model Number
2. Column Paint Color
3. Base Paint Color

SAMPLE MODEL NUMBER:

CBV2740DRNBP 265 462

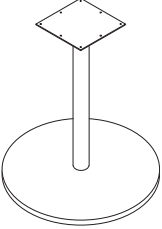
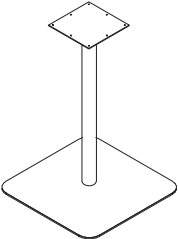
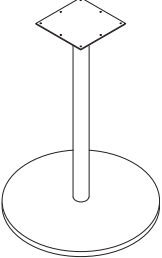
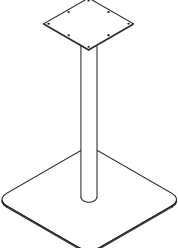
	MODEL NO./DESCRIPTION	LIST PRICE	DIMENSIONS			A	KW	CARTONED WEIGHT	CUBIC FEET
			D	W	H				
DISC BASE COUNTER HEIGHT	CBV2735DRNBP	\$ 933	3	27 ³ / ₁₆	35	—	—	75 lbs.	3.4
	CBV2235DRNBP	900	3	22	35	—	—	58 lbs.	3.4
	<ul style="list-style-type: none"> • 3" column base • Some assembly required • Reference Base Requirements Chart on pages 643-644 in the Casegoods Book 2 Price List • Glide adjustment of +/- 1/8" 								
SOFT SQUARE BASE COUNTER HEIGHT	CBV2735DSQBP	\$ 1067	3	27 ³ / ₁₆	35	—	—	86 lbs.	3.4
	CBV2235DSQBP	1032	3	22	35	—	—	65 lbs.	3.4
	<ul style="list-style-type: none"> • 3" column base • Some assembly required • Reference Base Requirements Chart on pages 643-644 in the Casegoods Book 2 Price List • Glide adjustment of +/- 1/8" 								
DISC BASE BAR HEIGHT	CBV2740DRNBP	\$ 999	3	27 ³ / ₁₆	40 ³ / ₄	—	—	76 lbs.	3.8
	CBV2240DRNBP	964	3	22	40 ³ / ₄	—	—	59 lbs.	3.8
	<ul style="list-style-type: none"> • 3" column base • Some assembly required • Reference Base Requirements Chart on pages 643-644 in the Casegoods Book 2 Price List • Glide adjustment of +/- 1/8" 								
SOFT SQUARE BASE BAR HEIGHT	CBV2740DSQBP	\$ 1130	3	27 ³ / ₁₆	40 ³ / ₄	—	—	87 lbs.	3.8
	CBV2240DSQBP	1097	3	22	40 ³ / ₄	—	—	66 lbs.	3.8
	<ul style="list-style-type: none"> • 3" column base • Some assembly required • Reference Base Requirements Chart on pages 643-644 in the Casegoods Book 2 Price List • Glide adjustment of +/- 1/8" 								

UNIVERSAL OCCASIONAL TABLES

TO ORDER, SPECIFY:

1. Model Number
2. Solid Surface Grade
3. Solid Surface Color

SAMPLE MODEL NUMBER:

10N2424SQSK A 7101

MODEL NO./DESCRIPTION	LIST PRICE	DIMENSIONS					CARTONED WEIGHT	CUBIC FEET	
		D	W	H	A	KW			
UNIVERSAL SOLID SURFACE KITS									
SQUARE/RECTANGULAR		GRADE A	GRADE B	GRADE C					
10N2424SQSK End Table Kit	\$ 1302	\$ 1418	\$ 1570	24	24	¾	—	25 lbs.	1.05
10N2448RTSK Magazine Table Kit	1917	2149	2453	24	48	¾	—	47 lbs.	2.0
10N3636SQSK Coffee Table Kit	1917	2178	2520	36	36	¾	—	52 lbs.	2.2
10N1850RTSK Console Table Kit	1917	2098	2336	18	50	¾	—	38 lbs.	1.6
SOFT SQUARE									
10N2424SSQSK End Table Kit	\$ 1282	\$ 1398	\$ 1550	24	24	¾	—	25 lbs.	1.1
10N3636SSQSK Coffee Table Kit	1987	2248	2590	36	36	¾	—	52 lbs.	2.2
ROUND									
10N2424RDSK End Table Kit	\$ 1282	\$ 1398	\$ 1550	24	—	¾	—	23 lbs.	1.1
10N3636RDSK Coffee Table Kit	1987	2248	2590	36	—	¾	—	49 lbs.	2.2

- For use on box, cylinder, soft square and cube styles on pages 492, 501-502, and 509-511
- When pairing a solid surface kit with another occasional table, the solid surface top may be sized smaller than the occasional table

UNIVERSAL GLASS KITS

MODEL NO./DESCRIPTION	LIST PRICE	DIMENSIONS					CARTONED WEIGHT	CUBIC FEET
		D	W	H	A	KW		
SQUARE/RECTANGULAR								
10N2424SQGK End Table Kit	\$ 713	24	24	¾	—	—	55 lbs.	12.6
10N2448RTGK Magazine Table Kit	999	24	48	¾	—	—	77 lbs.	19.1
10N3636SQGK Coffee Table Kit	999	36	36	¾	—	—	75 lbs.	20.2
10N1850RTGK Console Table Kit	999	18	50	¾	—	—	65 lbs.	15.0
SOFT SQUARE								
10N2424SSQGK End Table Kit	\$ 999	24	—	24	—	—	22 lbs.	1.0
10N3636SSQGK Coffee Table Kit	1497	24	—	36	—	—	49 lbs.	2.1
ROUND								
10N2424RDGK End Table Kit	\$ 999	24	—	¾	—	—	18 lbs.	1.0
10N3636RDGK Coffee Table Kit	1497	36	—	¾	—	—	37 lbs.	2.1

- For use on box, cylinder, soft square and cube styles on pages 492, 501-502, and 509-511
- Specify model number only
- Glass is clear with beveled rim
- Glass comes with stanchions for easy attachment to table
- Square kits feature square stanchions and soft square/round kits feature round stanchions

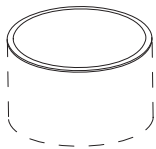
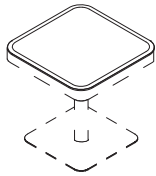
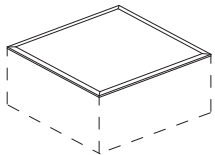
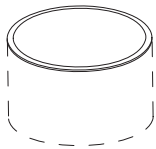
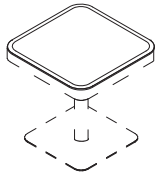
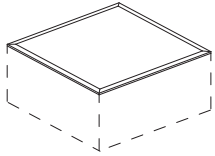

UNIVERSAL OCCASIONAL TABLES

TO ORDER, SPECIFY:

1. Model Number
2. Laminate Color
3. Paint

SAMPLE MODEL NUMBER:

10N1622RTPUW 419 462

	MODEL NO./DESCRIPTION		LIST PRICE	DIMENSIONS					CARTONED CUBIC	
				D	W	H	A	KW	WEIGHT	FEET
PERSONAL PULL-UP TABLE	10N1622RTPUW	Wood	\$ 1162	13¾	22	28½	—	—	32 lbs.	9.25
	10N1622RTPUL	Laminate	1162	13¾	22	28½	—	—	32 lbs.	9.25



- 50 lb. weight limit
- Specify metal finish (423) Concrete, (462) Cinder, (463) Iron, (501) Platinum Metallic, or (503) Satin Nickel Metallic
- Veneer species is maple
- Acorn is the laminate/wood complement to Clear Walnut finish

PERSONAL PULL-UP TABLE	10N1120RTPU2SS	White Marble	\$ 819	11	20	25	—	—	30 lbs.	5.00
	10N1620RTPU2SB	Black Marble	819	16	20	25	—	—	30 lbs.	6.95

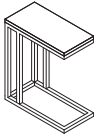

White Marble



Black Marble

- 50 lb. weight limit
- White Marble model has a Platinum Metallic base; Black Marble model has a Cinder base
- 10N1620RTPU2SB top material is Porcelain with pattern Nero Marquina
- 10N1120RTPU2SS top material is Natural Marble species of Bianco Crown Marble
- Specify model number only

PRODUCT SPECIFICATIONS

TOPS

- Laminate surfaces are 1" HPL (high pressure laminate)
- Veneer surfaces are 1" plain sliced slipmatched cherry (Amber, Autumn, Mocha, Truffle) or maple veneer (Brighton, Caramel, Honey, Natural), plain sliced bookmatched walnut veneer (Clear Walnut, Cordovan, Judicial), quarter cut walnut veneer (Almond, Portobello, Sable), or quarter cut oak veneer (Sonoma)
- When specifying Clear Walnut, a clear coat finish, the natural wood characteristics of walnut veneer are visible. These characteristics include, but are not limited to, color and woodgrain variation
- Solid surface is 1" thick
- Back painted glass surfaces have a 1" thick top including the glass and white substrate
- Veneer and Laminate models also available with standard core with a 3mm PVC rim which is 1" thick
- Grain direction runs left-to-right

RIM PROFILES

- An exposed plywood core for veneer will have color matched on the rim and will be a reversed half-bullnose.
- Clear Walnut will have a clear coat on the rim
- An exposed plywood core for laminate will have a clear coat on the rim and will be a reversed half-bullnose
- Back painted glass has a MDF core with 3D Laminate edge. It will be a reversed half-bullnose and will be white
- Solid surface does not have a plywood core but will have a reversed half-bullnose and will be the same color as the solid surface
- Veneer and laminate models are available with a 3mm rim option with a standard core. Veneer will have a softened wood rim, while laminate will have a softened PVC rim

UPHOLSTERED TOPS

- 1½" high grade polyurethane foam covers a ½" solid base

LEGS

- All Wixler legs are solid wood

FINISH APPLICATION

- All Veneer surfaces feature a semi-open pore matte finish

TOP/WOOD LEGS FINISHES

AC	Autumn
AD	Almond**
CL	Caramel
CW	Cordovan
DW	Judicial
EW	Clear Walnut**
HN	Honey
IM	Brighton
MC	Amber
MH	Mocha
NM	Natural
PB	Portobello
SM	Sonoma
TF	Truffle
792	Sable

TOP LAMINATE COLORS

WOODGRAIN LAMINATE

AC2	Autumn 2	MH	Mocha
AD	Almond	NM	Natural
BZ	Brazilwood	PB	Portobello
CI	Chai	PC	Porcini
CL	Caramel	PT	Portico
CW	Cordovan	SK	Skyline
DW	Judicial	SM	Sonoma
HN2	Honey 2	TF	Truffle
IM	Brighton	WL	Willow
KN	Kona	792	Sable
MC	Amber	793	Acorn*

SOLID LAMINATE

405	Designer White
419	Wallaby
425	Shadow
440	Cloud
457	Dapple
461	Graphite
462	Cinder
478	Platinum Grey
488	Frosty White
491	Designer White Linear
492	Cinder Linear

PATTERN LAMINATE

814	White Tigris
818	Crisp Linen
819	Flax Gauze
821	Elemental Concrete
822	Smoke Quarstone
874	Bronze Legacy

GALLERY LAMINATE

Grade 1 – 5% upcharge	
G1001	Citadel
G1011	Pepperdust
Grade 2 – 6% upcharge	
G1002	Planked Raw Oak
G1003	Evening Notte
G1004	Kirsche
G1005	Midnight Run
G1006	Sepia Walnut
G1007	Serotina
G1008	Timeless
G1009	White Nebbia
G1012	Phantom Ecru

*Acorn is the laminate complement to Clear Walnut finish

**Almond is the leg finish complement to Clear Walnut finish

• CSL available; see page 18 for program details and upcharge

See page 18 for Gallery program details and upcharges

RIM PROFILE OPTIONS

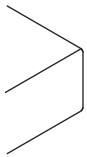

Softened PVC (V)
(laminates tops only)

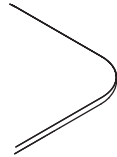

Reversed Half-Bullnose

PVC SOFTENED RIM

AC2	Autumn 2	MH	Mocha	425	Shadow
AD	Almond	NM	Natural	440	Cloud
BZ	Brazilwood	PB	Portobello	457	Dapple
CI	Chai	PC	Porcini	461	Graphite
CL	Caramel	PT	Portico	462	Cinder
CW	Cordovan	SK	Skyline	478	Platinum Grey
DW	Judicial	SM	Sonoma	488	Frosty White
HN2	Honey 2	TF	Truffle	491	Designer White Linear
IM	Brighton	WL	Willow	492	Cinder Linear
KN	Kona	405	Designer White	792	Sable
MC	Amber	419	Wallaby	793	Acorn

GALLERY PVC SOFTENED RIM

Grade 1 – 5% upcharge	
G1001	Citadel
G1011	Pepperdust
Grade 2 – 6% upcharge	
G1002	Planked Raw Oak
G1003	Evening Notte
G1004	Kirsche
G1005	Midnight Run
G1006	Sepia Walnut
G1007	Serotina
G1008	Timeless
G1009	White Nebbia
G1012	Phantom Ecru

BASE LEGS PAINT COLORS

405	Designer White
423	Concrete
462	Cinder
463	Iron
501	Platinum Metallic
503	Satin Nickel Metallic

SOLID SURFACE TOP OPTIONS

COLORS

7101	Bisque (Grade A)
7201	Glacier White (Grade A)
7202	Canyon (Grade B)
7203	Designer White (Grade B)
7204	Silt (Grade B)
7301	Concrete (Grade C)
7302	Deep Night Sky (Grade C)
7303	Deep Nocturne (Grade C)

RIM PROFILE



WIXLER OCCASIONAL TABLES

PRODUCT SPECIFICATIONS

- Wood, laminate, glass, and solid surface available. See page 523 for options
- Upholstered top available. See pages 10-17 for fabric options
- Legs are solid wood. See page 523 for color options
- Legs shipped in same box as top (KD)
- Wood and laminate have a plywood core with exposed rim detail. Glass has plywood core, but not exposed
- Wood and laminate available with standard core with 3mm edge detail

TO ORDER, SPECIFY:

1. Model Number
2. Laminate/Wood Color
3. Solid Surface Grade (Solid surface only)
4. Solid Surface Color (Solid surface only)
5. Leg Finish

SAMPLE MODEL NUMBER:

88NA4216TRDW CW 463

- See page 523 for all options available in Occasional Tables

	MODEL NO./DESCRIPTION	LIST PRICE			DIMENSIONS					CARTONED CUBIC	
		GRADE A	GRADE B	GRADE C	D	W	H	A	KW	WEIGHT	FEET
ROUND TOP	42" ROUND				DI		H				
	88NA4216TRDW Wood	\$ 2182			42	—	16	—	—	61 lbs.	10.7
	88NA4216TRDLW Laminate	2182			42	—	16	—	—	61 lbs.	10.7
	88NA4216TRDGW White Back Painted Glass	4214			42	—	16	—	—	109 lbs.	10.7
	88NA4216TRDSW Solid Surface	4373	4728	5194	42	—	16	—	—	86 lbs.	10.7
	88NA4216TRDVW Wood 3mm Rim	1801			42	—	16	—	—	61 lbs.	10.7
	88NA4216TRDVLW Laminate 3mm Rim	1529			42	—	16	—	—	61 lbs.	10.7
	88NA4218TRDW Wood	\$ 2210			42	—	18	—	—	62 lbs.	10.7
	88NA4218TRDLW Laminate	2210			42	—	18	—	—	62 lbs.	10.7
	88NA4218TRDGW White Back Painted Glass	4242			42	—	18	—	—	110 lbs.	10.7
	88NA4218TRDSW Solid Surface	4402	4757	5223	42	—	18	—	—	87 lbs.	10.7
	88NA4218TRDVW Wood 3mm Rim	1829			42	—	18	—	—	62 lbs.	10.7
	88NA4218TRDVLW Laminate 3mm Rim	1557			42	—	18	—	—	62 lbs.	10.7
	36" ROUND										
	88NA3616TRDW Wood	\$ 2087			36	—	16	—	—	47 lbs.	8.2
	88NA3616TRDLW Laminate	2087			36	—	16	—	—	47 lbs.	8.2
	88NA3616TRDGW White Back Painted Glass	3666			36	—	16	—	—	83 lbs.	8.2
	88NA3616TRDSW Solid Surface	3973	4234	4576	36	—	16	—	—	66 lbs.	8.2
	88NA3616TRDVW Wood 3mm Rim	1687			36	—	16	—	—	47 lbs.	8.2
	88NA3616TRDVLW Laminate 3mm Rim	1415			36	—	16	—	—	47 lbs.	8.2
	88NA3618TRDW Wood	\$ 2117			36	—	18	—	—	49 lbs.	8.2
	88NA3618TRDLW Laminate	2117			36	—	18	—	—	49 lbs.	8.2
	88NA3618TRDGW White Back Painted Glass	3694			36	—	18	—	—	84 lbs.	8.2
	88NA3618TRDSW Solid Surface	4002	4263	4605	36	—	18	—	—	67 lbs.	8.2
	88NA3618TRDVW Wood 3mm Rim	1716			36	—	18	—	—	49 lbs.	8.2
	88NA3618TRDVLW Laminate 3mm Rim	1444			36	—	18	—	—	49 lbs.	8.2

- Ships as one unit (KD)
- All models except for the wood and laminate 3mm have a reversed half-bullnose rim detail

PRODUCT SPECIFICATIONS

- Wood, laminate, glass, and solid surface available. See page 523 for options
- Upholstered top available. See pages 10-17 for fabric options
- Legs are solid wood. See page 523 for color options
- Legs shipped in same box as top (KD)
- Wood and laminate have a plywood core with exposed rim detail. Glass has plywood core, but not exposed
- Wood and laminate available with standard core with 3mm edge detail

TO ORDER, SPECIFY:

1. Model Number
2. Laminate/Wood Color
3. Solid Surface Grade (Solid surface only)
4. Solid Surface Color (Solid surface only)
5. Leg Finish

SAMPLE MODEL NUMBER:

88NA2416TRDW CW 463

- See page 523 for all options available in Occasional Tables

MODEL NO./DESCRIPTION	LIST PRICE			DIMENSIONS					CARTONED CUBIC		
	GRADE A	GRADE B	GRADE C	D	W	H	A	KW	WEIGHT	FEET	
24" ROUND				DI	H						
88NA2416TRDW Wood	\$ 1946			24	—	16	—	—	25 lbs.	4.2	
88NA2416TRDLW Laminate	1946			24	—	16	—	—	25 lbs.	4.2	
88NA2416TRDGW White Back Painted Glass	2842			24	—	16	—	—	41 lbs.	4.2	
88NA2416TRDSW Solid Surface	3377	3493	3645	24	—	16	—	—	33 lbs.	4.2	
88NA2416TRDVW Wood 3mm Rim	1574			24	—	16	—	—	25 lbs.	4.2	
88NA2416TRDVLW Laminate 3mm Rim	1302			24	—	16	—	—	25 lbs.	4.2	
Grade	1	2/COM	3/COL	4	5	6	7	L7	L8		
88NA2417TRDFW Fabric	\$ 2002	2027	2038	2057	2077	2111	2156	2372	2441		

ROUND TOP
(CONTINUED)



ALLIANCE GRADE / LIST PRICE

	A	B	C	D	E	F	G	H	I	J
\$	2044	2070	2090	2112	2135	2160	2180	2206	2232	2258
	K	L	M	N	O	P	Q	R	S	T
\$	2298	2379	2430	2456	2483	2509	2535	2560	2586	2611

DIMENSIONS

Diameter	24	Weight	25
Height	17	Cubic Ft.	4.2

88NA2418TRDW Wood	\$ 1974			24	—	18	—	—	26 lbs.	4.2
88NA2418TRDLW Laminate	1974			24	—	18	—	—	26 lbs.	4.2
88NA2418TRDGW White Back Painted Glass	2871			24	—	18	—	—	42 lbs.	4.2
88NA2418TRDSW Solid Surface	3405	3521	3673	24	—	18	—	—	35 lbs.	4.2
88NA2418TRDVW Wood 3mm Rim	1602			24	—	18	—	—	26 lbs.	4.2
88NA2418TRDVLW Laminate 3mm Rim	1330			24	—	18	—	—	26 lbs.	4.2
Grade	1	2/COM	3/COL	4	5	6	7	L7	L8	
88NA2419TRDFW Fabric	\$ 2031	2056	2067	2086	2106	2140	2185	2401	2470	

ALLIANCE GRADE / LIST PRICE

	A	B	C	D	E	F	G	H	I	J
\$	2073	2099	2119	2141	2164	2189	2209	2235	2261	2287
	K	L	M	N	O	P	Q	R	S	T
\$	2327	2408	2459	2485	2512	2538	2564	2589	2615	2640

DIMENSIONS

Diameter	24	Weight	26
Height	19	Cubic Ft.	4.2

- Ships as one unit (KD)
- All models except for the wood and laminate 3mm have a reversed half-bullnose rim detail

WIXLER OCCASIONAL TABLES

PRODUCT SPECIFICATIONS

- Wood, laminate, glass, and solid surface available. See page 523 for options
- Upholstered top available. See pages 10-17 for fabric options
- Legs are solid wood. See page 523 for color options
- Legs shipped in same box as top (KD)
- Wood and laminate have a plywood core with exposed rim detail. Glass has plywood core, but not exposed
- Wood and laminate available with standard core with 3mm edge detail

TO ORDER, SPECIFY:

1. Model Number
2. Laminate/Wood Color
3. Solid Surface Grade (Solid surface only)
4. Solid Surface Color (Solid surface only)
5. Leg Finish

SAMPLE MODEL NUMBER:

88NA2420TRDW CW 463

- See page 523 for all options available in Occasional Tables

MODEL NO./DESCRIPTION	LIST PRICE			DIMENSIONS					CARTONED CUBIC	
	GRADE A	GRADE B	GRADE C	D	W	H	A	KW	WEIGHT	FEET
ROUND TOP (CONTINUED)										
										
24" ROUND										
88NA2420TRDW Wood	\$ 2002			24	—	20	—	—	28 lbs.	4.2
88NA2420TRDLW Laminate	2002			24	—	20	—	—	28 lbs.	4.2
88NA2420TRDGW White Back Painted Glass	2899			24	—	20	—	—	43 lbs.	4.2
88NA2420TRDSW Solid Surface	3434	3550	3702	24	—	20	—	—	36 lbs.	4.2
88NA2420TRDVW Wood 3mm Rim	1631			24	—	20	—	—	28 lbs.	4.2
88NA2420TRDVLW Laminate 3mm Rim	1359			24	—	20	—	—	28 lbs.	4.2
24" ROUND (continued)										
88NA2422TRDW Wood	\$ 2031			24	—	22	—	—	29 lbs.	4.2
88NA2422TRDLW Laminate	2031			24	—	22	—	—	29 lbs.	4.2
88NA2422TRDGW White Back Painted Glass	2927			24	—	22	—	—	45 lbs.	4.2
88NA2422TRDSW Solid Surface	3462	3578	3730	24	—	22	—	—	37 lbs.	4.2
88NA2422TRDVW Wood 3mm Rim	1659			24	—	22	—	—	29 lbs.	4.2
88NA2422TRDVLW Laminate 3mm Rim	1387			24	—	22	—	—	29 lbs.	4.2
18" ROUND										
88NA1816TRDW Wood	\$ 1851			18	—	16	—	—	19 lbs.	3.1
88NA1816TRDLW Laminate	1851			18	—	16	—	—	19 lbs.	3.1
88NA1816TRDGW White Back Painted Glass	2294			18	—	16	—	—	28 lbs.	3.1
88NA1816TRDSW Solid Surface	2976	3040	3123	18	—	16	—	—	24 lbs.	3.1
88NA1816TRDVW Wood 3mm Rim	1460			18	—	16	—	—	19 lbs.	3.1
88NA1816TRDVLW Laminate 3mm Rim	1189			18	—	16	—	—	19 lbs.	3.1
Grade	1	2/COM	3/COL	4	5	6	7	L7	L8	
88NA1817TRDFW Fabric	\$ 1908	1928	1936	1951	1966	1993	2028	2196	2250	

ALLIANCE GRADE / LIST PRICE

	A	B	C	D	E	F	G	H	I	J
\$	1941	1961	1977	1993	2012	2031	2047	2067	2087	2107
	K	L	M	N	O	P	Q	R	S	T
\$	2138	2201	2241	2261	2282	2302	2322	2342	2362	2382

DIMENSIONS

Diameter	18	Weight	19
Height	17	Cubic Ft.	3.1

- Ships as one unit (KD)
- All models except for the wood and laminate 3mm have a reversed half-bullnose rim detail

WIXLER OCCASIONAL TABLES

PRODUCT SPECIFICATIONS

- Wood, laminate, glass, and solid surface available. See page 523 for options
- Upholstered top available. See pages 10-17 for fabric options
- Legs are solid wood. See page 523 for color options
- Legs shipped in same box as top (KD)
- Wood and laminate have a plywood core with exposed rim detail. Glass has plywood core, but not exposed
- Wood and laminate available with standard core with 3mm edge detail

TO ORDER, SPECIFY:

1. Model Number
2. Laminate/Wood Color
3. Solid Surface Grade (Solid surface only)
4. Solid Surface Color (Solid surface only)
5. Leg Finish

SAMPLE MODEL NUMBER:

88NA1818TRDW CW 463

- See page 523 for all options available in Occasional Tables

MODEL NO./DESCRIPTION	LIST PRICE			DIMENSIONS					CARTONED CUBIC		
	GRADE A	GRADE B	GRADE C	D	W	H	A	KW	WEIGHT	FEET	
ROUND TOP (CONTINUED)	18" ROUND			DI	H						
88NA1818TRDW Wood	\$ 1880			18	—	18	—	—	21 lbs.	3.1	
88NA1818TRDLW Laminate	1880			18	—	18	—	—	21 lbs.	3.1	
88NA1818TRDGW White Back Painted Glass	2323			18	—	18	—	—	29 lbs.	3.1	
88NA1818TRDSW Solid Surface	3004	3068	3151	18	—	18	—	—	25 lbs.	3.1	
88NA1818TRDVW Wood 3mm Rim	1489			18	—	18	—	—	21 lbs.	3.1	
88NA1818TRDVLW Laminate 3mm Rim	1217			18	—	18	—	—	21 lbs.	3.1	
Grade	1	2/COM	3/COL	4	5	6	7	L7	L8		
88NA1819TRDFW Fabric	\$ 1936	1956	1964	1979	1994	2021	2056	2224	2278		



ALLIANCE GRADE / LIST PRICE

	A	B	C	D	E	F	G	H	I	J
\$	1969	1989	2005	2021	2040	2059	2075	2095	2115	2135
	K	L	M	N	O	P	Q	R	S	T
\$	2166	2229	2269	2289	2310	2330	2350	2370	2390	2410

DIMENSIONS

Diameter	18	Weight	21
Height	19	Cubic Ft.	3.1

88NA1820TRDW Wood	\$ 1908			18	—	20	—	—	23 lbs.	3.4
88NA1820TRDLW Laminate	1908			18	—	20	—	—	23 lbs.	3.4
88NA1820TRDGW White Back Painted Glass	2351			18	—	20	—	—	32 lbs.	3.4
88NA1820TRDSW Solid Surface	3032	3096	3179	18	—	20	—	—	28 lbs.	3.4
88NA1820TRDVW Wood 3mm Rim	1517			18	—	20	—	—	23 lbs.	3.4
88NA1820TRDVLW Laminate 3mm Rim	1245			18	—	20	—	—	23 lbs.	3.4
88NA1822TRDW Wood	\$ 1936			18	—	22	—	—	25 lbs.	3.7
88NA1822TRDLW Laminate	1936			18	—	22	—	—	25 lbs.	3.7
88NA1822TRDGW White Back Painted Glass	2379			18	—	22	—	—	34 lbs.	3.7
88NA1822TRDSW Solid Surface	3061	3125	3208	18	—	22	—	—	30 lbs.	3.7
88NA1822TRDVW Wood 3mm Rim	1546			18	—	22	—	—	25 lbs.	3.7
88NA1822TRDVLW Laminate 3mm Rim	1274			18	—	22	—	—	25 lbs.	3.7

- Ships as one unit (KD)
- All models except for the wood and laminate 3mm have a reversed half-bullnose rim detail

WIXLER OCCASIONAL TABLES

PRODUCT SPECIFICATIONS

- Wood, laminate, glass, and solid surface available. See page 523 for options
- Upholstered top available. See pages 10-17 for fabric options
- Legs are solid wood. See page 523 for color options
- Legs shipped in same box as top (KD)
- Wood and laminate have a plywood core with exposed rim detail. Glass has plywood core, but not exposed
- Wood and laminate available with standard core with 3mm edge detail

TO ORDER, SPECIFY:

1. Model Number
2. Laminate/Wood Color
3. Solid Surface Grade (Solid surface only)
4. Solid Surface Color (Solid surface only)
5. Leg Finish

SAMPLE MODEL NUMBER:

88NA424216TSQLW SM 503

- See page 523 for all options available in Occasional Tables

	MODEL NO./DESCRIPTION	LIST PRICE			DIMENSIONS					CARTONED CUBIC	
		GRADE A	GRADE B	GRADE C	D	W	H	A	KW	WEIGHT	FEET
	42" SQUARE										
	88NA424216TSQW	Wood	\$	2182						72 lbs.	10.7
	88NA424216TSQLW	Laminate		2182						72 lbs.	10.7
	88NA424216TSQGW	White Back Painted Glass		4214						133 lbs.	10.7
	88NA424216TSQSW	Solid Surface		4373	4728	5194				104 lbs.	10.7
	88NA424216TSQVW	Wood 3mm Rim		1801						72 lbs.	10.7
	88NA424216TSQVLW	Laminate 3mm Rim		1529						72 lbs.	10.7
	42" SQUARE										
	88NA424218TSQW	Wood	\$	2210						73 lbs.	10.7
	88NA424218TSQLW	Laminate		2210						73 lbs.	10.7
	88NA424218TSQGW	White Back Painted Glass		4242						134 lbs.	10.7
	88NA424218TSQSW	Solid Surface		4402	4757	5223				105 lbs.	10.7
	88NA424218TSQVW	Wood 3mm Rim		1829						73 lbs.	10.7
	88NA424218TSQVLW	Laminate 3mm Rim		1557						73 lbs.	10.7
	36" SQUARE										
	88NA363616TSQW	Wood	\$	2087						55 lbs.	8.2
	88NA363616TSQLW	Laminate		2087						55 lbs.	8.2
	88NA363616TSQGW	White Back Painted Glass		3666						100 lbs.	8.2
	88NA363616TSQSW	Solid Surface		3973	4234	4576				79 lbs.	8.2
	88NA363616TSQVW	Wood 3mm Rim		1687						55 lbs.	8.2
88NA363616TSQVLW	Laminate 3mm Rim		1415						55 lbs.	8.2	
36" SQUARE											
88NA363618TSQW	Wood	\$	2117						57 lbs.	8.2	
88NA363618TSQLW	Laminate		2117						57 lbs.	8.2	
88NA363618TSQGW	White Back Painted Glass		3694						102 lbs.	8.2	
88NA363618TSQSW	Solid Surface		4002	4263	4605				80 lbs.	8.2	
88NA363618TSQVW	Wood 3mm Rim		1716						57 lbs.	8.2	
88NA363618TSQVLW	Laminate 3mm Rim		1444						57 lbs.	8.2	

- Ships as one unit (KD)
- All models except for the wood and laminate 3mm have a reversed half-bullnose rim detail

PRODUCT SPECIFICATIONS

- Wood, laminate, glass, and solid surface available. See page 523 for options
- Upholstered top available. See pages 10-17 for fabric options
- Legs are solid wood. See page 523 for color options
- Legs shipped in same box as top (KD)
- Wood and laminate have a plywood core with exposed rim detail. Glass has plywood core, but not exposed
- Wood and laminate available with standard core with 3mm edge detail

TO ORDER, SPECIFY:

1. Model Number
2. Laminate/Wood Color
3. Solid Surface Grade (Solid surface only)
4. Solid Surface Color (Solid surface only)
5. Leg Finish

SAMPLE MODEL NUMBER:

88NA242416TSQLW SM 503

- See page 523 for all options available in Occasional Tables

MODEL NO./DESCRIPTION	LIST PRICE			DIMENSIONS					CARTONED CUBIC	
	GRADE A	GRADE B	GRADE C	D	W	H	A	KW	WEIGHT	FEET
SOFT SQUARE TOP (CONTINUED)	24" SQUARE									
88NA242416TSQW Wood	\$ 1946			24	24	16	—	—	29 lbs.	4.2
88NA242416TSQLW Laminate	1946			24	24	16	—	—	29 lbs.	4.2
88NA242416TSQGW White Back Painted Glass	2842			24	24	16	—	—	49 lbs.	4.2
88NA242416TSQSW Solid Surface	3377	3493	3645	24	24	16	—	—	39 lbs.	4.2
88NA242416TSQVW Wood 3mm Rim	1574			24	24	16	—	—	29 lbs.	4.2
88NA242416TSQVLW Laminate 3mm Rim	1302			24	24	16	—	—	29 lbs.	4.2
Grade	1	2/COM	3/COL	4	5	6	7	L7	L8	
88NA242417TSQFW Fabric	\$ 2002	2027	2038	2057	2077	2111	2156	2372	2441	



ALLIANCE GRADE / LIST PRICE

	A	B	C	D	E	F	G	H	I	J
\$	2044	2070	2090	2112	2135	2160	2180	2206	2232	2258
	K	L	M	N	O	P	Q	R	S	T
\$	2298	2379	2430	2456	2483	2509	2535	2560	2586	2611

DIMENSIONS

Depth	24	Weight	29
Width	24	Cubic Ft.	4.2
Height	17		

88NA242418TSQW Wood	\$ 1974			24	24	18	—	—	30 lbs.	4.2
88NA242418TSQLW Laminate	1974			24	24	18	—	—	30 lbs.	4.2
88NA242418TSQGW White Back Painted Glass	2871			24	24	18	—	—	40 lbs.	4.2
88NA242418TSQSW Solid Surface	3405	3521	3673	24	24	18	—	—	40 lbs.	4.2
88NA242418TSQVW Wood 3mm Rim	1602			24	24	18	—	—	30 lbs.	4.2
88NA242418TSQVLW Laminate 3mm Rim	1330			24	24	18	—	—	30 lbs.	4.2
Grade	1	2/COM	3/COL	4	5	6	7	L7	L8	
88NA242419TSQFW Fabric	\$ 2031	2056	2067	2086	2106	2140	2185	2401	2470	

ALLIANCE GRADE / LIST PRICE

	A	B	C	D	E	F	G	H	I	J
\$	2073	2099	2119	2141	2164	2189	2209	2235	2261	2287
	K	L	M	N	O	P	Q	R	S	T
\$	2327	2408	2459	2485	2512	2538	2564	2589	2615	2640

DIMENSIONS

Depth	24	Weight	30
Width	24	Cubic Ft.	4.2
Height	19		

- Ships as one unit (KD)
- All models except for the wood and laminate 3mm have a reversed half-bullnose rim detail

WIXLER OCCASIONAL TABLES

PRODUCT SPECIFICATIONS

- Wood, laminate, glass, and solid surface available. See page 523 for options
- Upholstered top available. See pages 10-17 for fabric options
- Legs are solid wood. See page 523 for color options
- Legs shipped in same box as top (KD)
- Wood and laminate have a plywood core with exposed rim detail. Glass has plywood core, but not exposed
- Wood and laminate available with standard core with 3mm edge detail

TO ORDER, SPECIFY:

1. Model Number
2. Laminate/Wood Color
3. Solid Surface Grade (Solid surface only)
4. Solid Surface Color (Solid surface only)
5. Leg Finish

SAMPLE MODEL NUMBER:

88NA242420TSQSW A 7201 501

- See page 523 for all options available in Occasional Tables

MODEL NO./DESCRIPTION	LIST PRICE			DIMENSIONS					CARTONED CUBIC	
	D	W	H	A	KW	WEIGHT	FEET			
SOFT SQUARE TOP (CONTINUED)	24" SQUARE			GRADE A	GRADE B	GRADE C				
88NA242420TSQW Wood				\$ 2002					31 lbs.	4.2
88NA242420TSQLW Laminate				2002					31 lbs.	4.2
88NA242420TSQGW White Back Painted Glass				2899					51 lbs.	4.2
88NA242420TSQSW Solid Surface				3434	3550	3702			42 lbs.	4.2
88NA242420TSQVW Wood 3mm Rim				1631					31 lbs.	4.2
88NA242420TSQVLW Laminate 3mm Rim				1359					31 lbs.	4.2
88NA242422TSQW Wood				\$ 2031					33 lbs.	4.2
88NA242422TSQLW Laminate				2031					33 lbs.	4.2
88NA242422TSQGW White Back Painted Glass				2927					53 lbs.	4.2
88NA242422TSQSW Solid Surface				3462	3578	3730			43 lbs.	4.2
88NA242422TSQVW Wood 3mm Rim				1659					33 lbs.	4.2
88NA242422TSQVLW Laminate 3mm Rim				1387					33 lbs.	4.2
	18" SQUARE									
88NA181816TSQW Wood				\$ 1851					21 lbs.	3.1
88NA181816TSQLW Laminate				1851					21 lbs.	3.1
88NA181816TSQGW White Back Painted Glass				2294					33 lbs.	3.1
88NA181816TSQSW Solid Surface				2976	3040	3123			27 lbs.	3.1
88NA181816TSQVW Wood 3mm Rim				1460					21 lbs.	3.1
88NA181816TSQVLW Laminate 3mm Rim				1189					21 lbs.	3.1
	Grade	1	2/COM	3/COL	4	5	6	7	L7	L8
88NA181817TSQFW Fabric	\$	1908	1928	1936	1951	1966	1993	2028	2196	2250

ALLIANCE GRADE / LIST PRICE

	A	B	C	D	E	F	G	H	I	J
\$	1941	1961	1977	1993	2012	2031	2047	2067	2087	2107
	K	L	M	N	O	P	Q	R	S	T
\$	2138	2201	2241	2261	2282	2302	2322	2342	2362	2382

DIMENSIONS

Depth	18	Weight	21
Width	18	Cubic Ft.	3.1
Height	17		

- Ships as one unit (KD)
- All models except for the wood and laminate 3mm have a reversed half-bullnose rim detail



PRODUCT SPECIFICATIONS

- Wood, laminate, glass, and solid surface available. See page 523 for options
- Upholstered top available. See pages 10-17 for fabric options
- Legs are solid wood. See page 523 for color options
- Legs shipped in same box as top (KD)
- Wood and laminate have a plywood core with exposed rim detail. Glass has plywood core, but not exposed
- Wood and laminate available with standard core with 3mm edge detail

TO ORDER, SPECIFY:

1. Model Number
2. Laminate/Wood Color
3. Solid Surface Grade (Solid surface only)
4. Solid Surface Color (Solid surface only)
5. Leg Finish

SAMPLE MODEL NUMBER:

88NA181820TSQSW A 7201 501
 • See page 523 for all options available in Occasional Tables

MODEL NO./DESCRIPTION	LIST PRICE			DIMENSIONS					CARTONED CUBIC	
	GRADE A	GRADE B	GRADE C	D	W	H	A	KW	WEIGHT	FEET
SOFT SQUARE TOP (CONTINUED)										
18" SQUARE										
88NA181818TSQW Wood	\$ 1880			18	18	18	—	—	23 lbs.	3.1
88NA181818TSQLW Laminate	1880			18	18	18	—	—	23 lbs.	3.1
88NA181818TSQGW White Back Painted Glass	2323			18	18	18	—	—	34 lbs.	3.1
88NA181818TSQSW Solid Surface	3004	3068	3151	18	18	18	—	—	29 lbs.	3.1
88NA181818TSQVW Wood 3mm Rim	1489			18	18	18	—	—	23 lbs.	3.1
88NA181818TSQVLW Laminate 3mm Rim	1217			18	18	18	—	—	23 lbs.	3.1
Grade	1	2/COM	3/COL	4	5	6	7	L7	L8	
88NA181819TSQFW Fabric	\$ 1936	1956	1964	1979	1994	2021	2056	2224	2278	



ALLIANCE GRADE / LIST PRICE

	A	B	C	D	E	F	G	H	I	J
\$	1969	1989	2005	2021	2040	2059	2075	2095	2115	2135
	K	L	M	N	O	P	Q	R	S	T
\$	2166	2229	2269	2289	2310	2330	2350	2370	2390	2410

DIMENSIONS

Depth	18	Weight	23
Width	18	Cubic Ft.	3.1
Height	19		

88NA181820TSQW Wood	\$ 1908			18	18	20	—	—	25 lbs.	3.4
88NA181820TSQLW Laminate	1908			18	18	20	—	—	25 lbs.	3.4
88NA181820TSQGW White Back Painted Glass	2351			18	18	20	—	—	36 lbs.	3.4
88NA181820TSQSW Solid Surface	3032	3096	3179	18	18	20	—	—	31 lbs.	3.4
88NA181820TSQVW Wood 3mm Rim	1517			18	18	20	—	—	25 lbs.	3.4
88NA181820TSQVLW Laminate 3mm Rim	1245			18	18	20	—	—	25 lbs.	3.4
88NA181822TSQW Wood	\$ 1936			18	18	22	—	—	24 lbs.	3.6
88NA181822TSQLW Laminate	1936			18	18	22	—	—	24 lbs.	3.6
88NA181822TSQGW White Back Painted Glass	2379			18	18	22	—	—	36 lbs.	3.6
88NA181822TSQSW Solid Surface	3061	3125	3208	18	18	22	—	—	30 lbs.	3.6
88NA181822TSQVW Wood 3mm Rim	1546			18	18	22	—	—	24 lbs.	3.6
88NA181822TSQVLW Laminate 3mm Rim	1274			18	18	22	—	—	24 lbs.	3.6

- Ships as one unit (KD)
- All models except for the wood and laminate 3mm have a reversed half-bullnose rim detail

WIXLER OCCASIONAL TABLES

PRODUCT SPECIFICATIONS

- Wood, laminate, glass, and solid surface available. See page 523 for options
- Legs are solid wood. See page 523 for color options
- Legs shipped in same box as top (KD)
- Wood and laminate have a plywood core with exposed rim detail. Glass has plywood core, but not exposed
- Wood and laminate available with standard core with 3mm edge detail

TO ORDER, SPECIFY:

1. Model Number
2. Laminate/Wood Color
3. Solid Surface Grade (Solid surface only)
4. Solid Surface Color (Solid surface only)
5. Leg Finish

SAMPLE MODEL NUMBER:

88NA306016TRTVW PB 463

- See page 523 for all options available in Occasional Tables

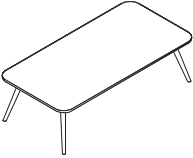
	MODEL NO./DESCRIPTION	LIST PRICE			DIMENSIONS					CARTONED CUBIC		
		GRADE A	GRADE B	GRADE C	D	W	H	A	KW	WEIGHT	FEET	
SOFT RECTANGLE TOP 	30" X 60"											
	88NA306016TRTW	Wood	\$ 2335			30	60	16	—	—	74 lbs.	11.0
	88NA306016TRLW	Laminate	2335			30	60	16	—	—	74 lbs.	11.0
	88NA306016TRTGW	White Back Painted Glass	3888			30	60	16	—	—	136 lbs.	11.0
	88NA306016TRTSW	Solid Surface	4278	4626	5082	30	60	16	—	—	106 lbs.	11.0
	88NA306016TRTVW	Wood 3mm Rim	1907			30	60	16	—	—	74 lbs.	11.0
	88NA306016TRTVLW	Laminate 3mm Rim	1635			30	60	16	—	—	74 lbs.	11.0
	<hr/>											
	88NA306018TRTW	Wood	\$ 2364			30	60	18	—	—	75 lbs.	11.0
	88NA306018TRLW	Laminate	2364			30	60	18	—	—	75 lbs.	11.0
	88NA306018TRTGW	White Back Painted Glass	3917			30	60	18	—	—	138 lbs.	11.0
	88NA306018TRTSW	Solid Surface	4306	4654	5110	30	60	18	—	—	108 lbs.	11.0
	88NA306018TRTVW	Wood 3mm Rim	1935			30	60	18	—	—	75 lbs.	11.0
	88NA306018TRTVLW	Laminate 3mm Rim	1663			30	60	18	—	—	75 lbs.	11.0
	<hr/>											
	24" X 48"											
	88NA244816TRTW	Wood	\$ 2104			24	48	16	—	—	50 lbs.	7.4
	88NA244816TRLW	Laminate	2104			24	48	16	—	—	50 lbs.	7.4
88NA244816TRTGW	White Back Painted Glass	3340			24	48	16	—	—	90 lbs.	7.4	
88NA244816TRTSW	Solid Surface	3877	4106	4406	24	48	16	—	—	71 lbs.	7.4	
88NA244816TRTVW	Wood 3mm Rim	1676			24	48	16	—	—	50 lbs.	7.4	
88NA244816TRTVLW	Laminate 3mm Rim	1403			24	48	16	—	—	50 lbs.	7.4	
<hr/>												
88NA244818TRTW	Wood	\$ 2133			24	48	18	—	—	51 lbs.	7.4	
88NA244818TRLW	Laminate	2133			24	48	18	—	—	51 lbs.	7.4	
88NA244818TRTGW	White Back Painted Glass	3368			24	48	18	—	—	92 lbs.	7.4	
88NA244818TRTSW	Solid Surface	3905	4134	4434	24	48	18	—	—	72 lbs.	7.4	
88NA244818TRTVW	Wood 3mm Rim	1704			24	48	18	—	—	51 lbs.	7.4	
88NA244818TRTVLW	Laminate 3mm Rim	1431			24	48	18	—	—	51 lbs.	7.4	

- Ships as one unit (KD)
- All models except for the wood and laminate 3mm have a reversed half-bullnose rim detail

WIXLER OCCASIONAL TABLES

PRODUCT SPECIFICATIONS

- Wood, laminate, glass, and solid surface available. See page 523 for options
- Legs are solid wood. See page 523 for color options
- Legs shipped in same box as top (KD)
- Wood and laminate have a plywood core with exposed rim detail. Glass has plywood core, but not exposed
- Wood and laminate available with standard core with 3mm edge detail

TO ORDER, SPECIFY:

1. Model Number
2. Laminate/Wood Color
3. Solid Surface Grade (Solid surface only)
4. Solid Surface Color (Solid surface only)
5. Leg Finish

SAMPLE MODEL NUMBER:

88NA183618TRTVW PB 463

- See page 523 for all options available in Occasional Tables

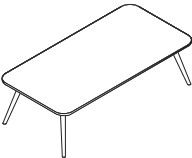
	MODEL NO./DESCRIPTION	LIST PRICE			DIMENSIONS					CARTONED CUBIC		
		GRADE A	GRADE B	GRADE C	D	W	H	A	KW	WEIGHT	FEET	
SOFT RECTANGLE TOP (CONTINUED) 	18" X 36"											
	88NA183616TRTW	Wood	\$ 1874			18	36	16	—	—	32 lbs.	4.6
	88NA183616TRTLW	Laminate	1874			18	36	16	—	—	32 lbs.	4.6
	88NA183616TRTGW	White Back Painted Glass	2791			18	36	16	—	—	54 lbs.	4.6
	88NA183616TRTSW	Solid Surface	3474	3602	3769	18	36	16	—	—	43 lbs.	4.6
	88NA183616TRTVW	Wood 3mm Rim	1591			18	36	16	—	—	32 lbs.	4.6
	88NA183616TRTVLW	Laminate 3mm Rim	1318			18	36	16	—	—	32 lbs.	4.6
	<hr/>											
	88NA183618TRTW	Wood	\$ 1903			18	36	18	—	—	33 lbs.	4.6
	88NA183618TRTLW	Laminate	1903			18	36	18	—	—	33 lbs.	4.6
	88NA183618TRTGW	White Back Painted Glass	2819			18	36	18	—	—	55 lbs.	4.6
	88NA183618TRTSW	Solid Surface	3503	3631	3798	18	36	18	—	—	45 lbs.	4.6
88NA183618TRTVW	Wood 3mm Rim	1619			18	36	18	—	—	33 lbs.	4.6	
88NA183618TRTVLW	Laminate 3mm Rim	1346			18	36	18	—	—	33 lbs.	4.6	
<hr/>												
88NA183620TRTW	Wood	\$ 1931			18	36	20	—	—	35 lbs.	5.1	
88NA183620TRTLW	Laminate	1931			18	36	20	—	—	35 lbs.	5.1	
88NA183620TRTGW	White Back Painted Glass	2848			18	36	20	—	—	58 lbs.	5.1	
88NA183620TRTSW	Solid Surface	3531	3659	3826	18	36	20	—	—	47 lbs.	5.1	
88NA183620TRTVW	Wood 3mm Rim	1647			18	36	20	—	—	35 lbs.	5.1	
88NA183620TRTVLW	Laminate 3mm Rim	1374			18	36	20	—	—	35 lbs.	5.1	
<hr/>												
88NA183622TRTW	Wood	\$ 1959			18	36	22	—	—	37 lbs.	5.4	
88NA183622TRTLW	Laminate	1959			18	36	22	—	—	37 lbs.	5.4	
88NA183622TRTGW	White Back Painted Glass	2876			18	36	22	—	—	59 lbs.	5.4	
88NA183622TRTSW	Solid Surface	3560	3688	3855	18	36	22	—	—	48 lbs.	5.4	
88NA183622TRTVW	Wood 3mm Rim	1676			18	36	22	—	—	37 lbs.	5.4	
88NA183622TRTVLW	Laminate 3mm Rim	1403			18	36	22	—	—	37 lbs.	5.4	

- Ships as one unit (KD)
- All models except for the wood and laminate 3mm have a reversed half-bullnose rim detail

WIXLER OCCASIONAL TABLES

PRODUCT SPECIFICATIONS

- Wood, laminate, glass, and solid surface available. See page 523 for options
- Upholstered top available. See pages 10-17 for fabric options
- Legs are solid wood. See page 523 for color options
- Legs shipped in same box as top (KD)
- Wood and laminate have a plywood core with exposed rim detail. Glass has plywood core, but not exposed
- Wood and laminate available with standard core with 3mm edge detail

TO ORDER, SPECIFY:

1. Model Number
2. Laminate/Wood Color
3. Solid Surface Grade (Solid surface only)
4. Solid Surface Color (Solid surface only)
5. Leg Finish

SAMPLE MODEL NUMBER:

88NA182416TRTLW 488 402

- See page 523 for all options available in Occasional Tables

MODEL NO./DESCRIPTION	LIST PRICE				DIMENSIONS					CARTONED CUBIC	
	GRADE A	GRADE B	GRADE C		D	W	H	A	KW	WEIGHT	FEET
SOFT RECTANGLE TOP (CONTINUED)	18" X 24"										
88NA182416TRTW Wood	\$ 1726				18	24	16	--	--	22 lbs.	3.3
88NA182416TRTLW Laminate	1726				18	24	16	--	--	22 lbs.	3.3
88NA182416TRTGW White Back Painted Glass	2644				18	24	16	--	--	37 lbs.	3.3
88NA182416TRTSW Solid Surface	3327	3411	3521		18	24	16	--	--	30 lbs.	3.3
88NA182416TRTVW Wood 3mm Rim	1506				18	24	16	--	--	22 lbs.	3.3
88NA182416TRTVLW Laminate 3mm Rim	1233				18	24	16	--	--	22 lbs.	3.3
Grade	1	2/COM	3/COL	4	5	6	7	L7	L8		
88NA182417TRTFW Fabric	\$ 1783	1803	1811	1826	1841	1868	1903	2071	2125		

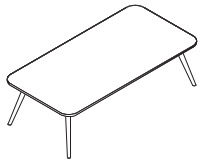

ALLIANCE GRADE / LIST PRICE

	A	B	C	D	E	F	G	H	I	J
\$	1816	1836	1852	1868	1887	1906	1922	1942	1962	1982
	K	L	M	N	O	P	Q	R	S	T
\$	2013	2076	2116	2136	2157	2177	2197	2217	2237	2257

DIMENSIONS

Depth	18	Weight	22
Width	24	Cubic Ft.	3.3
Height	17		

88NA182418TRTW Laminate	\$ 1755				18	24	18	--	--	24 lbs.	3.3
88NA182418TRTLW Laminate	1755				18	24	18	--	--	24 lbs.	3.3
88NA182418TRTGW White Back Painted Glass	2672				18	24	18	--	--	39 lbs.	3.3
88NA182418TRTSW Solid Surface	3356	3440	3550		18	24	18	--	--	32 lbs.	3.3
88NA182418TRTVW Wood 3mm Rim	1534				18	24	18	--	--	24 lbs.	3.3
88NA182418TRTVLW Laminate 3mm Rim	1261				18	24	18	--	--	24 lbs.	3.3
Grade	1	2/COM	3/COL	4	5	6	7	L7	L8		
88NA182419TRTFW Fabric	\$ 1840	1860	1868	1883	1898	1925	1960	2128	2182		

ALLIANCE GRADE / LIST PRICE

	A	B	C	D	E	F	G	H	I	J
\$	1873	1893	1909	1925	1944	1963	1979	1999	2019	2039
	K	L	M	N	O	P	Q	R	S	T
\$	2070	2133	2173	2193	2214	2234	2254	2274	2294	2314

DIMENSIONS

Depth	18	Weight	24
Width	24	Cubic Ft.	3.3
Height	19		

- Ships as one unit (KD)
- All models except for the wood and laminate 3mm have a reversed half-bullnose rim detail

WIXLER OCCASIONAL TABLES

PRODUCT SPECIFICATIONS

- Wood, laminate, glass, and solid surface available.
See page 523 for options
- Legs are solid wood. See page 523 for color options
- Legs shipped in same box as top (KD)
- Wood and laminate have a plywood core with exposed rim detail. Glass has plywood core, but not exposed
- Wood and laminate available with standard core with 3mm edge detail

TO ORDER, SPECIFY:

1. Model Number
2. Laminate/Wood Color
3. Solid Surface Grade (Solid surface only)
4. Solid Surface Color (Solid surface only)
5. Leg Finish

SAMPLE MODEL NUMBER:

88NA182420TRTLW 488 402

- See page 523 for all options available in Occasional Tables

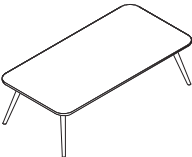
	MODEL NO./DESCRIPTION	LIST PRICE			DIMENSIONS					CARTONED CUBIC		
		GRADE A	GRADE B	GRADE C	D	W	H	A	KW	WEIGHT	FEET	
SOFT RECTANGLE TOP (CONTINUED) 	18" X 24"											
	88NA182420TRTW Wood	\$ 1783			18	24	20	—	—	28 lbs.	3.6	
	88NA182420TRLW Laminate	1783			18	24	20	—	—	28 lbs.	3.6	
	88NA182420TRTGW White Back Painted Glass	2701			18	24	20	—	—	43 lbs.	3.6	
	88NA182420TRTSW Solid Surface	3384	3468	3578	18	24	20	—	—	36 lbs.	3.6	
	88NA182420TRTVW Wood 3mm Rim	1562			18	24	20	—	—	28 lbs.	3.6	
	88NA182420TRTVLW Laminate 3mm Rim	1289			18	24	20	—	—	28 lbs.	3.6	
	<hr/>											
	88NA182422TRTW Wood	\$ 1811			18	24	22	—	—	27 lbs.	3.9	
	88NA182422TRLW Laminate	1811			18	24	22	—	—	27 lbs.	3.9	
	88NA182422TRTGW White Back Painted Glass	2729			18	24	22	—	—	42 lbs.	3.9	
	88NA182422TRTSW Solid Surface	3413	3497	3607	18	24	22	—	—	35 lbs.	3.9	
	88NA182422TRTVW Wood 3mm Rim	1591			18	24	22	—	—	27 lbs.	3.9	
	88NA182422TRTVLW Laminate 3mm Rim	1318			18	24	22	—	—	27 lbs.	3.9	

- Ships as one unit (KD)
- All models except for the wood and laminate 3mm have a reversed half-bullnose rim detail

WIXLER OCCASIONAL TABLES

PRODUCT SPECIFICATIONS

- Wood, laminate, glass, and solid surface available. See page 523 for options
- Legs are solid wood. See page 523 for color options
- Legs shipped in same box as top (KD)
- Wood and laminate have a plywood core with exposed rim detail. Glass has plywood core, but not exposed
- Wood and laminate available with standard core with 3mm edge detail

TO ORDER, SPECIFY:

1. Model Number
2. Laminate/Wood Color
3. Solid Surface Grade (Solid surface only)
4. Solid Surface Color (Solid surface only)
5. Leg Finish

SAMPLE MODEL NUMBER:

88NA304816TTRLW 488 402

- See page 523 for all options available in Occasional Tables

	MODEL NO./DESCRIPTION	LIST PRICE			DIMENSIONS					CARTONED CUBIC		
		GRADE A	GRADE B	GRADE C	D	W	H	A	KW	WEIGHT	FEET	
	30" X 48"											
	88NA304816TTRW	Wood	\$ 2020			30	48	16	—	—	45 lbs.	15.0
	88NA304816TTRLW	Laminate	2020			30	48	16	—	—	45 lbs.	15.0
	88NA304816TTRGW	White Back Painted Glass	3565			30	48	16	—	—	78 lbs.	15.0
	88NA304816TTRSW	Solid Surface	4012	4293	4662	30	48	16	—	—	62 lbs.	15.0
	88NA304816TTRVW	Wood 3mm Rim	1592			30	48	16	—	—	45 lbs.	15.0
	88NA304816TTRVLW	Laminate 3mm Rim	1319			30	48	16	—	—	45 lbs.	15.0
	<hr/>											
	88NA304818TTRW	Wood	\$ 2049			30	48	18	—	—	46 lbs.	9.0
	88NA304818TTRLW	Laminate	2049			30	48	18	—	—	46 lbs.	9.0
	88NA304818TTRGW	White Back Painted Glass	3593			30	48	18	—	—	79 lbs.	9.0
	88NA304818TTRSW	Solid Surface	4040	4321	4690	30	48	18	—	—	63 lbs.	9.0
	88NA304818TTRVW	Wood 3mm Rim	1620			30	48	18	—	—	46 lbs.	9.0
	88NA304818TTRVLW	Laminate 3mm Rim	1347			30	48	18	—	—	46 lbs.	9.0
	<hr/>											
	24" X 36"											
	88NA243616TTRW	Wood	\$ 1798			24	36	16	—	—	31 lbs.	5.8
	88NA243616TTRLW	Laminate	1798			24	36	16	—	—	31 lbs.	5.8
88NA243616TTRGW	White Back Painted Glass	3001			24	36	16	—	—	52 lbs.	5.8	
88NA243616TTRSW	Solid Surface	3562	3730	3951	24	36	16	—	—	42 lbs.	5.8	
88NA243616TTRVW	Wood 3mm Rim	1483			24	36	16	—	—	31 lbs.	5.8	
88NA243616TTRVLW	Laminate 3mm Rim	1211			24	36	16	—	—	31 lbs.	5.8	
<hr/>												
88NA243618TTRW	Wood	\$ 1826			24	36	18	—	—	32 lbs.	11.0	
88NA243618TTRLW	Laminate	1826			24	36	18	—	—	32 lbs.	11.0	
88NA243618TTRGW	White Back Painted Glass	3029			24	36	18	—	—	53 lbs.	11.0	
88NA243618TTRSW	Solid Surface	3591	3759	3980	24	36	18	—	—	43 lbs.	11.0	
88NA243618TTRVW	Wood 3mm Rim	1511			24	36	18	—	—	32 lbs.	11.0	
88NA243618TTRVLW	Laminate 3mm Rim	1239			24	36	18	—	—	32 lbs.	11.0	

- Ships as one unit (KD)
- All models except for the wood and laminate 3mm have a reversed half-bullnose rim detail

WIXLER OCCASIONAL TABLES

PRODUCT SPECIFICATIONS

- Wood, laminate, glass, and solid surface available. See page 523 for options
- Upholstered top available. See pages 10-17 for fabric options
- Legs are solid wood. See page 523 for color options
- Legs shipped in same box as top (KD)
- Wood and laminate have a plywood core with exposed rim detail. Glass has plywood core, but not exposed
- Wood and laminate available with standard core with 3mm edge detail

TO ORDER, SPECIFY:

1. Model Number
2. Laminate/Wood Color
3. Solid Surface Grade (Solid surface only)
4. Solid Surface Color (Solid surface only)
5. Leg Finish

SAMPLE MODEL NUMBER:

88NA284816TPRLW 488 402

- See page 523 for all options available in Occasional Tables

	MODEL NO./DESCRIPTION	LIST PRICE			DIMENSIONS					CARTONED CUBIC	
		GRADE A	GRADE B	GRADE C	D	W	H	A	KW	WEIGHT	FEET
PEAR TOP 	28" X 48"										
	88NA284816TPRW Wood	\$ 2077			28	48	16	—	—	47 lbs.	8.5
	88NA284816TPRLW Laminate	2077			28	48	16	—	—	47 lbs.	8.5
	88NA284816TPRGW White Back Painted Glass	3621			28	48	16	—	—	83 lbs.	8.5
	88NA284816TPRSW Solid Surface	4069	4333	4679	28	48	16	—	—	66 lbs.	8.5
	88NA284816TPRVW Wood 3mm Rim	1649			28	48	16	—	—	47 lbs.	8.5
	88NA284816TPRVLW Laminate 3mm Rim	1376			28	48	16	—	—	47 lbs.	8.5
	88NA284818TPRW Wood	\$ 2105			28	48	18	—	—	48 lbs.	8.5
	88NA284818TPRLW Laminate	2105			28	48	18	—	—	48 lbs.	8.5
	88NA284818TPRGW White Back Painted Glass	3650			28	48	18	—	—	84 lbs.	8.5
	88NA284818TPRSW Solid Surface	4097	4361	4707	28	48	18	—	—	67 lbs.	8.5
	88NA284818TPRVW Wood 3mm Rim	1677			28	48	18	—	—	48 lbs.	8.5
	88NA284818TPRVLW Laminate 3mm Rim	1404			28	48	18	—	—	48 lbs.	8.5
	24" X 36"										
	88NA243616TPRW Wood	\$ 1854			24	36	16	—	—	32 lbs.	5.8
	88NA243616TPRLW Laminate	1854			24	36	16	—	—	32 lbs.	5.8
	88NA243616TPRGW White Back Painted Glass	3058			24	36	16	—	—	54 lbs.	5.8
	88NA243616TPRSW Solid Surface	3619	3787	4008	24	36	16	—	—	44 lbs.	5.8
88NA243616TPRVW Wood 3mm Rim	1426			24	36	16	—	—	32 lbs.	5.8	
88NA243616TPRVLW Laminate 3mm Rim	1199			24	36	16	—	—	32 lbs.	5.8	
88NA243618TPRW Wood	\$ 1883			24	36	18	—	—	33 lbs.	5.8	
88NA243618TPRLW Laminate	1883			24	36	18	—	—	33 lbs.	5.8	
88NA243618TPRGW White Back Painted Glass	3086			24	36	18	—	—	55 lbs.	5.8	
88NA243618TPRSW Solid Surface	3648	3816	4037	24	36	18	—	—	45 lbs.	5.8	
88NA243618TPRVW Wood 3mm Rim	1454			24	36	18	—	—	33 lbs.	5.8	
88NA243618TPRVLW Laminate 3mm Rim	1227			24	36	18	—	—	33 lbs.	5.8	

- Ships as one unit (KD)
- All models except for the wood and laminate 3mm have a reversed half-bullnose rim detail

