OCCASIONAL TABLES

Arrowood	488
Barrington	489
Confide	490
Eloquence	491
Epic	492
Escalade	493
Farrah	494
Footings	495
Marnia	496
Myriad	500
Reno	505
Roosevelt	507
Staccato	508
Swift	512
Tag	514
Tessera	515
Universal	516
Wixler	522

ARROWOOD OCCASIONAL TABLES



Shaded model numbers are available on our "To You in 10 Days or Less" Quick Delivery program and will be delivered in 10 days or less.

TO ORDER, SPECIFY:

1. Model Number
2. Finish/Laminate Color

SAMPLE MODEL NUMBER:

31N2040MGLW HN

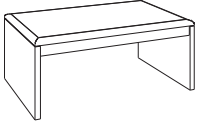
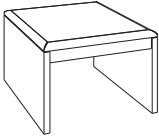
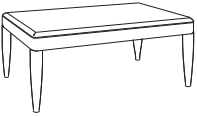
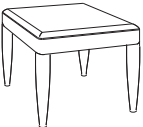
	MODEL NO./DESCRIPTION	LIST PRICE	DIMENSIONS					CARTONED CUBIC	
			D	W	H	A	KW	WEIGHT	FEET
ARROWOOD MAGAZINE TABLE PANEL LEGS 	31N2040MGLW HPL Top	\$ 800	19 ³ / ₄	39 ¹ / ₂	16	¹ / ₄	—	67 lbs.	12.2
	<ul style="list-style-type: none"> • Reference Arrowood for detailed product information, finishes and entire Arrowood offering starting on page 38 in the Casegoods Book 1 Price List 								
ARROWOOD END TABLE PANEL LEGS 	31N2424ENLW HPL Top	\$ 728	23 ³ / ₄	23 ¹ / ₂	19	¹ / ₄	—	63 lbs.	11.0
	<ul style="list-style-type: none"> • Reference Arrowood for detailed product information, finishes and entire Arrowood offering starting on page 38 in the Casegoods Book 1 Price List 								
ARROWOOD MAGAZINE TABLE TURNED LEGS 	Q31N2040MGPLW HPL Top	\$ 1159	19 ²⁵ / ₃₂	39 ²⁵ / ₃₂	17 ⁷ / ₁₆	—	—	42 lbs.	3.0
	31N2040MGPLW HPL Top	1159	19 ²⁵ / ₃₂	39 ²⁵ / ₃₂	17 ⁷ / ₁₆	—	—	42 lbs.	3.0
	<ul style="list-style-type: none"> • Some assembly required • Reference Arrowood for detailed product information, finishes and entire Arrowood offering starting on page 38 in the Casegoods Book 1 Price List 								
ARROWOOD END TABLE TURNED LEGS 	Q31N2424ENPLW HPL Top	\$ 1085	23 ²⁵ / ₃₂	23 ²⁵ / ₃₂	20 ⁷ / ₁₆	—	—	33 lbs.	2.2
	31N2424ENPLW HPL Top	1085	23 ²⁵ / ₃₂	23 ²⁵ / ₃₂	20 ⁷ / ₁₆	—	—	33 lbs.	2.2
	<ul style="list-style-type: none"> • Some assembly required • Reference Arrowood for detailed product information, finishes and entire Arrowood offering starting on page 38 in the Casegoods Book 1 Price List 								

BARRINGTON OCCASIONAL TABLES



Shaded model numbers are available on our "To You in 10 Days or Less" Quick Delivery program and will be delivered in 10 days or less.

TO ORDER, SPECIFY:

1. Model Number
2. Finish/Laminate Color

SAMPLE MODEL NUMBERS:

50N2040MGW DW
50N2040MGQW MH

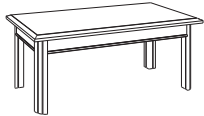
	MODEL NO./DESCRIPTION	LIST PRICE	DIMENSIONS					CARTONED CUBIC	
			D	W	H	A	KW	WEIGHT	FEET
BARRINGTON MAGAZINE TABLE 	Q50N2040MGW Wood Top	\$ 1117	19 $\frac{3}{4}$	39 $\frac{3}{4}$	18 $\frac{3}{16}$	—	—	42 lbs.	3.0
	50N2040MGW Wood Top	1117	19 $\frac{3}{4}$	39 $\frac{3}{4}$	18 $\frac{3}{16}$	—	—	42 lbs.	3.0
	50N2040MGLW HPL Top	969	19 $\frac{3}{4}$	39 $\frac{3}{4}$	18 $\frac{3}{16}$	—	—	42 lbs.	3.0

- Some assembly required
- HPL top tables have veneer legs/bases
- Reference Barrington for detailed product information, finishes and entire Barrington offering starting on page 60 in the Casegoods Book 1 Price List

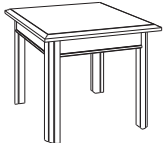
BARRINGTON END TABLE 	Q50N2424ENW Wood Top	\$ 983	23 $\frac{3}{4}$	23 $\frac{3}{4}$	22 $\frac{3}{16}$	—	—	38 lbs.	2.8
	50N2424ENW Wood Top	983	23 $\frac{3}{4}$	23 $\frac{3}{4}$	22 $\frac{3}{16}$	—	—	38 lbs.	2.8
	50N2424ENLW HPL Top	863	23 $\frac{3}{4}$	23 $\frac{3}{4}$	22 $\frac{3}{16}$	—	—	38 lbs.	2.8

- Some assembly required
- HPL top tables have veneer legs/bases
- Reference Barrington for detailed product information, finishes and entire Barrington offering starting on page 60 in the Casegoods Book 1 Price List

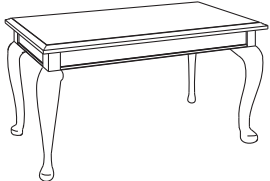
BARRINGTON QUEEN ANNE MAGAZINE TABLE 	50N2040MGQW Wood Top	\$ 1541	19 $\frac{3}{4}$	39 $\frac{3}{4}$	18 $\frac{3}{16}$	—	—	36 lbs.	3.0
---	----------------------	---------	------------------	------------------	-------------------	---	---	---------	-----

- Some assembly required
- Reference Barrington for detailed product information, finishes and entire Barrington offering starting on page 60 in the Casegoods Book 1 Price List

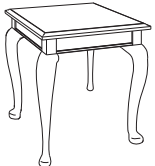
BARRINGTON QUEEN ANNE END TABLE 	50N2424ENQW Wood Top	\$ 1451	23 $\frac{3}{4}$	23 $\frac{3}{4}$	22 $\frac{3}{16}$	—	—	32 lbs.	3.3
---	----------------------	---------	------------------	------------------	-------------------	---	---	---------	-----

- Some assembly required
- Reference Barrington for detailed product information, finishes and entire Barrington offering starting on page 60 in the Casegoods Book 1 Price List

CONFIDE OCCASIONAL TABLES

TO ORDER, SPECIFY:

1. Model Number
2. Finish/Laminate Color
3. Metal Color

SAMPLE MODEL NUMBER:

N78SNW MC 462

	MODEL NO./DESCRIPTION	LIST PRICE	DIMENSIONS					CARTONED WEIGHT	CUBIC FEET
			D	W	H	A	KW		
CONFIDE END TABLE	N78SNW Wood	\$ 1174	21¼	22	16½	—	—	15 lbs.	6.8
	N78SNL Laminate	1174	21¼	22	16½	—	—	15 lbs.	6.8



- Soft glide option available for a \$30 list upcharge
- Reference Confide for detailed product information, finishes and entire Confide offering starting on page 94 in the Seating Price List

CONFIDE MAGAZINE TABLE	N78SMW Wood	\$ 1826	21¼	44	16½	—	—	24 lbs.	14.2
	N78SML Laminate	1826	21¼	44	16½	—	—	24 lbs.	14.2

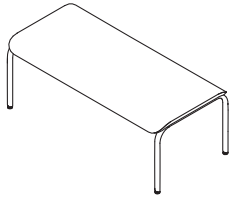

- Soft glide option available for a \$30 list upcharge
- Reference Confide for detailed product information, finishes and entire Confide offering starting on page 94 in the Seating Price List

ELOQUENCE OCCASIONAL TABLES

TO ORDER, SPECIFY:

- 1. Model Number
- 2. Finish/Laminate Color

SAMPLE MODEL NUMBER:

85N2024EN CL

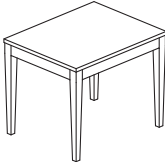

MODEL NO./DESCRIPTION	LIST PRICE	DIMENSIONS				A	KW	CARTONED WEIGHT	CUBIC FEET
		D	W	H					
85N2024EN Wood Top	\$ 950	24 ⁷ / ₁₆	21 ¹ / ₂	20 ¹ / ₈	—	—	19 lbs.	1.4	
85N2024ENLW Laminate Top	950	24 ⁷ / ₁₆	21 ¹ / ₂	20 ¹ / ₈	—	—	19 lbs.	1.4	

- Some assembly required
- Reference Eloquence for detailed product information, finishes and entire Eloquence offering starting on page 154 in the Seating Price List

ELOQUENCE MAGAZINE TABLE

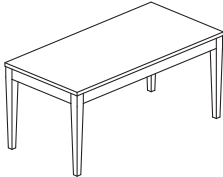

85N2040MG Wood Top	\$ 1092	19 ² / ₃₂	39 ⁷ / ₈	18 ³ / ₃₂	—	—	26 lbs.	2.2
85N2040MGLW Laminate Top	1092	19 ² / ₃₂	39 ⁷ / ₈	18 ³ / ₃₂	—	—	26 lbs.	2.2

- Some assembly required
- Reference Eloquence for detailed product information, finishes and entire Eloquence offering starting on page 154 in the Seating Price List

OCCASIONAL TABLES

EPIC OCCASIONAL TABLES

TO ORDER, SPECIFY:

1. Model Number
2. Surface Grommet
3. Side Grommet
4. Paint
5. Finish/Laminate Color

SAMPLE MODEL NUMBER:

25N2424ENW X X 462 MC

	MODEL NO./DESCRIPTION	LIST PRICE	DIMENSIONS					CARTONED CUBIC	
			D	W	H	A	KW	WEIGHT	FEET
EPIC END TABLE	25N2424ENW Wood	\$ 1661	24	24	18 $\frac{3}{8}$	—	—	55 lbs.	12.6
	25N2424ENL Laminate	1441	24	24	18 $\frac{3}{8}$	—	—	55 lbs.	12.6

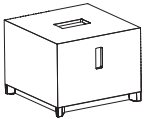
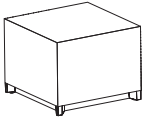

Optional Surface and Side Grommet Locations

- Features metal base and feet in 3 color options
- Optional surface grommet cutout available in G12, G17, and G23 cutout (+\$25 list)
- Optional side grommet cutout available in G23 cutout (+\$25 list)
- Power grommet sold separately; reference pages 547-549, 554-557, and 560 for pricing and details
- Optional glass and solid surface kits available; reference page 520
- Reference Epic for detailed product information, finishes and entire Epic offering starting on page 94 in the Casegoods Book 2 Price List

EPIC MAGAZINE TABLE	25N2448MGW Wood	\$ 1779	24	48	14 $\frac{3}{4}$	—	—	77 lbs.	19.1
	25N2448MGL Laminate	1567	24	48	14 $\frac{3}{4}$	—	—	77 lbs.	19.1

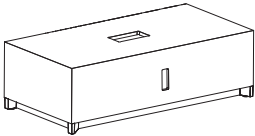
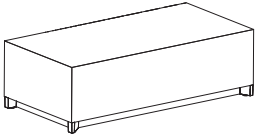

Optional Surface and Side Grommet Locations

- Features metal base and feet in 3 color options
- Optional surface grommet cutout available in G12, G17, and G23 cutout (+\$25 list)
- Optional side grommet cutout available in G23 cutout (+\$25 list)
- Power grommet sold separately; reference pages 547-549, 554-557, and 560 for pricing and details
- Optional glass and solid surface kits available; reference page 520
- Reference Epic for detailed product information, finishes and entire Epic offering starting on page 94 in the Casegoods Book 2 Price List

EPIC COFFEE TABLE	25N3636MGW Wood	\$ 1851	36	36	14 $\frac{1}{16}$	—	—	65 lbs.	15.0
	25N3636MGL Laminate	1640	36	36	14 $\frac{1}{16}$	—	—	65 lbs.	15.0

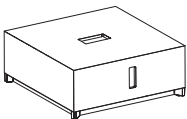
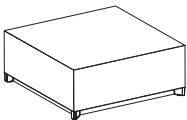

Optional Surface and Side Grommet Locations

- Features metal base and feet in 3 color options
- Optional surface grommet cutout available in G12, G17, and G23 cutout (+\$25 list)
- Optional side grommet cutout available in G23 cutout (+\$25 list)
- Power grommet sold separately; reference pages 547-549, 554-557, and 560 for pricing and details
- Optional glass and solid surface kits available; reference page 520
- Reference Epic for detailed product information, finishes and entire Epic offering starting on page 94 in the Casegoods Book 2 Price List

ESCALADE OCCASIONAL TABLES





Shaded model numbers are available on our "To You in 10 Days or Less" Quick Delivery program and will be delivered in 10 days or less.

TO ORDER, SPECIFY:

1. Model Number
2. Finish

SAMPLE MODEL NUMBER:

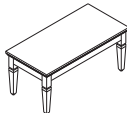
ECN2040MGW MC

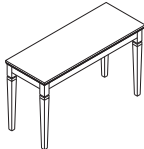
	MODEL NO./DESCRIPTION	LIST PRICE	DIMENSIONS					CARTONED CUBIC	
			D	W	H	A	KW	WEIGHT	FEET
ESCALADE MAGAZINE TABLE 	QECN2040MGW	\$ 1571	19¾	39¾	18	—	—	70 lbs.	4.3
	ECN2040MGW	\$ 1571	19¾	39¾	18	—	—	70 lbs.	4.3
	<ul style="list-style-type: none"> • Reference Escalade for detailed product information, finishes and entire Escalade offering starting on page 82 in the Casegoods Book 1 Price List 								
ESCALADE END TABLE 	QECN2424ENW	\$ 1475	23 ¹ / ₁₆	23 ¹ / ₁₆	24	—	—	40 lbs.	3.9
	ECN2424ENW	1475	23 ¹ / ₁₆	23 ¹ / ₁₆	24	—	—	40 lbs.	3.9
	<ul style="list-style-type: none"> • Reference Escalade for detailed product information, finishes and entire Escalade offering starting on page 82 in the Casegoods Book 1 Price List 								
ESCALADE CONSOLE TABLE 	ECN1948CSW	\$ 1756	18 ⁷ / ₁₆	48	28½	—	—	85 lbs.	4.9
	<ul style="list-style-type: none"> • Rim detail on 3 sides of unit • Reference Escalade for detailed product information, finishes and entire Escalade offering starting on page 82 in the Casegoods Book 1 Price List 								

FARRAH OCCASIONAL TABLES

TO ORDER, SPECIFY:

1. Model Number
2. Wood/Laminate Finish (when applicable)
3. Solid Surface Grade/Color (when applicable)
4. Frame Color (when applicable)
5. Glides (when applicable)

SAMPLE MODEL NUMBERS:

N71T2525ENL CW 462 STD
N71T2525ENS C 7302 462 STD

FARRAH END TABLE

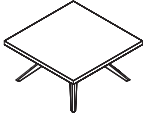

MODEL NO./DESCRIPTION	LIST PRICE		DIMENSIONS					CARTONED WEIGHT	CUBIC FEET
	GRADE A	GRADE C	D	W	H	A	KW		
N71T2525ENL Laminate	\$ 1507		25	25	14	—	—	64 lbs.	10.4
N71T2525ENDLW Laminate - Exposed Plywood Rim	1681		25	25	14	—	—	64 lbs.	10.4
N71T2525ENW Veneer	1796		25	25	14	—	—	64 lbs.	10.4
N71T2525ENDW Veneer - Exposed Plywood Rim	1970		25	25	14	—	—	64 lbs.	10.4
N71T2525ENS Solid Surface	2520	2798	25	25	14	—	—	71 lbs.	10.4

• Reference Farrah for detailed product information, finishes and entire Farrah offering starting on page 180 in the Seating Price List

FARRAH MAGAZINE TABLE

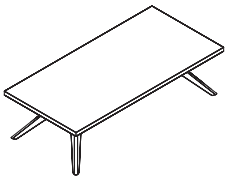

MODEL NO./DESCRIPTION	LIST PRICE		DIMENSIONS					CARTONED WEIGHT	CUBIC FEET
	GRADE A	GRADE C	D	W	H	A	KW		
N71T2552MGL Laminate	\$ 1970		51½	24½	14	—	—	112 lbs.	19.7
N71T2552MGDLW Laminate - Exposed Plywood Rim	2143		51½	24½	14	—	—	112 lbs.	19.7
N71T2552MGW Veneer	2260		51½	24½	14	—	—	112 lbs.	19.7
N71T2552MGDW Veneer - Exposed Plywood Rim	2434		51½	24½	14	—	—	112 lbs.	19.7
N71T2552MGS Solid Surface	3359	3931	51½	24½	14	—	—	126 lbs.	19.7

• Reference Farrah for detailed product information, finishes and entire Farrah offering starting on page 180 in the Seating Price List

FARRAH GANGING CENTER TABLE

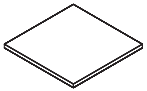

MODEL NO./DESCRIPTION	LIST PRICE		DIMENSIONS					CARTONED WEIGHT	CUBIC FEET
	GRADE A	GRADE C	D	W	H	A	KW		
N71TCL Laminate	\$ 463		25	25	14	—	—	24.5 lbs.	1.5
N71TCDLW Laminate - Exposed Plywood Rim	522		25	25	14	—	—	24.5 lbs.	1.5
N71TCW Veneer	754		25	25	14	—	—	24.5 lbs.	1.5
N71TCDW Veneer - Exposed Plywood Rim	811		25	25	14	—	—	24.5 lbs.	1.5
N71TCS Solid Surface	1389	1667	25	25	14	—	—	31.5 lbs.	1.5

• 2 metal attachment brackets and hardware included

• Reference Farrah for detailed product information, finishes and entire Farrah offering starting on page 180 in the Seating Price List

FOOTINGS OCCASIONAL TABLES

TO ORDER, SPECIFY:

1. Model Number
2. Paint Color
3. Foot Paint Color

SAMPLE MODEL NUMBER:

CBV245015YBKP 265 265

	MODEL NO./DESCRIPTION	LIST PRICE	DIMENSIONS					KW	CARTONED WEIGHT	CUBIC FEET
			D	W	H	A				
FOOTINGS X BASE OCCASIONAL HEIGHT	CBV2115XBP	\$ 406	20 ⁹ / ₁₆	20 ⁹ / ₁₆	14 ¹ / ₁₆	—	—	26 lbs.	4.2	
	CBV2715XBP	458	27 ¹ / ₄	27 ¹ / ₄	14 ¹ / ₁₆	—	—	28 lbs.	6.3	
	CBV3215XBP	510	31 ¹ / ₁₆	31 ¹ / ₁₆	14 ¹ / ₁₆	—	—	28 lbs.	7.9	

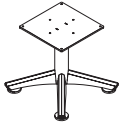

- 1¹/₈" diameter glide
- Reference Footings for detailed product information, finishes and entire Footings offering starting on page 182

FOOTINGS X BASE END TABLE HEIGHT	CBV2119XBP	\$ 434	20 ⁹ / ₁₆	20 ⁹ / ₁₆	18	—	—	28 lbs.	5.1
	CBV2719XBP	463	27 ¹ / ₄	27 ¹ / ₄	18	—	—	29 lbs.	7.8

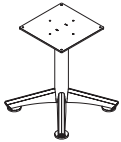

- Reference Footings for detailed product information, finishes and entire Footings offering starting on page 182

FOOTINGS Y BASES WITH RAIL OCCASIONAL HEIGHT	CBV183115YBKP	\$ 639	30 ³ / ₁₆	18 ¹ / ₁₆	14 ¹ / ₁₆	—	—	49 lbs.	7.1
	CBV183515YBKP	667	34 ⁷ / ₁₆	18 ¹ / ₁₆	14 ¹ / ₁₆	—	—	49 lbs.	7.2
	CBV243815YBKP	696	38 ⁵ / ₁₆	24	14 ¹ / ₁₆	—	—	51 lbs.	9.8
	CBV244415YBKP	725	44 ⁵ / ₁₆	24	14 ¹ / ₁₆	—	—	52 lbs.	9.8
	CBV245015YBKP	754	50 ⁵ / ₁₆	24	14 ¹ / ₁₆	—	—	52 lbs.	9.8



- 1¹/₈" diameter glide
- Reference Footings for detailed product information, finishes and entire Footings offering starting on page 182

MARNIA OCCASIONAL TABLES

PRODUCT SPECIFICATIONS

TOPS

- Laminate surfaces are 1" HPL (high pressure laminate)
- Veneer surfaces are 1" plain sliced slipmatched cherry (Amber, Autumn, Mocha, Truffle) or maple veneer (Brighton, Caramel, Honey, Natural), plain sliced bookmatched walnut veneer (Clear Walnut, Cordovan, Judicial), quarter cut walnut veneer (Almond, Portobello, Sable), or quarter cut oak veneer (Sonoma)
- When specifying Clear Walnut, a clear coat finish, the natural wood characteristics of walnut veneer are visible. These characteristics include, but are not limited to, color and woodgrain variation.
- Solid surface is 1" thick
- Back painted glass surfaces (round tops only) have a 1" thick top including the glass and white substrate
- Grain direction runs parallel to the metal frame on square and rectangle models

RIM PROFILES

- Veneer models have a matching 3mm veneer edge band
- Laminate models have a matching 3mm PVC edge band
- Back painted glass has a MDF core with thermofoil edge
- Solid surface worksurface have a matching 3mm radius edge

UPHOLSTERED TOPS

- $\frac{3}{4}$ " high grade polyurethane foam covers a $\frac{3}{4}$ " solid base panel

LEGS

- 2 metal base styles; the round tables will have an "X" base for the 30" and 40" models and a "Y" base for the 16" and 24" diameter models, the square and rectangles will have an open style base

FINISH APPLICATION

- Finish is a water based, high performance wood finish that meets or exceeds indoor air quality standards. This proprietary finish is virtually VOC-free, has remarkable durability, and allows the beauty of the wood to show through
- Surfaces feature a semi-open pore matte finish

**TOP
WOOD FINISHES**

AC	Autumn
AD	Almond
CL	Caramel
CW	Cordovan
DW	Judicial
EW	Clear Walnut*
HN	Honey
IM	Brighton
MC	Amber
MH	Mocha
NM	Natural
PB	Portobello
SM	Sonoma
TF	Truffle
792	Sable

TOP LAMINATE COLORS

WOODGRAIN LAMINATE

AC2	Autumn 2
AD	Almond
CL	Caramel
CW	Cordovan
DW	Judicial
HN2	Honey 2
IM	Brighton
MC	Amber
MH	Mocha
NM	Natural
PB	Portobello
PT	Portico
SK	Skyline
SM	Sonoma
TF	Truffle
792	Sable
793	Acorn*

*Acorn is the laminate complement to Clear Walnut finish

SOLID LAMINATE

405	Designer White
419	Wallaby
425	Shadow
440	Cloud
461	Graphite
462	Cinder
478	Platinum Grey
488	Frosty White
491	Designer White Linear
492	Cinder Linear

GALLERY LAMINATE

Grade 1 – 5% upcharge	
G1001	Citadel
G1011	Pepperdust
Grade 2 – 6% upcharge	
G1002	Planked Raw Oak
G1003	Evening Notte
G1004	Kirsche
G1005	Midnight Run
G1006	Sepia Walnut
G1007	Serotina
G1008	Timeless
G1009	White Nebbia
G1012	Phantom Ecru

See page 18 for Gallery program details and upcharges

**LEG
PAINT COLORS**

405	Designer White
423	Concrete
462	Cinder
463	Iron
501	Platinum Metallic
503	Satin Nickel Metallic

SOLID SURFACE TOP OPTIONS

COLORS

7101	Bisque (Grade A)
7201	Glacier White (Grade A)
7202	Canyon (Grade B)
7203	Designer White (Grade B)
7204	Silt (Grade B)
7301	Concrete (Grade C)
7302	Deep Night Sky (Grade C)
7303	Deep Nocturne (Grade C)

RIM PROFILE

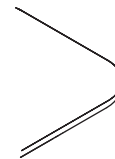

MARNIA OCCASIONAL TABLES

PRODUCT SPECIFICATIONS

- Wood, Laminate, Glass, and Solid Surface worksurface available on round tops. See page 497 for options
- Upholstered top available for 16" round table only. See pages 10-17 for fabric options
- Legs are metal. See page 497 for color options
- Round tops are shipped KD

TO ORDER, SPECIFY:

1. Model Number
2. Wood Finish/Laminate Color
3. Solid Surface Grade/Color
4. Leg Paint Color

SAMPLE MODEL NUMBERS:

89N2422TRDW PB 463
89N2422TRDS C 7305 463

- See page 497 for all options available in Occasional Tables

MODEL NO./DESCRIPTION	LIST PRICE				DIMENSIONS					CARTONED CUBIC		
	GRADE A	GRADE B	GRADE C	D	W	H	A	KW	WEIGHT	FEET		
ROUND TABLE	16" ROUND				DI	H						
	89N1616TRDL	Laminate	\$ 1223		16	—	16	—	—		2.7	
	89N1616TRDG	White Back Painted Glass	1513		16	—	16	—	—		2.7	
	89N1616TRDS	Solid Surface	1682	1732	1797	16	—	16	—	—	2.7	
		Grade	1	2/COM	3/COL	4	5	6	7	L7	L8	
	89N1616TRDF	Fabric	\$ 1492	1511	1519	1533	1547	1573	1606	1766	1818	

ALLIANCE GRADE / LIST PRICE

	A	B	C	D	E	F	G	H	I	J
\$	1524	1542	1557	1573	1591	1610	1624	1643	1663	1681
	K	L	M	N	O	P	Q	R	S	T
\$	1711	1771	1808	1828	1848	1867	1887	1905	1925	1944

DIMENSIONS

Diameter 16
Height 16½" Cubic Ft. 2.7

- Veneer top is not an option on 16" round tops
- See fabric guidelines on page 14 of the Tables Price List
- Ships KD in 2 cartons

ROUND TABLE

MODEL NO./DESCRIPTION	GRADE A	GRADE B	GRADE C	DI	H					
24" ROUND										
89N2422TRDW	Wood	\$ 1876		24	—	22	—	—		6.0
89N2422TRDL	Laminate	1444		24	—	22	—	—		6.0
89N2422TRDG	White Back Painted Glass	2072		24	—	22	—	—		6.0
89N2422TRDS	Solid Surface	2252	2364	2508	24	—	22	—	—	6.0
30" ROUND										
89N3016TRDW	Wood	\$ 2058		30½	—	16	—	—		5.7
89N3016TRDL	Laminate	1715		30½	—	16	—	—		5.7
89N3016TRDG	White Back Painted Glass	2641		30½	—	16	—	—		5.7
89N3016TRDS	Solid Surface	2779	2954	3179	30½	—	16	—	—	5.7
40" ROUND										
89N4016TRDW	Wood	\$ 2707		40	—	16	—	—		12.6
89N4016TRDL	Laminate	2256		40	—	16	—	—		12.6
89N4016TRDG	White Back Painted Glass	3781		40	—	16	—	—		12.6
89N4016TRDS	Solid Surface	3898	4209	4608	40	—	16	—	—	12.6

- Ships KD in 2 cartons



MARNIA OCCASIONAL TABLES

PRODUCT SPECIFICATIONS

- Wood, Laminate, and Solid Surface available on square tops. See page 497 for options
- Legs are metal. See page 497 for color options
- Square and Rectangular tops shipped assembled
- Wood and Laminate tops have 3mm edge

TO ORDER, SPECIFY:

1. Model Number
2. Wood Finish/Laminate Color
3. Solid Surface Grade/Color
4. Leg Paint Color

SAMPLE MODEL NUMBERS:

89N242422TSQW PB 463
89N182722TRTW PB 463

- See page 497 for all options available in Occasional Tables

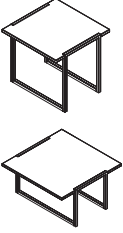
SQUARE TABLE	MODEL NO./DESCRIPTION	LIST PRICE			DIMENSIONS					CARTONED WEIGHT	CUBIC FEET
		GRADE A	GRADE B	GRADE C	D	W	H	A	KW		
	24" SQUARE										
	89N242422TSQW	Wood	\$ 2140			24	24	22	–	–	12.7
	89N242422TSQL	Laminate	1646			24	24	22	–	–	12.7
	89N242422TSQS	Solid Surface	2569	2681	2825	24	24	22	–	–	12.7
	30" SQUARE										
	89N303016TSQW	Wood	\$ 2088			30%	30%	16	–	–	14.2
	89N303016TSQL	Laminate	1671			30%	30%	16	–	–	14.2
	89N303016TSQS	Solid Surface	2819	2994	3219	30%	30%	16	–	–	14.2
	40" SQUARE										
89N404016TSQW	Wood	\$ 2461			40	40	16	–	–	23.4	
89N404016TSQL	Laminate	2050			40	40	16	–	–	23.4	
89N404016TSQS	Solid Surface	3690	4001	4400	40	40	16	–	–	23.4	

- Tops have cutouts to accept base. On laminate models, cutout will always be painted black. On Veneer models, cutout will match finish specified

RECTANGLE TABLE

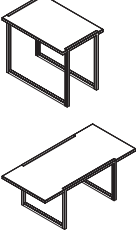
RECTANGLE TABLE	MODEL NO./DESCRIPTION	LIST PRICE			DIMENSIONS					CARTONED WEIGHT	CUBIC FEET
		GRADE A	GRADE B	GRADE C	D	W	H	A	KW		
	18" x 27" RECTANGLE										
	89N182722TRTW	Wood	\$ 2000			18	27	22	–	–	11.1
	89N182722TRTL	Laminate	1538			18	27	22	–	–	11.1
	89N182722TRTS	Solid Surface	2400	2495	2618	18	27	22	–	–	11.1
	20" x 42" RECTANGLE										
	89N204216TRTW	Wood	\$ 2055			20	42	16	–	–	13.6
	89N204216TRTL	Laminate	1644			20	42	16	–	–	13.6
	89N204216TRTS	Solid Surface	2775	2937	3146	20	42	16	–	–	13.6

- Tops have cutouts to accept base. On laminate models, cutout will always be painted black. On Veneer models, cutout will match finish specified

MYRIAD OCCASIONAL TABLES

BOX AND FLOATING TOP SIZES

End Table 24" x 24"
 Coffee Table 36" x 36"
 Magazine Table 24" x 48"
 Console Table 18" x 50"

CUBE SIZES

End Table 24" x 24"
 Coffee Table 36" x 36"
 Magazine Table 24" x 48"

CYLINDER SIZES

End Table 24" Diameter
 Coffee Table 36" Diameter

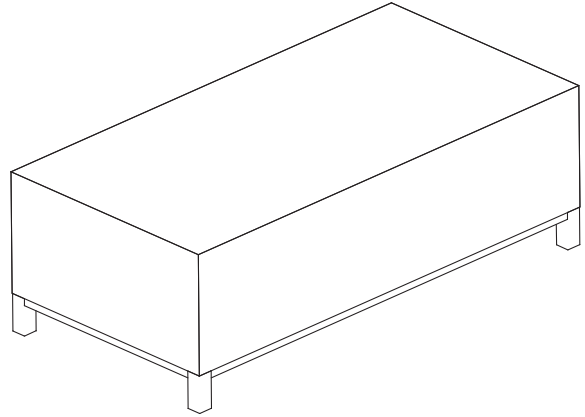

GLASS TOP KITS AVAILABLE FOR

Box styles
 Cube styles
 Cylinder styles

WOOD FINISHES

AC Autumn
 CL Caramel
 CW Cordovan
 DW Judicial
 HN Honey
 IM Brighton
 MC Amber
 MH Mocha
 NM Natural
 TF Truffle

- Veneer tables are plain sliced slipmatched cherry (Amber, Autumn, Mocha, Truffle), maple veneer (Brighton, Caramel, Honey, Natural), or plain sliced bookmatched walnut veneer (Cordovan, Judicial)

LAMINATES

WOODGRAIN LAMINATE

AC2 Autumn 2
 AD Almond
 CL Caramel
 CW Cordovan
 DW Judicial
 HN2 Honey 2
 IM Brighton
 MC Amber
 MH Mocha
 NM Natural
 PB Portobello
 PT Portico
 SK Skyline
 SM Sonoma
 TF Truffle
 792 Sable
 793 Acorn

SOLID LAMINATE

405 Designer White
 419 Wallaby
 425 Shadow
 440 Cloud
 461 Graphite
 462 Cinder
 478 Platinum Grey
 488 Frosty White
 491 Designer White Linear
 492 Cinder Linear

PATTERN LAMINATE

814 White Tigris
 818 Crisp Linen
 819 Flax Gauze
 821 Elemental Concrete
 822 Smoke Quarstone
 874 Bronze Legacy

GALLERY LAMINATE

Grade 1 – 5% upcharge
 G1001 Citadel
 G1011 Pepperdust
 Grade 2 – 6% upcharge
 G1002 Planked Raw Oak
 G1003 Evening Notte
 G1004 Kirsche
 G1005 Midnight Run
 G1006 Sepia Walnut
 G1007 Serotina
 G1008 Timeless
 G1009 White Nebbia
 G1012 Phantom Ecru

See page 18 for Gallery program details and upcharges

FINISH APPLICATION

- Finish is a water-based, high performance wood finish that meets or exceeds indoor air quality standards. This proprietary finish is virtually VOC-free, has remarkable durability and allows the beauty of wood to show through
- Surfaces feature a semi-open pore matte finish

METAL COLORS

423 Concrete
 462 Cinder
 463 Iron
 497 Polished Aluminum
 501 Platinum Metallic
 503 Satin Nickel Metallic

GLASS OPTION

3 Clear

SURFACE GROMMET OPTION

If no grommet is desired, specify an X (No Grommet)

CUT-G12C Cutout only for G12 1 Touch Pivoting Power Grommet
 CUT-G17C Cutout only for G17 1 Touch Pivoting Power Grommet
 CUT-G23C Cutout only for G23 Power Grommet

- Power grommet is optional for box, cube and cylinder styles

SIDE GROMMET OPTION

If no grommet is desired, specify an X (No Grommet)

CUT-G23C Cutout only for G23 Power Grommet

- Power grommet is optional for box, cube and cylinder styles

DIMENSION KEY

D Depth
 W Width
 H Height
 A Overhang: Approach Side
 KW Kneespace Width
 DI Diameter

MYRIAD OCCASIONAL TABLES

TO ORDER, SPECIFY:

1. Model Number
2. Surface Grommet
3. Side Grommet
4. Paint
5. Finish/Laminate Color

SAMPLE MODEL NUMBER:

91NB2424ENW X X 501 MH
 • See page 500 for all options available in Occasional Tables

MODEL NO./DESCRIPTION	LIST PRICE	DIMENSIONS					CARTONED WEIGHT	CUBIC FEET
		D	W	H	A	KW		
WOOD								
91NB2424ENW End Table	\$ 1569	24	24	20½	—	—	55 lbs.	12.6
91NB1850CSW Console Table	2136	18	50	31½	—	—	75 lbs.	20.2
91NB2448MGW Magazine Table	1678	24	48	16½	—	—	77 lbs.	19.1
91NB3636MGW Coffee Table	1747	36	36	16½	—	—	65 lbs.	15.0
LAMINATE								
91NB2424ENL End Table	\$ 1312	24	24	20½	—	—	55 lbs.	12.6
91NB1850CSL Console Table	1886	18	50	31½	—	—	75 lbs.	20.2
91NB2448MGL Magazine Table	1426	24	48	16½	—	—	77 lbs.	19.1
91NB3636MGL Coffee Table	1490	36	36	16½	—	—	65 lbs.	15.0

MYRIAD BOX

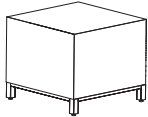

End Table

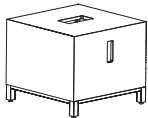

Optional Surface and Side Grommet Locations

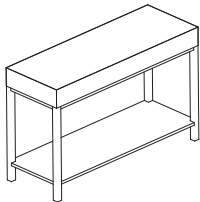

Console Table

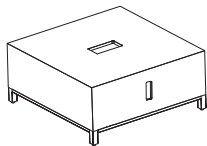
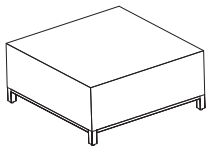
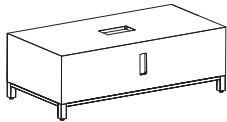
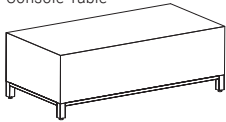

- Optional glass and solid surface kits available; reference page 520
- Features an aluminum base in 3 color options
- Optional surface grommet cutout available in G12, G17, and G23 cutout (+\$25 list)
- Optional side grommet cutout available in G23 cutout (+\$25 list)
- Grommet option not available on console table
- Power grommet sold separately; reference pages 547-549, 554-557, and 560 for pricing and details
- Reference Myriad for detailed product information, finishes and entire Myriad offering starting on page 500

MYRIAD OCCASIONAL TABLES



TO ORDER, SPECIFY:

1. Model Number
2. Surface Grommet
3. Side Grommet (Cubes Only)
4. Finish/Laminate Color

SAMPLE MODEL NUMBERS:

91NA2424CYW X NM
91NA2424CUW X X MH

- See page 500 for all options available in Occasional Tables

MODEL NO./DESCRIPTION	LIST PRICE	DIMENSIONS					CARTONED WEIGHT	CUBIC FEET		
		D	W	H	A	KW				
MYRIAD CYLINDER		WOOD		DI		H				
 End Table	91NA2424CYW	End Table	\$ 1142	24	—	20½	—	—	35 lbs.	11.0
 Coffee Table	91NA3636MGYW	Coffee Table	1538	36½	—	16½	—	—	55 lbs.	18.6
LAMINATE										
	91NA2424CYL	End Table	\$ 705	24	—	20½	—	—	35 lbs.	11.0
	91NA3636MGYL	Coffee Table	1052	36½	—	16½	—	—	55 lbs.	18.6

- Optional glass and solid surface kits available; reference page 520
- Optional surface center grommet cutout available in G12, G17, and G23 cutout (+\$25 list)
- Power grommet sold separately; reference pages 547-549, 554-557, and 560 for pricing and details
- Reference Myriad for detailed product information, finishes and entire Myriad offering starting on page 500

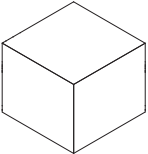
MODEL NO./DESCRIPTION	LIST PRICE	DIMENSIONS					CARTONED WEIGHT	CUBIC FEET					
		D	W	H	A	KW							
MYRIAD CUBE		WOOD		D		W		H		A		KW	
 End Table	91NA2424CUW	End Table	\$ 1142	24	24	20½	—	—	—	—	—	33 lbs.	11.1
	91NA2448MGTW	Magazine Table	1442	24	48	16½	—	—	—	—	—	66 lbs.	17.2
	91NA3636MGUW	Coffee Table	1442	36	36	16½	—	—	—	—	—	55 lbs.	18.9
LAMINATE													
	91NA2424CUL	End Table	\$ 705	24	24	20½	—	—	—	—	—	33 lbs.	11.1
	91NA2448MGTL	Magazine Table	972	24	48	16½	—	—	—	—	—	66 lbs.	17.2
	91NA3636MGUL	Coffee Table	972	36	36	16½	—	—	—	—	—	55 lbs.	18.9

- Optional glass and solid surface kits available; reference page 520
- Optional surface grommet cutout available in G12, G17, and G23 cutout (+\$25 list)
- Optional side grommet cutout available in G23 cutout (+\$25 list)
- Power grommet sold separately; reference pages 547-549, 554-557, and 560 for pricing and details
- Reference Myriad for detailed product information, finishes and entire Myriad offering starting on page 500

Optional Surface and Side Grommet Locations

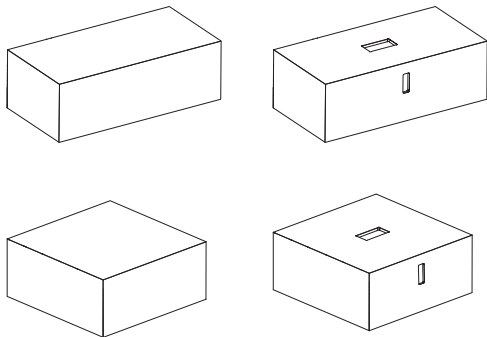

MYRIAD OCCASIONAL TABLES

TO ORDER, SPECIFY:

1. Model Number
2. Glass
3. Metal Color

SAMPLE MODEL NUMBER:

91NC2424ENG 3 462
 • See page 500 for all options available in Occasional Tables

MODEL NO./DESCRIPTION	LIST PRICE	DIMENSIONS					CARTONED WEIGHT	CUBIC FEET
		D	W	H	A	KW		
MYRIAD FLOATING TOP								
GLASS TOPS								
91NC2424ENG End Table	\$ 1866	24	24	20½	—	—	30 lbs.	2.2
91NC1850CSG Console Table	2415	18	50	28½	—	—	53 lbs.	5.2
91NC2448MGG Magazine Table	2169	24	48	16½	—	—	57 lbs.	5.5
91NC3636MGG Coffee Table	2169	36	36	16½	—	—	50 lbs.	3.5

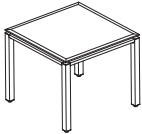

End Table

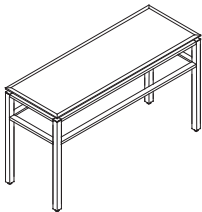

Console Table

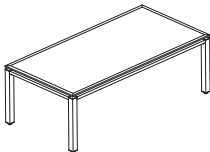

Magazine Table

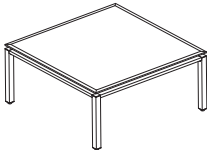

Coffee Table

- Some assembly required – glass must be attached to base
- Glass is clear with beveled rim
- Features an aluminum base
- Glass is ¾" thick
- Reference Myriad for detailed product information, finishes and entire Myriad offering starting on page 500

OCCASIONAL TABLES

MYRIAD OCCASIONAL TABLES

TO ORDER, SPECIFY:

1. Model Number
2. Finish/Laminate Color
3. Metal Color

SAMPLE MODEL NUMBER:

91NC2424ENW MH 501

• See page 500 for all options available in Occasional Tables

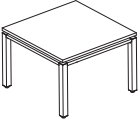
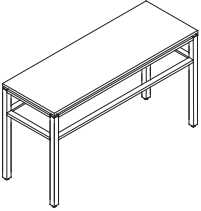
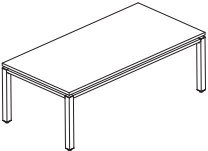
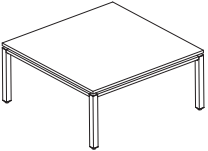
	MODEL NO./DESCRIPTION	LIST PRICE	DIMENSIONS					CARTONED WEIGHT	CUBIC FEET	
			D	W	H	A	KW			
MYRIAD FLOATING TOP										
VENEER TOPS										
 End Table	91NC2424ENW	\$ 1539	24	24	20½	–	–	30 lbs.	2.2	
	91NC1850CSW	1947	18	50	28½	–	–	53 lbs.	5.2	
	91NC2448MGW	1747	24	48	16½	–	–	57 lbs.	5.5	
	91NC3636MGW	1747	36	36	16½	–	–	50 lbs.	3.5	
LAMINATE TOPS										
 Console Table	91NC2424ENL	\$ 1280	24	24	20½	–	–	30 lbs.	2.2	
	91NC1850CSL	1695	18	50	28½	–	–	53 lbs.	5.2	
	91NC2448MGL	1490	24	48	16½	–	–	57 lbs.	5.5	
	91NC3636MGL	1490	36	36	16½	–	–	50 lbs.	3.5	
<ul style="list-style-type: none"> • Floating top style with laminate tops are available in a CSL; reference page 18 for program details • Features an aluminum base in 4 color options • Grommet not available on floating top styles • Floating top is ¾" thick • Veneer tables feature matte/satin sheen • Reference Myriad for detailed product information, finishes and entire Myriad offering starting on page 500 										
 Magazine Table										
	 Coffee Table									

TO ORDER, SPECIFY:

1. Model Number
2. Surface Grommet
3. Side Grommet (Square Only)
4. Paint
5. Finish/Laminate Color

SAMPLE MODEL NUMBER:

N32T24ENW X 462 MH

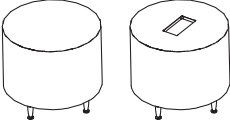
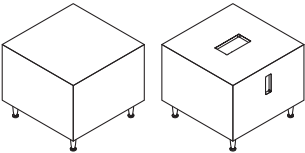
	MODEL NO./DESCRIPTION	LIST PRICE	DIMENSIONS					CARTONED CUBIC		
			D	W	H	A	KW	WEIGHT	FEET	
RENO END TABLE										
 <p>Optional Surface Grommet Location</p>	ROUND		DI	H						
	N32T24ENW	Wood	\$ 1518	24	—	20 ¹ / ₁₆	—	—	35 lbs.	11.0
	N32T24ENL	Laminate	1278	24	—	20 ¹ / ₁₆	—	—	35 lbs.	11.0
<ul style="list-style-type: none"> • Side grommet not available on round models • Optional surface grommet cutout available in G12, G17, and G23 cutout (+\$25 list) 										
 <p>Optional Surface and Side Grommet Locations</p>	SQUARE		D	W	H	A	KW			
	N32T2424ENW	Wood	\$ 1518	24	24	20 ¹ / ₁₆	—	—	55 lbs.	12.6
	N32T2424ENL	Laminate	1278	24	24	20 ¹ / ₁₆	—	—	55 lbs.	12.6
<ul style="list-style-type: none"> • Optional surface grommet cutout available in G12, G17, and G23 cutout (+\$25 list) • Optional side grommet cutout on square table available in G23 cutout (+\$25 list) • Some assembly required; feet are field installed • Power grommet sold separately; reference pages 547-549, 554-557, and 560 for pricing and details • Optional glass and solid surface kits available; reference page 520 • Reference Reno for detailed product information, finishes and entire Reno offering starting on page 362 in the Seating Price List 										

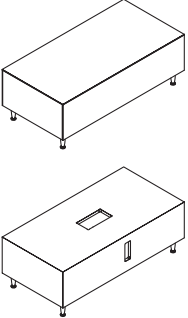
RENO MAGAZINE TABLE									
 <p>Optional Surface and Side Grommet Locations</p>	N32T2448MGW	Wood	\$ 1628	24	48	16 ¹ / ₁₆	—	77	19.1 lbs.
		N32T2448MGL	Laminate	1394	24	48	16 ¹ / ₁₆	—	77
<ul style="list-style-type: none"> • Optional surface grommet cutout available in G12, G17, and G23 cutout (+\$25 list) • Optional side grommet cutout available in G23 cutout (+\$25 list) • Some assembly required; feet are field installed • Power grommet sold separately; reference pages 547-549, 554-557, and 560 for pricing and details • Optional glass and solid surface kits available; reference page 520 • Reference Reno for detailed product information, finishes and entire Reno offering starting on page 362 in the Seating Price List 									

RENO OCCASIONAL TABLES

TO ORDER, SPECIFY:

1. Model Number
2. Surface Grommet
3. Side Grommet (Square Only)
4. Paint
5. Finish/Laminate Color

SAMPLE MODEL NUMBER:

N32T36MGW X 462 MH

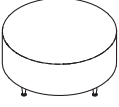
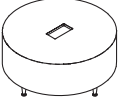
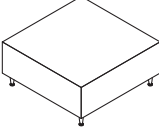
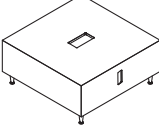
RENO COFFEE TABLE	MODEL NO./DESCRIPTION	LIST PRICE	DIMENSIONS					CARTONED WEIGHT	CUBIC FEET
			D	W	H	A	KW		
  Optional Surface Grommet Location	ROUND		DI		H				
	N32T36MGW Wood	\$ 1693	36 ¹ / ₁₆	—	16 ¹ / ₁₆	—	—	55 lbs.	18.6
	N32T36MGL Laminate	1461	36 ¹ / ₁₆	—	16 ¹ / ₁₆	—	—	55 lbs.	18.6
  Optional Surface and Side Grommet Locations	SQUARE		D	W	H	A	KW		
	N32T3636MGW Wood	\$ 1693	36	36	16 ¹ / ₁₆	—	—	65 lbs.	15.0
	N32T3636MGL Laminate	1461	36	36	16 ¹ / ₁₆	—	—	65 lbs.	15.0

- Side grommet not available on round models
- Optional surface grommet cutout available in G12, G17, and G23 cutout (+\$25 list)

- Optional surface grommet cutout available in G12, G17, and G23 cutout (+\$25 list)
- Optional side grommet cutout available in G23 cutout (+\$25 list)

- Some assembly required; feet are field installed
- Power grommet sold separately; reference pages 547-549, 554-557, and 560 for pricing and details
- Optional glass and solid surface kits available; reference page 520
- Reference Reno for detailed product information, finishes and entire Reno offering starting on page 362 in the Seating Price List

ROOSEVELT OCCASIONAL TABLES



Shaded model numbers are available on our "To You in 10 Days or Less" Quick Delivery program and will be delivered in 10 days or less.

TO ORDER, SPECIFY:

1. Model Number
2. Finish/Laminate Color

SAMPLE MODEL NUMBER:

51N2040MGW MH

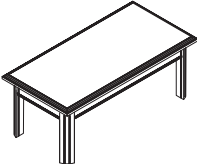
	MODEL NO./DESCRIPTION	LIST PRICE	DIMENSIONS					CARTONED CUBIC	
			D	W	H	A	KW	WEIGHT	FEET
ROOSEVELT MAGAZINE TABLE 	51N2040MGW Wood Top	\$ 1093	19 ³ / ₄	39 ³ / ₄	18 ³ / ₁₆	—	—	42 lbs.	3.0
	Q51N2040MGLW Laminate Top	940	19 ³ / ₄	39 ³ / ₄	18 ³ / ₁₆	—	—	42 lbs.	3.0
	51N2040MGLW Laminate Top	940	19 ³ / ₄	39 ³ / ₄	18 ³ / ₁₆	—	—	42 lbs.	3.0

- Some assembly required
- Laminate top tables have veneer legs/base
- Reference Roosevelt for detailed product information, finishes and entire Roosevelt offering starting on page 160 in the Casegoods Book 1 Price List

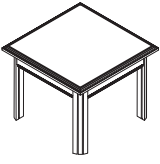
	MODEL NO./DESCRIPTION	LIST PRICE	DIMENSIONS					CARTONED CUBIC	
			D	W	H	A	KW	WEIGHT	FEET
ROOSEVELT END TABLE 	51N2424ENW Wood Top	\$ 940	23 ³ / ₄	23 ³ / ₄	22 ³ / ₁₆	—	—	38 lbs.	2.8
	Q51N2424ENLW Laminate Top	836	23 ³ / ₄	23 ³ / ₄	22 ³ / ₁₆	—	—	38 lbs.	2.8
	51N2424ENLW Laminate Top	836	23 ³ / ₄	23 ³ / ₄	22 ³ / ₁₆	—	—	38 lbs.	2.8

- Some assembly required
- Laminate top tables have veneer legs/base
- Reference Roosevelt for detailed product information, finishes and entire Roosevelt offering starting on page 160 in the Casegoods Book 1 Price List

STACCATO OCCASIONAL TABLES

ROUND TABLE SIZES

End Table 24" Diameter
 Coffee Table 36" Diameter
 Counter Height 24" and 36" Diameter
 Bar Height 24" and 36" Diameter

SOFT SQUARE TABLE SIZES

End Table 24" x 24"
 Coffee Table 36" x 36"
 Counter Height 24" x 24" and 36" x 36"
 Bar Height 24" x 24" and 36" x 36"

GLASS TOP KITS AVAILABLE FOR

Round
 Soft Square

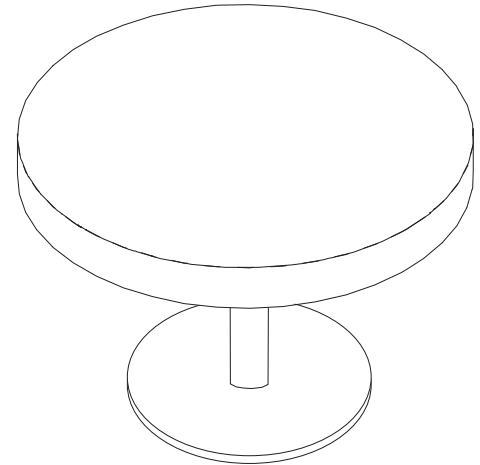

WOOD FINISHES

AC Autumn
 CL Caramel
 CW Cordovan
 DW Judicial
 HN Honey
 IM Brighton
 MC Amber
 MH Mocha
 NM Natural
 TF Truffle

- Veneer tables are plain sliced slipmatched cherry (Amber, Autumn, Mocha, Truffle), maple veneer (Brighton, Caramel, Honey, Natural), or plain sliced bookmatched walnut veneer (Cordovan, Judicial)

LAMINATES

WOODGRAIN LAMINATE

AC2 Autumn 2
 AD Almond
 CL Caramel
 CW Cordovan
 DW Judicial
 HN2 Honey 2
 IM Brighton
 MC Amber
 MH Mocha
 NM Natural
 PB Portobello
 PT Portico
 SK Skyline
 SM Sonoma
 TF Truffle
 792 Sable
 793 Acorn

SOLID LAMINATE

405 Designer White
 419 Wallaby
 425 Shadow
 440 Cloud
 461 Graphite
 462 Cinder
 478 Platinum Grey
 488 Frosty White
 491 Designer White Linear
 492 Cinder Linear

PATTERN LAMINATE

814 White Tigris
 818 Crisp Linen
 819 Flax Gauze
 821 Elemental Concrete
 822 Smoke Quarstone
 874 Bronze Legacy

FINISH APPLICATION

- Finish is a water-based, high performance wood finish that meets or exceeds indoor air quality standards. This proprietary finish is virtually VOC-free, has remarkable durability and allows the beauty of wood to show through
- Surfaces feature a semi-open pore matte finish

COLUMN PAINT COLOR

405 Designer White
 423 Concrete
 462 Cinder
 463 Iron
 501 Platinum Metallic
 503 Satin Nickel Metallic

FOOT PAINT COLOR

405 Designer White
 423 Concrete
 462 Cinder
 463 Iron
 501 Platinum Metallic
 503 Satin Nickel Metallic

OCCASIONAL TABLES

DIMENSION KEY

D Depth
 W Width
 H Height
 A Overhang: Approach Side
 KW Kneespace Width
 DI Diameter

STACCATO OCCASIONAL TABLES

TO ORDER, SPECIFY:

1. Model Number
2. Finish/Laminate Color
3. Column Paint Color
4. Foot Paint Color

SAMPLE MODEL NUMBER:

82N3636MGRDW MH 462 405

- See page 508 for all options available in Occasional Tables

MODEL NO./DESCRIPTION	LIST PRICE	DIMENSIONS					CARTONED WEIGHT	CUBIC FEET
		D	W	H	A	KW		
STACCATO COFFEE TABLE		ROUND		DI	H			
82N3636MGRDW	Wood	\$ 2169	36 ¹ / ₁₆	—	17 ¹ / ₁₆	—	—	97 lbs. 9.6
82N3636MGRDL	Laminate	1892	36 ¹ / ₁₆	—	17 ¹ / ₁₆	—	—	97 lbs. 9.6
		SOFT SQUARE		D	W	H	A	KW
82N3636MGSQW	Wood	\$ 2296	36	36	17 ¹ / ₁₆	—	—	97 lbs. 9.6
82N3636MGSQL	Laminate	2019	36	36	17 ¹ / ₁₆	—	—	97 lbs. 9.6

- Some assembly required
- No grommet cutouts available
- Optional glass and solid surface kits available; reference page 520
- 3" column base
- Glide adjustment of +/- 1/8"
- 4 1/8" height top
- Column available in paint colors (405) Designer White, (423) Concrete, (462) Cinder, (463) Iron, (501) Platinum Metallic, or (503) Satin Nickel Metallic
- Foot available in paint colors (405) Designer White, (423) Concrete, (462) Cinder, (463) Iron, (501) Platinum Metallic, or (503) Satin Nickel Metallic
- Reference Staccato for detailed product information, finishes and entire Staccato offering starting on page 508

MODEL NO./DESCRIPTION	LIST PRICE	DIMENSIONS					CARTONED WEIGHT	CUBIC FEET
		D	W	H	A	KW		
STACCATO END TABLE		ROUND		DI	H			
82N2424MGRDW	Wood	\$ 1866	23 ³ / ₁₆	—	20 ¹ / ₁₆	—	—	64 lbs. 7.3
82N2424MGRDL	Laminate	1588	23 ³ / ₁₆	—	20 ¹ / ₁₆	—	—	64 lbs. 7.3
		SOFT SQUARE		D	W	H	A	KW
82N2424MGSQW	Wood	\$ 1994	24	24	20 ¹ / ₁₆	—	—	64 lbs. 7.3
82N2424MGSQL	Laminate	1714	24	24	20 ¹ / ₁₆	—	—	64 lbs. 7.3

- Some assembly required
- No grommet cutouts available
- Optional glass and solid surface kits available; reference page 520
- 3" column base
- Glide adjustment of +/- 1/8"
- 4 1/8" height top
- Column available in paint colors (405) Designer White, (423) Concrete, (462) Cinder, (463) Iron, (501) Platinum Metallic, or (503) Satin Nickel Metallic
- Foot available in paint colors (405) Designer White, (423) Concrete, (462) Cinder, (463) Iron, (501) Platinum Metallic, or (503) Satin Nickel Metallic
- Reference Staccato for detailed product information, finishes and entire Staccato offering starting on page 508

STACCATO OCCASIONAL TABLES

TO ORDER, SPECIFY:

1. Model Number
2. Finish/Laminate Color
3. Column Paint Color
4. Foot Paint Color

SAMPLE MODEL NUMBER:

82N363635RDTW MH 462 405

- See page 508 for all options available in Occasional Tables

MODEL NO./DESCRIPTION	LIST PRICE	DIMENSIONS					CARTONED WEIGHT	CUBIC FEET
		D	W	H	A	KW		
STACCATO COUNTER HEIGHT TABLE		ROUND		DI	H			
82N363635RDTW Wood	\$ 2284	36 ¹ / ₁₆	—	35 ⁷ / ₁₆	—	—	112 lbs.	11.1
82N363635RDTL Laminate	2006	36 ¹ / ₁₆	—	35 ⁷ / ₁₆	—	—	112 lbs.	11.1
82N242435RDTW Wood	\$ 2139	23 ³ / ₈	—	35 ⁷ / ₁₆	—	—	80 lbs.	8.8
82N242435RDTL Laminate	1862	23 ³ / ₈	—	35 ⁷ / ₁₆	—	—	80 lbs.	8.8
SOFT SQUARE		D	W	H	A	KW		
82N363635SQTW Wood	\$ 2412	36	36	35 ⁷ / ₁₆	—	—	112 lbs.	11.1
82N363635SQTL Laminate	2134	36	36	35 ⁷ / ₁₆	—	—	112 lbs.	11.1
82N242435SQTW Wood	\$ 2267	24	24	35 ⁷ / ₁₆	—	—	80 lbs.	8.8
82N242435SQTL Laminate	1988	24	24	35 ⁷ / ₁₆	—	—	80 lbs.	8.8

- Some assembly required
- No grommet cutouts available
- Optional glass and solid surface kits available; reference page 520
- 3" column base
- Glide adjustment of +/- 1/8"
- 4 1/8" height top
- Column available in paint colors (405) Designer White, (423) Concrete, (462) Cinder, (463) Iron, (501) Platinum Metallic, or (503) Satin Nickel Metallic
- Foot available in paint colors (405) Designer White, (423) Concrete, (462) Cinder, (463) Iron, (501) Platinum Metallic, or (503) Satin Nickel Metallic
- Reference Staccato for detailed product information, finishes and entire Staccato offering starting on page 508

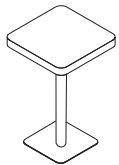
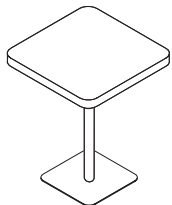
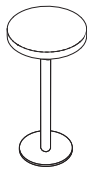
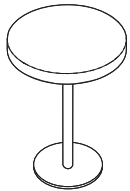

STACCATO OCCASIONAL TABLES

TO ORDER, SPECIFY:

1. Model Number
2. Finish/Laminate Color
3. Column Paint Color
4. Foot Paint Color

SAMPLE MODEL NUMBER:

82N363640RDTW MH 462 405

- See page 508 for all options available in Occasional Tables

MODEL NO./DESCRIPTION	LIST PRICE	DIMENSIONS					CARTONED WEIGHT	CUBIC FEET	
		D	W	H	A	KW			
ROUND		DI	H						
82N363640RDTW Wood	\$ 2346	36 ¹ / ₁₆	—	41 ¹ / ₁₆	—	—	112 lbs.	11.5	
82N363640RDTL Laminate	2070	36 ¹ / ₁₆	—	41 ¹ / ₁₆	—	—	112 lbs.	11.5	
<hr/>									
82N242440RDTW Wood	\$ 2200	23 ³ / ₈	—	41 ¹ / ₁₆	—	—	80 lbs.	9.2	
82N242440RDTL Laminate	1922	23 ³ / ₈	—	41 ¹ / ₁₆	—	—	80 lbs.	9.2	
<hr/>									
SOFT SQUARE		D	W	H	A	KW			
82N363640SQTW Wood	\$ 2472	36	36	41 ¹ / ₁₆	—	—	112 lbs.	11.5	
82N363640SQTL Laminate	2194	36	36	41 ¹ / ₁₆	—	—	112 lbs.	11.5	
<hr/>									
82N242440SQTW Wood	\$ 2329	24	24	41 ¹ / ₁₆	—	—	80 lbs.	9.2	
82N242440SQTL Laminate	2051	24	24	41 ¹ / ₁₆	—	—	80 lbs.	9.2	

STACCATO BAR HEIGHT TABLE

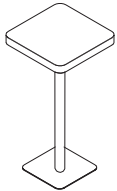
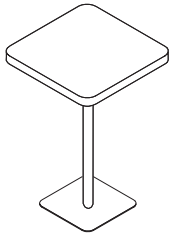
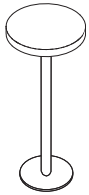
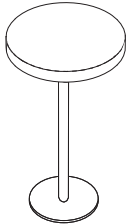

- Some assembly required
- No grommet cutouts available
- Optional glass and solid surface kits available; reference page 520
- 3" column base
- Glide adjustment of +/- 1/8"
- 4 1/8" height top
- Column available in paint colors (405) Designer White, (423) Concrete, (462) Cinder, (463) Iron, (501) Platinum Metallic, or (503) Satin Nickel Metallic
- Foot available in paint colors (405) Designer White, (423) Concrete, (462) Cinder, (463) Iron, (501) Platinum Metallic, or (503) Satin Nickel Metallic
- Reference Staccato for detailed product information, finishes and entire Staccato offering starting on page 508

SWIFT OCCASIONAL TABLES

TO ORDER, SPECIFY:

1. Model Number
2. Surface Grommet
3. Side Grommet
4. Finish/Laminate Color
5. Frame Color

SAMPLE MODEL NUMBERS:

N95PPW X X CL 497
 N95PPL X X MC 501

	MODEL NO./DESCRIPTION	LIST PRICE	DIMENSIONS					CARTONED CUBIC	
			D	W	H	A	KW	WEIGHT	FEET
SWIFT SMALL END TABLE	N95PPW Wood	\$ 1389	28	14	16½	—	—	31.8 lbs.	7.5
	N95PPL Laminate	1289	28	14	16½	—	—	31.8 lbs.	7.5

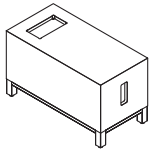
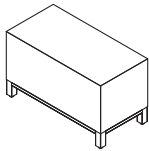

Optional Surface and Side Grommet Locations

- Power grommet sold separately; reference pages 547-549, 554-557, and 560 for pricing and details
- Optional surface grommet cutout available in G12, G17, and G23 cutout (+\$25 list)
- Optional side grommet cutout available in G23 cutout (+\$25 list)
- Reference Swift for detailed product information, finishes and entire Swift offering starting on page 462 in the Seating Price List

SWIFT COFFEE TABLE	N95RRW Wood	\$ 2169	36	36	13¾	—	—	70 lbs.	16.8
	N95RRL Laminate	2070	36	36	13¾	—	—	70 lbs.	16.8

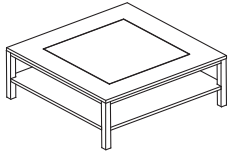

- Power grommet option not available
- Frosted ⅜" thick tempered glass insert
- Reference Swift for detailed product information, finishes and entire Swift offering starting on page 462 in the Seating Price List

SWIFT CONSOLE TABLE	N95SSW Wood	\$ 2318	18	50	33½	—	—	74.2 lbs.	26.4
	N95SSL Laminate	2217	18	50	33½	—	—	74.2 lbs.	26.4

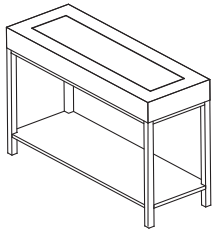

- Power grommet option not available
- Frosted ⅜" thick tempered glass insert
- Reference Swift for detailed product information, finishes and entire Swift offering starting on page 462 in the Seating Price List

SWIFT OCCASIONAL TABLES

TO ORDER, SPECIFY:

1. Model Number
2. Surface Grommet
3. Side Grommet
4. Finish/Laminate Color
5. Frame Color

SAMPLE MODEL NUMBERS:

N95KKW X X CW 462
 N95KKL X X 462 501

	MODEL NO./DESCRIPTION	LIST PRICE	DIMENSIONS						CARTONED CUBIC	
			D	W	H	A	KW	WEIGHT	FEET	
SWIFT 30° TABLE	N95KKW Wood	\$ 1661	30¾	25	16½	—	—	40 lbs.	12.6	
	N95KKL Laminate	1559	30¾	25	16½	—	—	40 lbs.	12.6	

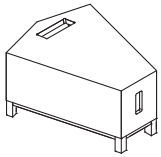
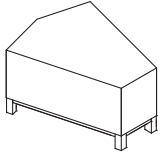

Optional Surface and Side Grommet Locations

- Power grommet sold separately; reference pages 547-549, 554-557, and 560 for pricing and details
- Optional surface grommet cutout available in G12, G17, and G23 cutout (+\$25 list)
- Optional side grommet cutout available in G23 cutout (+\$25 list)
- Reference Swift for detailed product information, finishes and entire Swift offering starting on page 462 in the Seating Price List

SWIFT 45° TABLE	N95LLW Wood	\$ 1797	32¾	31½	16½	—	—	45.2 lbs.	16.3
	N95LLL Laminate	1695	32¾	31½	16½	—	—	45.2 lbs.	16.3

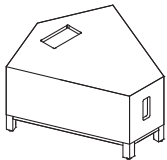
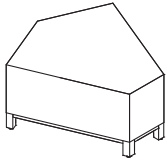

Optional Surface and Side Grommet Locations

- Power grommet sold separately; reference pages 547-549, 554-557, and 560 for pricing and details
- Optional surface grommet cutout available in G12, G17, and G23 cutout (+\$25 list)
- Optional side grommet cutout available in G23 cutout (+\$25 list)
- Reference Swift for detailed product information, finishes and entire Swift offering starting on page 462 in the Seating Price List

SWIFT 90° TABLE	N95NNW Wood	\$ 1865	28	28	16½	—	—	47.8 lbs.	13.1
	N95NNL Laminate	1764	28	28	16½	—	—	47.8 lbs.	13.1

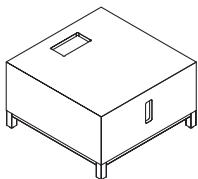
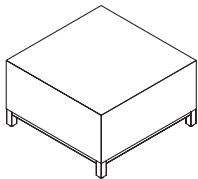

Optional Surface and Side Grommet Locations

- Power grommet sold separately; reference pages 547-549, 554-557, and 560 for pricing and details
- Optional surface grommet cutout available in G12, G17, and G23 cutout (+\$25 list)
- Optional side grommet cutout available in G23 cutout (+\$25 list)
- Reference Swift for detailed product information, finishes and entire Swift offering starting on page 462 in the Seating Price List

TAG OCCASIONAL TABLES

TO ORDER, SPECIFY:

1. Model Number
2. Finish/Laminate Color
3. Frame Color

SAMPLE MODEL NUMBER:

N60SGW MC 462

	MODEL NO./DESCRIPTION	LIST PRICE	DIMENSIONS					CARTONED WEIGHT	CUBIC FEET
			D	W	H	A	KW		
TAG END TABLE	N60SGW Wood Top	\$ 620	18	20	17 $\frac{3}{4}$	—	—	15 lbs.	6.1
	N60SGL Laminate Top	522	18	20	17 $\frac{3}{4}$	—	—	15 lbs.	6.1

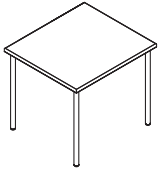

- Platinum Metallic option available for a \$40 list upcharge
- Reference Tag for detailed product information, finishes and entire Tag offering starting on page 488 in the Seating Price List

TAG CORNER TABLE	N60SHW Wood Top	\$ 874	28	28	17 $\frac{3}{4}$	—	—	24 lbs.	11.5
	N60SHL Laminate Top	777	28	28	17 $\frac{3}{4}$	—	—	24 lbs.	11.5



- Platinum Metallic option available for a \$40 list upcharge
- Reference Tag for detailed product information, finishes and entire Tag offering starting on page 488 in the Seating Price List

TAG MAGAZINE TABLE	N60SKW Wood Top	\$ 848	19 $\frac{1}{2}$	39 $\frac{1}{2}$	16	—	—	24 lbs.	10.7
	N60SKL Laminate Top	750	19 $\frac{1}{2}$	39 $\frac{1}{2}$	16	—	—	24 lbs.	10.7

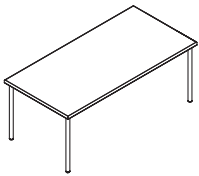

- Platinum Metallic option available for a \$40 list upcharge
- Reference Tag for detailed product information, finishes and entire Tag offering starting on page 488 in the Seating Price List

TESSERA OCCASIONAL TABLES

TO ORDER, SPECIFY:

1. Model Number
2. Leg Color
3. Finish/Laminate Color

SAMPLE MODEL NUMBERS:

- | | | |
|-------------|-----|----|
| 59N24ENRDW | 501 | MH |
| 59N24ENRDLW | 501 | MH |

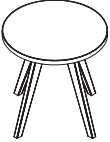
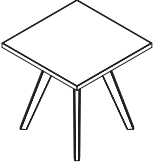
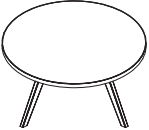
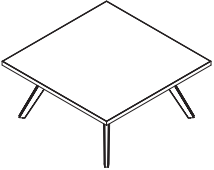
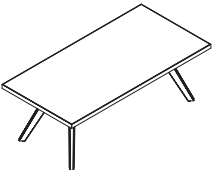
	MODEL NO./DESCRIPTION	LIST PRICE	DIMENSIONS					CARTONED WEIGHT	CUBIC FEET	
			D	W	H	A	KW			
TESSERA END TABLE  	ROUND									
	59N24ENRDW	Wood	\$ 1742	24	24	23 $\frac{3}{4}$	—	—	83 lbs.	14.2
	59N24ENRDLW	Laminate	1483	24	24	23 $\frac{3}{4}$	—	—	83 lbs.	14.2
	SQUARE									
	59N2424ENSQW	Wood	\$ 1861	24	24	23 $\frac{3}{4}$	—	—	55 lbs.	14.2
	59N2424ENSQW	Laminate	1601	24	24	23 $\frac{3}{4}$	—	—	55 lbs.	14.2
	<ul style="list-style-type: none"> • No grommet cutouts available • 1$\frac{1}{8}$" thick top • Reference Tessera for detailed product information, finishes and entire Tessera offering starting on page 172 in the Casegoods Book 1 Price List 									
TESSERA COFFEE TABLE  	ROUND									
	59N36MGRDW	Wood	\$ 2026	36 $\frac{1}{2}$	36 $\frac{1}{2}$	16 $\frac{3}{4}$	—	—	55 lbs.	21.6
	59N36MGRDLW	Laminate	1766	36 $\frac{1}{2}$	36 $\frac{1}{2}$	16 $\frac{3}{4}$	—	—	55 lbs.	21.6
	SQUARE									
	59N3636MGSQW	Wood	\$ 2143	36 $\frac{1}{2}$	36 $\frac{1}{2}$	16 $\frac{3}{4}$	—	—	65 lbs.	21.6
	59N3636MGSQW	Laminate	1884	36 $\frac{1}{2}$	36 $\frac{1}{2}$	16 $\frac{3}{4}$	—	—	65 lbs.	21.6
	<ul style="list-style-type: none"> • No grommet cutouts available • 1$\frac{1}{8}$" thick top • Reference Tessera for detailed product information, finishes and entire Tessera offering starting on page 172 in the Casegoods Book 1 Price List 									
TESSERA MAGAZINE TABLE 	59N2448MGW	Wood	\$ 2026	24	48	16 $\frac{3}{4}$	—	—	77 lbs.	19.7
	59N2448MGLW	Laminate	1766	24	48	16 $\frac{3}{4}$	—	—	77 lbs.	19.7
	<ul style="list-style-type: none"> • No grommet cutouts available • 1$\frac{1}{8}$" thick top • Reference Tessera for detailed product information, finishes and entire Tessera offering starting on page 172 in the Casegoods Book 1 Price List 									
	<ul style="list-style-type: none"> • Reference Tessera for detailed product information, finishes and entire Tessera offering starting on page 172 in the Casegoods Book 1 Price List 									

UNIVERSAL OCCASIONAL TABLES

SOLID SURFACE TOP OPTIONS

COLORS

- 7101 Bisque (Grade A)
- 7201 Glacier White (Grade A)
- 7202 Canyon (Grade B)
- 7203 Designer White (Grade B)
- 7204 Silt (Grade B)
- 7301 Concrete (Grade C)
- 7302 Deep Night Sky (Grade C)
- 7303 Deep Nocturne (Grade C)

RIM PROFILE

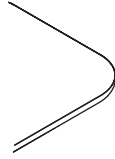

COLUMN PAINT COLOR

- 265 Polished
- 405 Designer White
- 423 Concrete
- 462 Cinder
- 463 Iron
- 501 Platinum Metallic
- 503 Satin Nickel Metallic

BASE PAINT COLOR

- 405 Designer White
- 423 Concrete
- 462 Cinder
- 463 Iron
- 501 Platinum Metallic
- 503 Satin Nickel Metallic

WOOD FINISH

- AC Autumn
- AD Almond
- CL Caramel
- CW Cordovan
- DW Judicial
- HN Honey
- IM Brighton
- MC Amber
- MH Mocha
- NM Natural
- PB Portobello
- PT Portico
- SK Skyline
- SM Sonoma
- TF Truffle
- 405 Designer White
- 462 Cinder
- 792 Sable
- 793 Acorn

WOODGRAIN LAMINATE

- AC2 Autumn 2
- AD Almond
- CL Caramel
- CW Cordovan
- DW Judicial
- HN2 Honey 2
- IM Brighton
- MC Amber
- MH Mocha
- NM Natural
- PB Portobello
- PT Portico
- SK Skyline
- SM Sonoma
- TF Truffle
- 792 Sable
- 793 Acorn*

*Acorn is the laminate complement to Clear Walnut finish

Acorn is the wood complement to Clear Walnut finish

SOLID LAMINATE

- 405 Designer White
- 419 Wallaby
- 425 Shadow
- 440 Cloud
- 461 Graphite
- 462 Cinder
- 478 Platinum Grey
- 488 Frosty White
- 491 Designer White Linear
- 492 Cinder Linear

GALLERY LAMINATE

- Grade 1 – 5% upcharge
- G1001 Citadel
- G1011 Pepperdust
- Grade 2 – 6% upcharge
- G1002 Planked Raw Oak
- G1003 Evening Notte
- G1004 Kirsche
- G1005 Midnight Run
- G1006 Sepia Walnut
- G1007 Serotina
- G1008 Timeless
- G1009 White Nebbia
- G1012 Phantom Ecrú

See page 18 for Gallery program details and upcharges

UNIVERSAL OCCASIONAL TABLES

TO ORDER, SPECIFY:



1. Model Number

SAMPLE MODEL NUMBER:

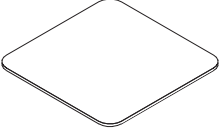
10N3636RDBPG

	MODEL NO./DESCRIPTION	LIST PRICE	DIMENSIONS					CARTONED WEIGHT	CUBIC FEET	
			D	W	H	A	KW			
UNIVERSAL GLASS TOP  	ROUND		DI		H					
	10N3636RDBPG	White Back Painted Glass	\$ 2184	36 $\frac{3}{8}$	—	1 $\frac{1}{2}$	—	—	65 lbs.	4.7
	10N2424RDBPG	White Back Painted Glass	1598	23 $\frac{3}{8}$	—	1 $\frac{1}{2}$	—	—	31 lbs.	1.9
	SOFT SQUARE			D	W	H	A	KW		
	10N3636SQBPG	White Back Painted Glass	\$ 2184	35 $\frac{3}{8}$	35 $\frac{3}{8}$	1 $\frac{1}{2}$	—	—	69 lbs.	4.7
	10N2424SQBPG	White Back Painted Glass	1598	23 $\frac{3}{8}$	23 $\frac{3}{8}$	1 $\frac{1}{2}$	—	—	28 lbs.	1.9

- 24" top for use with 22" disc or soft square base on pages 518-520
- 36" top for use with 27" disc or soft square base on pages 518-520
- 1 $\frac{1}{2}$ " thickness includes the glass and substrate
- Features writable surface
- Footings Bases cannot be used with the Universal glass tops due to the size of the mounting brackets

	ROUND	GRADE A	GRADE B	GRADE C	DI	H						
						D	W	H	A	KW		
UNIVERSAL SOLID SURFACE TOP  	10N36RDS	Solid Surface	\$ 2714	\$ 2966	\$ 3290	36	—	1 $\frac{1}{2}$	—	—	59 lbs.	2.7
	10N24RDS	Solid Surface	1705	1817	1961	24	—	1 $\frac{1}{2}$	—	—	26 lbs.	1.3
	SOFT SQUARE		GRADE A	GRADE B	GRADE C	D	W	H	A	KW		
		10N3636SSQS	Solid Surface	\$ 2714	\$ 2966	\$ 3290	36	36	1 $\frac{1}{2}$	—	—	79 lbs.
	10N2424SSQS	Solid Surface	1705	1817	1961	24	24	1 $\frac{1}{2}$	—	—	38 lbs.	1.3

- Grommet cutout not available on solid surface tops
- Not intended for use with adjustable height bases
- 24" top for use with 22" disc or soft square base on pages 518-520
- 36" top for use with 27" disc or soft square base on pages 518-520

UNIVERSAL OCCASIONAL TABLES



Shaded model numbers are available on our "To You in 10 Days or Less" Quick Delivery program and will be delivered in 10 days or less.

TO ORDER, SPECIFY:

1. Model Number
2. Column Paint Color
3. Base Paint Color

SAMPLE MODEL NUMBER:

CBV2715DRNBP 265 462

	MODEL NO./DESCRIPTION	LIST PRICE	DIMENSIONS				CARTONED CUBIC		
			D	W	H	A	KW	WEIGHT	FEET
DISC BASE OCCASIONAL TABLE HEIGHT	CBV2715DRNBP	\$ 773	3	27 ³ / ₁₆	16	—	—	60 lbs.	1.9
	CBV2215DRNBP	584	3	22	16	—	—	43 lbs.	1.9

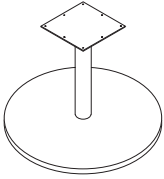

- 3" column base
- Some assembly required
- Reference Base Requirements Chart on pages 643-644 in the Casegoods Book 2 Price List
- Glide adjustment of +/- 1/8"

SOFT SQUARE BASE OCCASIONAL TABLE HEIGHT	CBV2715DSQBP	\$ 900	3	27 ³ / ₁₆	16	—	—	60 lbs.	1.9
	CBV2215DSQBP	709	3	22	16	—	—	50 lbs.	1.9

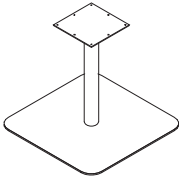

- 3" column base
- Some assembly required
- Reference Base Requirements Chart on pages 643-644 in the Casegoods Book 2 Price List
- Glide adjustment of +/- 1/8"

DISC BASE WORKSURFACE HEIGHT	CBV2728DRNBP	\$ 823	3	27 ³ / ₁₆	27 ³ / ₁₆	—	—	73 lbs.	2.8
	CBV2228DRNBP	616	3	22	27 ³ / ₁₆	—	—	56 lbs.	2.8

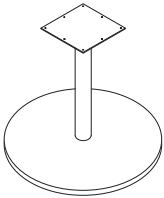

- 3" column base
- Some assembly required
- Reference Base Requirements Chart on pages 643-644 in the Casegoods Book 2 Price List
- Glide adjustment of +/- 1/8"

SOFT SQUARE BASE WORKSURFACE HEIGHT	CBV2728DSQBP	\$ 951	3	27 ³ / ₁₆	27 ³ / ₁₆	—	—	84 lbs.	2.8
	QCBV2228DSQBP	742	3	22	27 ³ / ₁₆	—	—	63 lbs.	2.8
	CBV2228DSQBP	742	3	22	27 ³ / ₁₆	—	—	63 lbs.	2.8

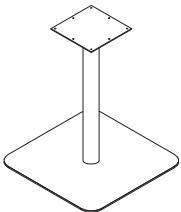

- 3" column base
- Some assembly required
- Reference Base Requirements Chart on pages 643-644 in the Casegoods Book 2 Price List
- Glide adjustment of +/- 1/8"

UNIVERSAL OCCASIONAL TABLES

TO ORDER, SPECIFY:

1. Model Number
2. Column Paint Color
3. Base Paint Color

SAMPLE MODEL NUMBER:

CBV2740DRNBP 265 462

	MODEL NO./DESCRIPTION	LIST PRICE	DIMENSIONS			A	KW	CARTONED WEIGHT	CUBIC FEET
			D	W	H				
DISC BASE COUNTER HEIGHT	CBV2735DRNBP	\$ 889	3	27 ³ / ₁₆	35	—	—	75 lbs.	3.4
	CBV2235DRNBP	857	3	22	35	—	—	58 lbs.	3.4

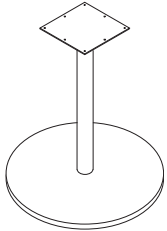

- 3" column base
- Some assembly required
- Reference Base Requirements Chart on pages 643-644 in the Casegoods Book 2 Price List
- Glide adjustment of +/- 1/8"

SOFT SQUARE BASE COUNTER HEIGHT	CBV2735DSQBP	\$ 1016	3	27 ³ / ₁₆	35	—	—	86 lbs.	3.4
	CBV2235DSQBP	983	3	22	35	—	—	65 lbs.	3.4

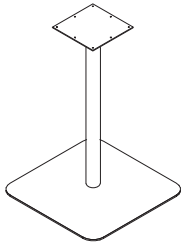

- 3" column base
- Some assembly required
- Reference Base Requirements Chart on pages 643-644 in the Casegoods Book 2 Price List
- Glide adjustment of +/- 1/8"

DISC BASE BAR HEIGHT	CBV2740DRNBP	\$ 951	3	27 ³ / ₁₆	40 ³ / ₄	—	—	76 lbs.	3.8
	CBV2240DRNBP	918	3	22	40 ³ / ₄	—	—	59 lbs.	3.8

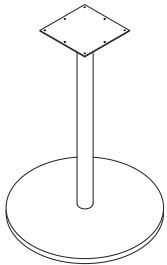

- 3" column base
- Some assembly required
- Reference Base Requirements Chart on pages 643-644 in the Casegoods Book 2 Price List
- Glide adjustment of +/- 1/8"

SOFT SQUARE BASE BAR HEIGHT	CBV2740DSQBP	\$ 1076	3	27 ³ / ₁₆	40 ³ / ₄	—	—	87 lbs.	3.8
	CBV2240DSQBP	1045	3	22	40 ³ / ₄	—	—	66 lbs.	3.8

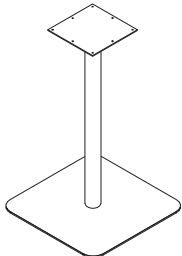

- 3" column base
- Some assembly required
- Reference Base Requirements Chart on pages 643-644 in the Casegoods Book 2 Price List
- Glide adjustment of +/- 1/8"

UNIVERSAL OCCASIONAL TABLES

TO ORDER, SPECIFY:

1. Model Number
2. Solid Surface Grade
3. Solid Surface Color

SAMPLE MODEL NUMBER:

10N2424SQSK A 7101

MODEL NO./DESCRIPTION	LIST PRICE	DIMENSIONS					CARTONED WEIGHT	CUBIC FEET		
		D	W	H	A	KW				
UNIVERSAL SOLID SURFACE KITS										
SQUARE/RECTANGULAR										
	GRADE A	GRADE B	GRADE C							
10N2424SQSK End Table Kit	\$ 1240	\$ 1352	\$ 1496	24	24	¾	—	—	25 lbs.	1.05
10N2448RTSK Magazine Table Kit	1826	2050	2338	24	48	¾	—	—	47 lbs.	2.0
10N3636SQSK Coffee Table Kit	1826	2078	2402	36	36	¾	—	—	52 lbs.	2.2
10N1850RTSK Console Table Kit	1826	2001	2226	18	50	¾	—	—	38 lbs.	1.6
SOFT SQUARE										
10N2424SSQSK End Table Kit	\$ 1221	\$ 1333	\$ 1477	24	24	¾	—	—	25 lbs.	1.1
10N3636SSQSK Coffee Table Kit	1892	2144	2468	36	36	¾	—	—	52 lbs.	2.2
ROUND										
10N2424RDSK End Table Kit	\$ 1221	\$ 1333	\$ 1477	24	—	¾	—	—	23 lbs.	1.1
10N3636RDSK Coffee Table Kit	1892	2144	2468	36	—	¾	—	—	49 lbs.	2.2

- For use on box, cylinder, soft square and cube styles on pages 492, 501-502, and 509-511
- When pairing a solid surface kit with another occasional table, the solid surface top may be sized smaller than the occasional table

UNIVERSAL GLASS KITS

MODEL NO./DESCRIPTION	LIST PRICE	DIMENSIONS					CARTONED WEIGHT	CUBIC FEET
		D	W	H	A	KW		
SQUARE/RECTANGULAR								
10N2424SQGK End Table Kit	\$ 679						55 lbs.	12.6
10N2448RTGK Magazine Table Kit	951	24	48	¾	—	—	77 lbs.	19.1
10N3636SQGK Coffee Table Kit	951	36	36	¾	—	—	75 lbs.	20.2
10N1850RTGK Console Table Kit	951	18	50	¾	—	—	65 lbs.	15.0
SOFT SQUARE								
10N2424SSQGK End Table Kit	\$ 951	24	—	24	—	—	22 lbs.	1.0
10N3636SSQGK Coffee Table Kit	1426	24	—	36	—	—	49 lbs.	2.1
ROUND								
10N2424RDGK End Table Kit	\$ 951	24	—	¾	—	—	18 lbs.	1.0
10N3636RDGK Coffee Table Kit	1426	36	—	¾	—	—	37 lbs.	2.1

- For use on box, cylinder, soft square and cube styles on pages 492, 501-502, and 509-511
- Specify model number only
- Glass is clear with beveled rim
- Glass comes with stanchions for easy attachment to table
- Square kits feature square stanchions and soft square/round kits feature round stanchions

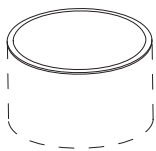
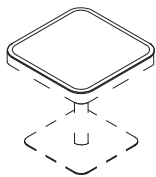
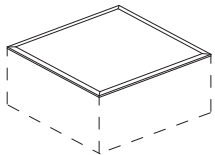
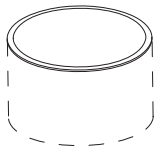
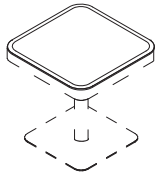
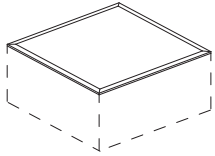

UNIVERSAL OCCASIONAL TABLES

TO ORDER, SPECIFY:

1. Model Number
2. Laminate Color
3. Paint

SAMPLE MODEL NUMBER:

10N1622RTPUW 419 462

	MODEL NO./DESCRIPTION	LIST PRICE	DIMENSIONS				CARTONED CUBIC		
			D	W	H	A	KW	WEIGHT	FEET
PERSONAL PULL-UP TABLE	10N1622RTPUW Wood	\$ 1107	13¾	22	28½	—	—	32 lbs.	9.25
	10N1622RTPUL Laminate	1107	13¾	22	28½	—	—	32 lbs.	9.25



- 50 lb. weight limit
- Specify metal finish (423) Concrete, (462) Cinder, (463) Iron, (501) Platinum Metallic, or (503) Satin Nickel Metallic
- Veneer species is maple
- Acorn is the laminate/wood complement to Clear Walnut finish

PERSONAL PULL-UP TABLE	10N1120RTPU2SS White Marble	\$ 780	11	20	25	—	—	30 lbs.	5.00
	10N1620RTPU2SB Black Marble	780	16	20	25	—	—	30 lbs.	6.95

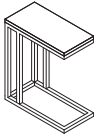

White Marble



Black Marble

- 50 lb. weight limit
- White Marble model has a Platinum Metallic base; Black Marble model has a Cinder base
- 10N1620RTPU2SB top material is Porcelain with pattern Nero Marquina
- 10N1120RTPU2SS top material is Nature Mabel species of Bianco Crown Marble
- Specify model number only

WIXLER OCCASIONAL TABLES

PRODUCT SPECIFICATIONS

TOPS

- Laminate surfaces are 1" HPL (high pressure laminate)
- Veneer surfaces are 1" plain sliced slipmatched cherry (Amber, Autumn, Mocha, Truffle) or maple veneer (Brighton, Caramel, Honey, Natural), plain sliced bookmatched walnut veneer (Clear Walnut, Cordovan, Judicial), quarter cut walnut veneer (Almond, Portobello, Sable), or quarter cut oak veneer (Sonoma)
- When specifying Clear Walnut, a clear coat finish, the natural wood characteristics of walnut veneer are visible. These characteristics include, but are not limited to, color and woodgrain variation
- Solid surface is 1" thick
- Back painted glass surfaces have a 1" thick top including the glass and white substrate
- Veneer and Laminate models also available with standard core with a 3mm PVC rim which is 1" thick
- Grain direction runs left-to-right

RIM PROFILES

- An exposed plywood core for veneer will have color matched on the rim and will be a reversed half-bullnose.
- Clear Walnut will have a clear coat on the rim
- An exposed plywood core for laminate will have a clear coat on the rim and will be a reversed half-bullnose
- Back painted glass has a MDF core with thermofoil edge. It will be a reversed half-bullnose and will be white
- Solid surface does not have a plywood core but will have a reversed half-bullnose and will be the same color as the solid surface
- Veneer and laminate models are available with a 3mm rim option with a standard core. Veneer will have a softened wood rim, while laminate will have a softened PVC rim

UPHOLSTERED TOPS

- 1½" high grade polyurethane foam covers a ½" solid base

LEGS

- All Wixler legs are solid wood

FINISH APPLICATION

- Finish is a water based, high performance wood finish that meets or exceeds indoor air quality standards. This proprietary finish is virtually VOC-free, has remarkable durability, and allows the beauty of the wood to show through
- Surfaces feature a semi-open pore matte finish

TOP/WOOD LEGS FINISHES

AC	Autumn
AD	Almond**
CL	Caramel
CW	Cordovan
DW	Judicial
EW	Clear Walnut**
HN	Honey
IM	Brighton
MC	Amber
MH	Mocha
NM	Natural
PB	Portobello
SM	Sonoma
TF	Truffle
792	Sable

TOP LAMINATE COLORS

WOODGRAIN LAMINATE

AC2	Autumn 2
AD	Almond
CL	Caramel
CW	Cordovan
DW	Judicial
HN2	Honey 2
IM	Brighton
MC	Amber
MH	Mocha
NM	Natural
PB	Portobello
PT	Portico
SK	Skyline
SM	Sonoma
TF	Truffle
792	Sable
793	Acorn*

SOLID LAMINATE

405	Designer White
419	Wallaby
425	Shadow
440	Cloud
461	Graphite
462	Cinder
478	Platinum Grey
488	Frosty White
491	Designer White Linear
492	Cinder Linear

PATTERN LAMINATE

814	White Tigris
818	Crisp Linen
819	Flax Gauze
821	Elemental Concrete
822	Smoke Quarstone
874	Bronze Legacy

GALLERY LAMINATE

Grade 1 – 5% upcharge	
G1001	Citadel
G1011	Pepperdust
Grade 2 – 6% upcharge	
G1002	Planked Raw Oak
G1003	Evening Notte
G1004	Kirsche
G1005	Midnight Run
G1006	Sepia Walnut
G1007	Serotina
G1008	Timeless
G1009	White Nebbia
G1012	Phantom Ecu

*Acorn is the laminate complement to Clear Walnut finish

**Almond is the leg finish complement to Clear Walnut finish

• CSL available; see page 18 for program details and upcharge

See page 18 for Gallery program details and upcharges

RIM PROFILE OPTIONS

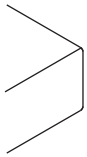

Softened PVC (V)
(laminite tops only)

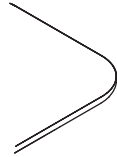

Reversed Half-Bullnose

PVC SOFTENED RIM

AC2	Autumn 2	NM	Natural	440	Cloud
AD	Almond	PB	Portobello	461	Graphite
CL	Caramel	PT	Portico	462	Cinder
CW	Cordovan	SK	Skyline	478	Platinum Grey
DW	Judicial	SM	Sonoma	488	Frosty White
HN2	Honey 2	TF	Truffle	491	Designer White Linear
IM	Brighton	405	Designer White	492	Cinder Linear
MC	Amber	419	Wallaby	792	Sable
MH	Mocha	425	Shadow	793	Acorn

GALLERY PVC SOFTENED RIM

Grade 1 – 5% upcharge	
G1001	Citadel
G1011	Pepperdust
Grade 2 – 6% upcharge	
G1002	Planked Raw Oak
G1003	Evening Notte
G1004	Kirsche
G1005	Midnight Run
G1006	Sepia Walnut
G1007	Serotina
G1008	Timeless
G1009	White Nebbia
G1012	Phantom Ecu

BASE LEGS PAINT COLORS

405	Designer White
423	Concrete
462	Cinder
463	Iron
501	Platinum Metallic
503	Satin Nickel Metallic

SOLID SURFACE TOP OPTIONS

COLORS

7101	Bisque (Grade A)
7201	Glacier White (Grade A)
7202	Canyon (Grade B)
7203	Designer White (Grade B)
7204	Silt (Grade B)
7301	Concrete (Grade C)
7302	Deep Night Sky (Grade C)
7303	Deep Nocturne (Grade C)

RIM PROFILE



WIXLER OCCASIONAL TABLES

PRODUCT SPECIFICATIONS

- Wood, laminate, glass, and solid surface available. See page 523 for options
- Upholstered top available. See pages 10-17 for fabric options
- Legs are solid wood. See page 523 for color options
- Legs shipped in same box as top (KD)
- Wood and laminate have a plywood core with exposed rim detail. Glass has plywood core, but not exposed
- Wood and laminate available with standard core with 3mm edge detail

TO ORDER, SPECIFY:

1. Model Number
2. Laminate/Wood Color
3. Solid Surface Grade (Solid surface only)
4. Solid Surface Color (Solid surface only)
5. Leg Finish

SAMPLE MODEL NUMBER:

88NA4216TRDW CW 463

- See page 523 for all options available in Occasional Tables

	MODEL NO./DESCRIPTION	LIST PRICE			DIMENSIONS					CARTONED CUBIC		
		GRADE A	GRADE B	GRADE C	D	W	H	A	KW	WEIGHT	FEET	
	42" ROUND				DI	H						
	88NA4216TRDW	Wood	\$ 2078		42	—	16	—	—	61 lbs.	10.7	
	88NA4216TRDLW	Laminate	2078		42	—	16	—	—	61 lbs.	10.7	
	88NA4216TRDGW	White Back Painted Glass	4013		42	—	16	—	—	109 lbs.	10.7	
	88NA4216TRDSW	Solid Surface	4165	4508	4949	42	—	16	—	—	86 lbs.	10.7
	88NA4216TRDVW	Wood 3mm Rim	1715			42	—	16	—	—	61 lbs.	10.7
	88NA4216TRDVLW	Laminate 3mm Rim	1456			42	—	16	—	—	61 lbs.	10.7
	<hr/>											
	88NA4218TRDW	Wood	\$ 2105			42	—	18	—	—	62 lbs.	10.7
	88NA4218TRDLW	Laminate	2105			42	—	18	—	—	62 lbs.	10.7
	88NA4218TRDGW	White Back Painted Glass	4040			42	—	18	—	—	110 lbs.	10.7
	88NA4218TRDSW	Solid Surface	4192	4535	4976	42	—	18	—	—	87 lbs.	10.7
	88NA4218TRDVW	Wood 3mm Rim	1742			42	—	18	—	—	62 lbs.	10.7
	88NA4218TRDVLW	Laminate 3mm Rim	1483			42	—	18	—	—	62 lbs.	10.7
	<hr/>											
	36" ROUND											
	88NA3616TRDW	Wood	\$ 1988			36	—	16	—	—	47 lbs.	8.2
	88NA3616TRDLW	Laminate	1988			36	—	16	—	—	47 lbs.	8.2
88NA3616TRDGW	White Back Painted Glass	3491			36	—	16	—	—	83 lbs.	8.2	
88NA3616TRDSW	Solid Surface	3784	4036	4360	36	—	16	—	—	66 lbs.	8.2	
88NA3616TRDVW	Wood 3mm Rim	1607			36	—	16	—	—	47 lbs.	8.2	
88NA3616TRDVLW	Laminate 3mm Rim	1348			36	—	16	—	—	47 lbs.	8.2	
<hr/>												
88NA3618TRDW	Wood	\$ 2016			36	—	18	—	—	49 lbs.	8.2	
88NA3618TRDLW	Laminate	2016			36	—	18	—	—	49 lbs.	8.2	
88NA3618TRDGW	White Back Painted Glass	3518			36	—	18	—	—	84 lbs.	8.2	
88NA3618TRDSW	Solid Surface	3811	4063	4387	36	—	18	—	—	67 lbs.	8.2	
88NA3618TRDVW	Wood 3mm Rim	1634			36	—	18	—	—	49 lbs.	8.2	
88NA3618TRDVLW	Laminate 3mm Rim	1375			36	—	18	—	—	49 lbs.	8.2	

- Ships as one unit (KD)
- All models except for the wood and laminate 3mm have a reversed half-bullnose rim detail

WIXLER OCCASIONAL TABLES

PRODUCT SPECIFICATIONS

- Wood, laminate, glass, and solid surface available. See page 523 for options
- Upholstered top available. See pages 10-17 for fabric options
- Legs are solid wood. See page 523 for color options
- Legs shipped in same box as top (KD)
- Wood and laminate have a plywood core with exposed rim detail. Glass has plywood core, but not exposed
- Wood and laminate available with standard core with 3mm edge detail

TO ORDER, SPECIFY:

1. Model Number
2. Laminate/Wood Color
3. Solid Surface Grade (Solid surface only)
4. Solid Surface Color (Solid surface only)
5. Leg Finish

SAMPLE MODEL NUMBER:

88NA2416TRDW CW 463

- See page 523 for all options available in Occasional Tables

MODEL NO./DESCRIPTION	LIST PRICE			DIMENSIONS					CARTONED CUBIC		
	GRADE A	GRADE B	GRADE C	D	W	H	A	KW	WEIGHT	FEET	
24" ROUND				DI	H						
88NA2416TRDW Wood	\$ 1853			24	—	16	—	—	25 lbs.	4.2	
88NA2416TRDLW Laminate	1853			24	—	16	—	—	25 lbs.	4.2	
88NA2416TRDGW White Back Painted Glass	2707			24	—	16	—	—	41 lbs.	4.2	
88NA2416TRDSW Solid Surface	3216	3328	3472	24	—	16	—	—	33 lbs.	4.2	
88NA2416TRDVW Wood 3mm Rim	1499			24	—	16	—	—	25 lbs.	4.2	
88NA2416TRDVLW Laminate 3mm Rim	1240			24	—	16	—	—	25 lbs.	4.2	
Grade	1	2/COM	3/COL	4	5	6	7	L7	L8		
88NA2417TRDFW Fabric	\$ 1907	1931	1941	1959	1978	2011	2054	2259	2326		

ROUND TOP (CONTINUED)



ALLIANCE GRADE / LIST PRICE

	A	B	C	D	E	F	G	H	I	J
\$	1948	1972	1991	2011	2034	2058	2077	2101	2127	2150
	K	L	M	N	O	P	Q	R	S	T
\$	2189	2266	2314	2339	2365	2389	2415	2438	2463	2488

DIMENSIONS

Diameter	24	Weight	25
Height	17	Cubic Ft.	4.2

88NA2418TRDW Wood	\$ 1880				24	—	18	—	—	26 lbs.	4.2
88NA2418TRDLW Laminate	1880				24	—	18	—	—	26 lbs.	4.2
88NA2418TRDGW White Back Painted Glass	2734				24	—	18	—	—	42 lbs.	4.2
88NA2418TRDSW Solid Surface	3243	3355	3499		24	—	18	—	—	35 lbs.	4.2
88NA2418TRDVW Wood 3mm Rim	1526				24	—	18	—	—	26 lbs.	4.2
88NA2418TRDVLW Laminate 3mm Rim	1267				24	—	18	—	—	26 lbs.	4.2
Grade	1	2/COM	3/COL	4	5	6	7	L7	L8		
88NA2419TRDFW Fabric	\$ 1934	1958	1968	1986	2005	2038	2081	2286	2353		

ALLIANCE GRADE / LIST PRICE

	A	B	C	D	E	F	G	H	I	J
\$	1975	1999	2018	2038	2061	2085	2104	2128	2154	2177
	K	L	M	N	O	P	Q	R	S	T
\$	2216	2293	2341	2366	2392	2416	2442	2465	2490	2515

DIMENSIONS

Diameter	24	Weight	26
Height	19	Cubic Ft.	4.2

- Ships as one unit (KD)
- All models except for the wood and laminate 3mm have a reversed half-bullnose rim detail

WIXLER OCCASIONAL TABLES

PRODUCT SPECIFICATIONS

- Wood, laminate, glass, and solid surface available. See page 523 for options
- Upholstered top available. See pages 10-17 for fabric options
- Legs are solid wood. See page 523 for color options
- Legs shipped in same box as top (KD)
- Wood and laminate have a plywood core with exposed rim detail. Glass has plywood core, but not exposed
- Wood and laminate available with standard core with 3mm edge detail

TO ORDER, SPECIFY:

1. Model Number
2. Laminate/Wood Color
3. Solid Surface Grade (Solid surface only)
4. Solid Surface Color (Solid surface only)
5. Leg Finish

SAMPLE MODEL NUMBER:

88NA2420TRDW CW 463

- See page 523 for all options available in Occasional Tables

MODEL NO./DESCRIPTION	LIST PRICE			DIMENSIONS					CARTONED CUBIC	
	GRADE A	GRADE B	GRADE C	D	W	H	A	KW	WEIGHT	FEET
ROUND TOP (CONTINUED)										
										
24" ROUND										
88NA2420TRDW Wood	\$	1907		24	—	20	—	—	28 lbs.	4.2
88NA2420TRDLW Laminate		1907		24	—	20	—	—	28 lbs.	4.2
88NA2420TRDGW White Back Painted Glass		2761		24	—	20	—	—	43 lbs.	4.2
88NA2420TRDSW Solid Surface		3270	3382	3526	24	—	20	—	36 lbs.	4.2
88NA2420TRDVW Wood 3mm Rim		1553			24	—	20	—	28 lbs.	4.2
88NA2420TRDVLW Laminate 3mm Rim		1294			24	—	20	—	28 lbs.	4.2
24" ROUND (Continued)										
88NA2422TRDW Wood	\$	1934			24	—	22	—	29 lbs.	4.2
88NA2422TRDLW Laminate		1934			24	—	22	—	29 lbs.	4.2
88NA2422TRDGW White Back Painted Glass		2788			24	—	22	—	45 lbs.	4.2
88NA2422TRDSW Solid Surface		3297	3409	3553	24	—	22	—	37 lbs.	4.2
88NA2422TRDVW Wood 3mm Rim		1580			24	—	22	—	29 lbs.	4.2
88NA2422TRDVLW Laminate 3mm Rim		1321			24	—	22	—	29 lbs.	4.2
18" ROUND										
88NA1816TRDW Wood	\$	1763			18	—	16	—	19 lbs.	3.1
88NA1816TRDLW Laminate		1763			18	—	16	—	19 lbs.	3.1
88NA1816TRDGW White Back Painted Glass		2185			18	—	16	—	28 lbs.	3.1
88NA1816TRDSW Solid Surface		2834	2896	2975	18	—	16	—	24 lbs.	3.1
88NA1816TRDVW Wood 3mm Rim		1390			18	—	16	—	19 lbs.	3.1
88NA1816TRDVLW Laminate 3mm Rim		1132			18	—	16	—	19 lbs.	3.1
Grade		1	2/COM	3/COL	4	5	6	7	L7	L8
88NA1817TRDFW Fabric	\$	1817	1836	1844	1858	1872	1898	1931	2091	2143

ALLIANCE GRADE / LIST PRICE

	A	B	C	D	E	F	G	H	I	J
\$	1849	1867	1882	1898	1916	1935	1949	1968	1988	2006
	K	L	M	N	O	P	Q	R	S	T
\$	2036	2096	2133	2153	2173	2192	2212	2230	2250	2269

DIMENSIONS

Diameter	18	Weight	19
Height	17	Cubic Ft.	3.1

- Ships as one unit (KD)
- All models except for the wood and laminate 3mm have a reversed half-bullnose rim detail

WIXLER OCCASIONAL TABLES

PRODUCT SPECIFICATIONS

- Wood, laminate, glass, and solid surface available. See page 523 for options
- Upholstered top available. See pages 10-17 for fabric options
- Legs are solid wood. See page 523 for color options
- Legs shipped in same box as top (KD)
- Wood and laminate have a plywood core with exposed rim detail. Glass has plywood core, but not exposed
- Wood and laminate available with standard core with 3mm edge detail

TO ORDER, SPECIFY:

1. Model Number
2. Laminate/Wood Color
3. Solid Surface Grade (Solid surface only)
4. Solid Surface Color (Solid surface only)
5. Leg Finish

SAMPLE MODEL NUMBER:

88NA1818TRDW CW 463

- See page 523 for all options available in Occasional Tables

MODEL NO./DESCRIPTION	LIST PRICE			DIMENSIONS					CARTONED CUBIC			
	DI	W	H	A	KW	WEIGHT	FEET					
18" ROUND												
88NA1818TRDW Wood			GRADE A	GRADE B	GRADE C	18	—	18	—	—	21 lbs.	3.1
88NA1818TRDLW Laminate			1790			18	—	18	—	—	21 lbs.	3.1
88NA1818TRDGW White Back Painted Glass			2212			18	—	18	—	—	29 lbs.	3.1
88NA1818TRDSW Solid Surface			2861	2923	3002	18	—	18	—	—	25 lbs.	3.1
88NA1818TRDVW Wood 3mm Rim			1418			18	—	18	—	—	21 lbs.	3.1
88NA1818TRDVLW Laminate 3mm Rim			1159			18	—	18	—	—	21 lbs.	3.1
Grade			1	2/COM	3/COL	4	5	6	7	L7	L8	
88NA1819TRDFW Fabric		\$	1844	1863	1871	1885	1899	1925	1958	2118	2170	

ROUND TOP (CONTINUED)



ALLIANCE GRADE / LIST PRICE

	A	B	C	D	E	F	G	H	I	J
\$	1876	1894	1909	1925	1943	1962	1976	1995	2015	2033
	K	L	M	N	O	P	Q	R	S	T
\$	2063	2123	2160	2180	2200	2219	2239	2257	2277	2296

DIMENSIONS

Diameter	18	Weight	21
Height	19	Cubic Ft.	3.1

88NA1820TRDW Wood	\$	1817				18	—	20	—	—	23 lbs.	3.4
88NA1820TRDLW Laminate		1817				18	—	20	—	—	23 lbs.	3.4
88NA1820TRDGW White Back Painted Glass		2239				18	—	20	—	—	32 lbs.	3.4
88NA1820TRDSW Solid Surface		2888	2950	3029		18	—	20	—	—	28 lbs.	3.4
88NA1820TRDVW Wood 3mm Rim		1445				18	—	20	—	—	23 lbs.	3.4
88NA1820TRDVLW Laminate 3mm Rim		1186				18	—	20	—	—	23 lbs.	3.4
88NA1822TRDW Wood	\$	1844				18	—	22	—	—	25 lbs.	3.7
88NA1822TRDLW Laminate		1844				18	—	22	—	—	25 lbs.	3.7
88NA1822TRDGW White Back Painted Glass		2266				18	—	22	—	—	34 lbs.	3.7
88NA1822TRDSW Solid Surface		2915	2977	3056		18	—	22	—	—	30 lbs.	3.7
88NA1822TRDVW Wood 3mm Rim		1472				18	—	22	—	—	25 lbs.	3.7
88NA1822TRDVLW Laminate 3mm Rim		1213				18	—	22	—	—	25 lbs.	3.7

- Ships as one unit (KD)
- All models except for the wood and laminate 3mm have a reversed half-bullnose rim detail

WIXLER OCCASIONAL TABLES

PRODUCT SPECIFICATIONS

- Wood, laminate, glass, and solid surface available. See page 523 for options
- Upholstered top available. See pages 10-17 for fabric options
- Legs are solid wood. See page 523 for color options
- Legs shipped in same box as top (KD)
- Wood and laminate have a plywood core with exposed rim detail. Glass has plywood core, but not exposed
- Wood and laminate available with standard core with 3mm edge detail

TO ORDER, SPECIFY:

1. Model Number
2. Laminate/Wood Color
3. Solid Surface Grade (Solid surface only)
4. Solid Surface Color (Solid surface only)
5. Leg Finish

SAMPLE MODEL NUMBER:

88NA424216TSQLW SM 503

- See page 523 for all options available in Occasional Tables

	MODEL NO./DESCRIPTION	LIST PRICE			DIMENSIONS					CARTONED CUBIC	
		D	W	H	A	KW	WEIGHT	FEET			
	42" SQUARE	GRADE A	GRADE B	GRADE C							
	88NA424216TSQW Wood	\$ 2078			42	42	16	—	—	72 lbs.	10.7
	88NA424216TSQLW Laminate	2078			42	42	16	—	—	72 lbs.	10.7
	88NA424216TSQGW White Back Painted Glass	4013			42	42	16	—	—	133 lbs.	10.7
	88NA424216TSQSW Solid Surface	4165	4508	4949	42	42	16	—	—	104 lbs.	10.7
	88NA424216TSQVW Wood 3mm Rim	1715			42	42	16	—	—	72 lbs.	10.7
	88NA424216TSQVLW Laminate 3mm Rim	1456			42	42	16	—	—	72 lbs.	10.7
	88NA424218TSQW Wood	\$ 2105			42	42	18	—	—	73 lbs.	10.7
	88NA424218TSQLW Laminate	2105			42	42	18	—	—	73 lbs.	10.7
	88NA424218TSQGW White Back Painted Glass	4040			42	42	18	—	—	134 lbs.	10.7
	88NA424218TSQSW Solid Surface	4192	4535	4976	42	42	18	—	—	105 lbs.	10.7
	88NA424218TSQVW Wood 3mm Rim	1742			42	42	18	—	—	73 lbs.	10.7
	88NA424218TSQVLW Laminate 3mm Rim	1483			42	42	18	—	—	73 lbs.	10.7
	36" SQUARE										
	88NA363616TSQW Wood	\$ 1988			36	36	16	—	—	55 lbs.	8.2
	88NA363616TSQLW Laminate	1988			36	36	16	—	—	55 lbs.	8.2
	88NA363616TSQGW White Back Painted Glass	3491			36	36	16	—	—	100 lbs.	8.2
	88NA363616TSQSW Solid Surface	3784	4036	4360	36	36	16	—	—	79 lbs.	8.2
	88NA363616TSQVW Wood 3mm Rim	1607			36	36	16	—	—	55 lbs.	8.2
	88NA363616TSQVLW Laminate 3mm Rim	1348			36	36	16	—	—	55 lbs.	8.2
88NA363618TSQW Wood	\$ 2016			36	36	18	—	—	57 lbs.	8.2	
88NA363618TSQLW Laminate	2016			36	36	18	—	—	57 lbs.	8.2	
88NA363618TSQGW White Back Painted Glass	3518			36	36	18	—	—	102 lbs.	8.2	
88NA363618TSQSW Solid Surface	3811	4063	4387	36	36	18	—	—	80 lbs.	8.2	
88NA363618TSQVW Wood 3mm Rim	1634			36	36	18	—	—	57 lbs.	8.2	
88NA363618TSQVLW Laminate 3mm Rim	1375			36	36	18	—	—	57 lbs.	8.2	

- Ships as one unit (KD)
- All models except for the wood and laminate 3mm have a reversed half-bullnose rim detail

PRODUCT SPECIFICATIONS

- Wood, laminate, glass, and solid surface available. See page 523 for options
- Upholstered top available. See pages 10-17 for fabric options
- Legs are solid wood. See page 523 for color options
- Legs shipped in same box as top (KD)
- Wood and laminate have a plywood core with exposed rim detail. Glass has plywood core, but not exposed
- Wood and laminate available with standard core with 3mm edge detail

TO ORDER, SPECIFY:

1. Model Number
2. Laminate/Wood Color
3. Solid Surface Grade (Solid surface only)
4. Solid Surface Color (Solid surface only)
5. Leg Finish

SAMPLE MODEL NUMBER:

88NA242416TSQLW SM 503

- See page 523 for all options available in Occasional Tables

SOFT SQUARE TOP (CONTINUED)



MODEL NO./DESCRIPTION	LIST PRICE			DIMENSIONS					CARTONED CUBIC	
	GRADE A	GRADE B	GRADE C	D	W	H	A	KW	WEIGHT	FEET
24" SQUARE										
88NA242416TSQW Wood	\$ 1853			24	24	16	—	—	29 lbs.	4.2
88NA242416TSQLW Laminate	1853			24	24	16	—	—	29 lbs.	4.2
88NA242416TSQGW White Back Painted Glass	2707			24	24	16	—	—	49 lbs.	4.2
88NA242416TSQSW Solid Surface	3216	3328	3472	24	24	16	—	—	39 lbs.	4.2
88NA242416TSQVW Wood 3mm Rim	1499			24	24	16	—	—	29 lbs.	4.2
88NA242416TSQVLW Laminate 3mm Rim	1240			24	24	16	—	—	29 lbs.	4.2
Grade	1	2/COM	3/COL	4	5	6	7	L7	L8	
88NA242417TSQFW Fabric	\$ 1907	1931	1941	1959	1978	2011	2054	2259	2326	

ALLIANCE GRADE / LIST PRICE

	A	B	C	D	E	F	G	H	I	J
\$	1948	1972	1991	2011	2034	2058	2077	2101	2127	2150
	K	L	M	N	O	P	Q	R	S	T
\$	2189	2266	2314	2339	2365	2389	2415	2438	2463	2488

DIMENSIONS

Depth	24	Weight	29
Width	24	Cubic Ft.	4.2
Height	17		

88NA242418TSQW Wood	\$ 1880			24	24	18	—	—	30 lbs.	4.2
88NA242418TSQLW Laminate	1880			24	24	18	—	—	30 lbs.	4.2
88NA242418TSQGW White Back Painted Glass	2734			24	24	18	—	—	40 lbs.	4.2
88NA242418TSQSW Solid Surface	3243	3355	3499	24	24	18	—	—	40 lbs.	4.2
88NA242418TSQVW Wood 3mm Rim	1526			24	24	18	—	—	30 lbs.	4.2
88NA242418TSQVLW Laminate 3mm Rim	1267			24	24	18	—	—	30 lbs.	4.2
Grade	1	2/COM	3/COL	4	5	6	7	L7	L8	
88NA242419TSQFW Fabric	\$ 1934	1958	1968	1986	2005	2038	2081	2286	2353	

ALLIANCE GRADE / LIST PRICE

	A	B	C	D	E	F	G	H	I	J
\$	1975	1999	2018	2038	2061	2085	2104	2128	2154	2177
	K	L	M	N	O	P	Q	R	S	T
\$	2216	2293	2341	2366	2392	2416	2442	2465	2490	2515

DIMENSIONS

Depth	24	Weight	30
Width	24	Cubic Ft.	4.2
Height	19		

- Ships as one unit (KD)
- All models except for the wood and laminate 3mm have a reversed half-bullnose rim detail

WIXLER OCCASIONAL TABLES

PRODUCT SPECIFICATIONS

- Wood, laminate, glass, and solid surface available. See page 523 for options
- Upholstered top available. See pages 10-17 for fabric options
- Legs are solid wood. See page 523 for color options
- Legs shipped in same box as top (KD)
- Wood and laminate have a plywood core with exposed rim detail. Glass has plywood core, but not exposed
- Wood and laminate available with standard core with 3mm edge detail

TO ORDER, SPECIFY:

1. Model Number
2. Laminate/Wood Color
3. Solid Surface Grade (Solid surface only)
4. Solid Surface Color (Solid surface only)
5. Leg Finish

SAMPLE MODEL NUMBER:

88NA242420TSQSW A 7201 501

- See page 523 for all options available in Occasional Tables

MODEL NO./DESCRIPTION	LIST PRICE			DIMENSIONS					CARTONED CUBIC	
	GRADE A	GRADE B	GRADE C	D	W	H	A	KW	WEIGHT	FEET
SOFT SQUARE TOP (CONTINUED)										
										
24" SQUARE										
88NA242420TSQW Wood	\$ 1907			24	24	20	—	—	31 lbs.	4.2
88NA242420TSQLW Laminate	1907			24	24	20	—	—	31 lbs.	4.2
88NA242420TSQGW White Back Painted Glass	2761			24	24	20	—	—	51 lbs.	4.2
88NA242420TSQSW Solid Surface	3270	3382	3526	24	24	20	—	—	42 lbs.	4.2
88NA242420TSQVW Wood 3mm Rim	1553			24	24	20	—	—	31 lbs.	4.2
88NA242420TSQVLW Laminate 3mm Rim	1294			24	24	20	—	—	31 lbs.	4.2
24" SQUARE										
88NA242422TSQW Wood	\$ 1934			24	24	22	—	—	33 lbs.	4.2
88NA242422TSQLW Laminate	1934			24	24	22	—	—	33 lbs.	4.2
88NA242422TSQGW White Back Painted Glass	2788			24	24	22	—	—	53 lbs.	4.2
88NA242422TSQSW Solid Surface	3297	3409	3553	24	24	22	—	—	43 lbs.	4.2
88NA242422TSQVW Wood 3mm Rim	1580			24	24	22	—	—	33 lbs.	4.2
88NA242422TSQVLW Laminate 3mm Rim	1321			24	24	22	—	—	33 lbs.	4.2
18" SQUARE										
88NA181816TSQW Wood	\$ 1763			18	18	16	—	—	21 lbs.	3.1
88NA181816TSQLW Laminate	1763			18	18	16	—	—	21 lbs.	3.1
88NA181816TSQGW White Back Painted Glass	2185			18	18	16	—	—	33 lbs.	3.1
88NA181816TSQSW Solid Surface	2834	2896	2975	18	18	16	—	—	27 lbs.	3.1
88NA181816TSQVW Wood 3mm Rim	1390			18	18	16	—	—	21 lbs.	3.1
88NA181816TSQVLW Laminate 3mm Rim	1132			18	18	16	—	—	21 lbs.	3.1
Grade	1	2/COM	3/COL	4	5	6	7	L7	L8	
88NA181817TSQFW Fabric	\$ 1817	1836	1844	1858	1872	1898	1931	2091	2143	

ALLIANCE GRADE / LIST PRICE

	A	B	C	D	E	F	G	H	I	J
\$	1849	1867	1882	1898	1916	1935	1949	1968	1988	2006
	K	L	M	N	O	P	Q	R	S	T
\$	2036	2096	2133	2153	2173	2192	2212	2230	2250	2269

DIMENSIONS

Depth	18	Weight	21
Width	18	Cubic Ft.	3.1
Height	17		

- Ships as one unit (KD)
- All models except for the wood and laminate 3mm have a reversed half-bullnose rim detail

WIXLER OCCASIONAL TABLES

PRODUCT SPECIFICATIONS

- Wood, laminate, glass, and solid surface available. See page 523 for options
- Upholstered top available. See pages 10-17 for fabric options
- Legs are solid wood. See page 523 for color options
- Legs shipped in same box as top (KD)
- Wood and laminate have a plywood core with exposed rim detail. Glass has plywood core, but not exposed
- Wood and laminate available with standard core with 3mm edge detail

TO ORDER, SPECIFY:

1. Model Number
2. Laminate/Wood Color
3. Solid Surface Grade (Solid surface only)
4. Solid Surface Color (Solid surface only)
5. Leg Finish

SAMPLE MODEL NUMBER:

88NA181820TSQSW A 7201 501

- See page 523 for all options available in Occasional Tables

MODEL NO./DESCRIPTION	LIST PRICE				DIMENSIONS					CARTONED CUBIC	
	GRADE A	GRADE B	GRADE C		D	W	H	A	KW	WEIGHT	FEET
SOFT SQUARE TOP (CONTINUED)	18" SQUARE										
88NA181818TSQW Wood	\$ 1790				18	18	18	—	—	23 lbs.	3.1
88NA181818TSQLW Laminate	1790				18	18	18	—	—	23 lbs.	3.1
88NA181818TSQGW White Back Painted Glass	2212				18	18	18	—	—	34 lbs.	3.1
88NA181818TSQSW Solid Surface	2861	2923	3002		18	18	18	—	—	29 lbs.	3.1
88NA181818TSQVW Wood 3mm Rim	1418				18	18	18	—	—	23 lbs.	3.1
88NA181818TSQVLW Laminate 3mm Rim	1159				18	18	18	—	—	23 lbs.	3.1
Grade	1	2/COM	3/COL	4	5	6	7	L7	L8		
88NA181819TSQFW Fabric	\$ 1844	1863	1871	1885	1899	1925	1958	2118	2170		



ALLIANCE GRADE / LIST PRICE

	A	B	C	D	E	F	G	H	I	J
\$	1876	1894	1909	1925	1943	1962	1976	1995	2015	2033
	K	L	M	N	O	P	Q	R	S	T
\$	2063	2123	2160	2180	2200	2219	2239	2257	2277	2296

DIMENSIONS

Depth	18	Weight	23
Width	18	Cubic Ft.	3.1
Height	19		

88NA181820TSQW Wood	\$ 1817				18	18	20	—	—	25 lbs.	3.4
88NA181820TSQLW Laminate	1817				18	18	20	—	—	25 lbs.	3.4
88NA181820TSQGW White Back Painted Glass	2239				18	18	20	—	—	36 lbs.	3.4
88NA181820TSQSW Solid Surface	2888	2950	3029		18	18	20	—	—	31 lbs.	3.4
88NA181820TSQVW Wood 3mm Rim	1445				18	18	20	—	—	25 lbs.	3.4
88NA181820TSQVLW Laminate 3mm Rim	1186				18	18	20	—	—	25 lbs.	3.4
88NA181822TSQW Wood	\$ 1844				18	18	22	—	—	24 lbs.	3.6
88NA181822TSQLW Laminate	1844				18	18	22	—	—	24 lbs.	3.6
88NA181822TSQGW White Back Painted Glass	2266				18	18	22	—	—	36 lbs.	3.6
88NA181822TSQSW Solid Surface	2915	2977	3056		18	18	22	—	—	30 lbs.	3.6
88NA181822TSQVW Wood 3mm Rim	1472				18	18	22	—	—	24 lbs.	3.6
88NA181822TSQVLW Laminate 3mm Rim	1213				18	18	22	—	—	24 lbs.	3.6

- Ships as one unit (KD)
- All models except for the wood and laminate 3mm have a reversed half-bullnose rim detail

WIXLER OCCASIONAL TABLES

PRODUCT SPECIFICATIONS

- Wood, laminate, glass, and solid surface available. See page 523 for options
- Legs are solid wood. See page 523 for color options
- Legs shipped in same box as top (KD)
- Wood and laminate have a plywood core with exposed rim detail. Glass has plywood core, but not exposed
- Wood and laminate available with standard core with 3mm edge detail

TO ORDER, SPECIFY:

1. Model Number
2. Laminate/Wood Color
3. Solid Surface Grade (Solid surface only)
4. Solid Surface Color (Solid surface only)
5. Leg Finish

SAMPLE MODEL NUMBER:

88NA306016TRTVW PB 463

- See page 523 for all options available in Occasional Tables

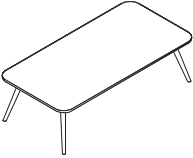
	MODEL NO./DESCRIPTION	LIST PRICE			DIMENSIONS					CARTONED CUBIC		
		GRADE A	GRADE B	GRADE C	D	W	H	A	KW	WEIGHT	FEET	
SOFT RECTANGLE TOP 	30" X 60"											
	88NA306016TRTW	Wood	\$ 2224			30	60	16	—	—	74 lbs.	11.0
	88NA306016TRLW	Laminate	2224			30	60	16	—	—	74 lbs.	11.0
	88NA306016TRTGW	White Back Painted Glass	3703			30	60	16	—	—	136 lbs.	11.0
	88NA306016TRTSW	Solid Surface	4074	4410	4842	30	60	16	—	—	106 lbs.	11.0
	88NA306016TRTVW	Wood 3mm Rim	1816			30	60	16	—	—	74 lbs.	11.0
	88NA306016TRTVLW	Laminate 3mm Rim	1557			30	60	16	—	—	74 lbs.	11.0
	<hr/>											
	88NA306018TRTW	Wood	\$ 2251			30	60	18	—	—	75 lbs.	11.0
	88NA306018TRLW	Laminate	2251			30	60	18	—	—	75 lbs.	11.0
	88NA306018TRTGW	White Back Painted Glass	3730			30	60	18	—	—	138 lbs.	11.0
	88NA306018TRTSW	Solid Surface	4101	4437	4869	30	60	18	—	—	108 lbs.	11.0
	88NA306018TRTVW	Wood 3mm Rim	1843			30	60	18	—	—	75 lbs.	11.0
	88NA306018TRTVLW	Laminate 3mm Rim	1584			30	60	18	—	—	75 lbs.	11.0
	<hr/>											
	24" X 48"											
	88NA244816TRTW	Wood	\$ 2004			24	48	16	—	—	50 lbs.	7.4
	88NA244816TRLW	Laminate	2004			24	48	16	—	—	50 lbs.	7.4
88NA244816TRTGW	White Back Painted Glass	3181			24	48	16	—	—	90 lbs.	7.4	
88NA244816TRTSW	Solid Surface	3692	3913	4198	24	48	16	—	—	71 lbs.	7.4	
88NA244816TRTVW	Wood 3mm Rim	1596			24	48	16	—	—	50 lbs.	7.4	
88NA244816TRTVLW	Laminate 3mm Rim	1336			24	48	16	—	—	50 lbs.	7.4	
<hr/>												
88NA244818TRTW	Wood	\$ 2031			24	48	18	—	—	51 lbs.	7.4	
88NA244818TRLW	Laminate	2031			24	48	18	—	—	51 lbs.	7.4	
88NA244818TRTGW	White Back Painted Glass	3208			24	48	18	—	—	92 lbs.	7.4	
88NA244818TRTSW	Solid Surface	3719	3940	4225	24	48	18	—	—	72 lbs.	7.4	
88NA244818TRTVW	Wood 3mm Rim	1623			24	48	18	—	—	51 lbs.	7.4	
88NA244818TRTVLW	Laminate 3mm Rim	1363			24	48	18	—	—	51 lbs.	7.4	

- Ships as one unit (KD)
- All models except for the wood and laminate 3mm have a reversed half-bullnose rim detail

WIXLER OCCASIONAL TABLES

PRODUCT SPECIFICATIONS

- Wood, laminate, glass, and solid surface available. See page 523 for options
- Legs are solid wood. See page 523 for color options
- Legs shipped in same box as top (KD)
- Wood and laminate have a plywood core with exposed rim detail. Glass has plywood core, but not exposed
- Wood and laminate available with standard core with 3mm edge detail

TO ORDER, SPECIFY:

1. Model Number
2. Laminate/Wood Color
3. Solid Surface Grade (Solid surface only)
4. Solid Surface Color (Solid surface only)
5. Leg Finish

SAMPLE MODEL NUMBER:

88NA183618TRTVW PB 463

- See page 523 for all options available in Occasional Tables

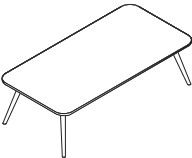
	MODEL NO./DESCRIPTION	LIST PRICE			DIMENSIONS					CARTONED CUBIC		
		GRADE A	GRADE B	GRADE C	D	W	H	A	KW	WEIGHT	FEET	
SOFT RECTANGLE TOP (CONTINUED) 	18" X 36"											
	88NA183616TRTW Wood	\$ 1785			18	36	16	—	—	32 lbs.	4.6	
	88NA183616TRTLW Laminate	1785			18	36	16	—	—	32 lbs.	4.6	
	88NA183616TRTGW White Back Painted Glass	2658			18	36	16	—	—	54 lbs.	4.6	
	88NA183616TRTSW Solid Surface	3309	3432	3591	18	36	16	—	—	43 lbs.	4.6	
	88NA183616TRTVW Wood 3mm Rim	1515			18	36	16	—	—	32 lbs.	4.6	
	88NA183616TRTVLW Laminate 3mm Rim	1255			18	36	16	—	—	32 lbs.	4.6	
	<hr/>											
	88NA183618TRTW Wood	\$ 1812			18	36	18	—	—	33 lbs.	4.6	
	88NA183618TRTLW Laminate	1812			18	36	18	—	—	33 lbs.	4.6	
	88NA183618TRTGW White Back Painted Glass	2685			18	36	18	—	—	55 lbs.	4.6	
	88NA183618TRTSW Solid Surface	3336	3459	3618	18	36	18	—	—	45 lbs.	4.6	
88NA183618TRTVW Wood 3mm Rim	1542			18	36	18	—	—	33 lbs.	4.6		
88NA183618TRTVLW Laminate 3mm Rim	1282			18	36	18	—	—	33 lbs.	4.6		
<hr/>												
88NA183620TRTW Wood	\$ 1839			18	36	20	—	—	35 lbs.	5.1		
88NA183620TRTLW Laminate	1839			18	36	20	—	—	35 lbs.	5.1		
88NA183620TRTGW White Back Painted Glass	2712			18	36	20	—	—	58 lbs.	5.1		
88NA183620TRTSW Solid Surface	3363	3486	3645	18	36	20	—	—	47 lbs.	5.1		
88NA183620TRTVW Wood 3mm Rim	1569			18	36	20	—	—	35 lbs.	5.1		
88NA183620TRTVLW Laminate 3mm Rim	1309			18	36	20	—	—	35 lbs.	5.1		
<hr/>												
88NA183622TRTW Wood	\$ 1866			18	36	22	—	—	37 lbs.	5.4		
88NA183622TRTLW Laminate	1866			18	36	22	—	—	37 lbs.	5.4		
88NA183622TRTGW White Back Painted Glass	2739			18	36	22	—	—	59 lbs.	5.4		
88NA183622TRTSW Solid Surface	3390	3513	3672	18	36	22	—	—	48 lbs.	5.4		
88NA183622TRTVW Wood 3mm Rim	1596			18	36	22	—	—	37 lbs.	5.4		
88NA183622TRTVLW Laminate 3mm Rim	1336			18	36	22	—	—	37 lbs.	5.4		

- Ships as one unit (KD)
- All models except for the wood and laminate 3mm have a reversed half-bullnose rim detail

WIXLER OCCASIONAL TABLES

PRODUCT SPECIFICATIONS

- Wood, laminate, glass, and solid surface available. See page 523 for options
- Upholstered top available. See pages 10-17 for fabric options
- Legs are solid wood. See page 523 for color options
- Legs shipped in same box as top (KD)
- Wood and laminate have a plywood core with exposed rim detail. Glass has plywood core, but not exposed
- Wood and laminate available with standard core with 3mm edge detail

TO ORDER, SPECIFY:

1. Model Number
2. Laminate/Wood Color
3. Solid Surface Grade (Solid surface only)
4. Solid Surface Color (Solid surface only)
5. Leg Finish

SAMPLE MODEL NUMBER:

88NA182416TRTLW 488 402

- See page 523 for all options available in Occasional Tables

MODEL NO./DESCRIPTION	LIST PRICE				DIMENSIONS					CARTONED CUBIC	
	GRADE A	GRADE B	GRADE C		D	W	H	A	KW	WEIGHT	FEET
SOFT RECTANGLE TOP (CONTINUED)	18" X 24"										
88NA182416TRTW Wood	\$ 1644				18	24	16	—	—	22 lbs.	3.3
88NA182416TRTLW Laminate	1644				18	24	16	—	—	22 lbs.	3.3
88NA182416TRTGW White Back Painted Glass	2518				18	24	16	—	—	37 lbs.	3.3
88NA182416TRTSW Solid Surface	3169	3250	3355		18	24	16	—	—	30 lbs.	3.3
88NA182416TRTVW Wood 3mm Rim	1434				18	24	16	—	—	22 lbs.	3.3
88NA182416TRTVLW Laminate 3mm Rim	1174				18	24	16	—	—	22 lbs.	3.3
Grade	1	2/COM	3/COL	4	5	6	7	L7	L8		
88NA182417TRTFW Fabric	\$ 1698	1717	1725	1739	1753	1779	1812	1972	2024		

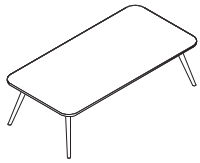

ALLIANCE GRADE / LIST PRICE

	A	B	C	D	E	F	G	H	I	J
\$	1730	1748	1763	1779	1797	1816	1830	1849	1869	1887
	K	L	M	N	O	P	Q	R	S	T
\$	1917	1977	2014	2034	2054	2073	2093	2111	2131	2150

DIMENSIONS

Depth	18	Weight	22
Width	24	Cubic Ft.	3.3
Height	17		

88NA182418TRTW Laminate	\$ 1671				18	24	18	—	—	24 lbs.	3.3
88NA182418TRTLW Laminate	1671				18	24	18	—	—	24 lbs.	3.3
88NA182418TRTGW White Back Painted Glass	2545				18	24	18	—	—	39 lbs.	3.3
88NA182418TRTSW Solid Surface	3196	3277	3382		18	24	18	—	—	32 lbs.	3.3
88NA182418TRTVW Wood 3mm Rim	1461				18	24	18	—	—	24 lbs.	3.3
88NA182418TRTVLW Laminate 3mm Rim	1201				18	24	18	—	—	24 lbs.	3.3
Grade	1	2/COM	3/COL	4	5	6	7	L7	L8		
88NA182419TRTFW Fabric	\$ 1752	1771	1779	1793	1807	1833	1866	2026	2078		

ALLIANCE GRADE / LIST PRICE

	A	B	C	D	E	F	G	H	I	J
\$	1784	1802	1817	1833	1851	1870	1884	1903	1923	1941
	K	L	M	N	O	P	Q	R	S	T
\$	1971	2031	2068	2088	2108	2127	2147	2165	2185	2204

DIMENSIONS

Depth	18	Weight	24
Width	24	Cubic Ft.	3.3
Height	19		

- Ships as one unit (KD)
- All models except for the wood and laminate 3mm have a reversed half-bullnose rim detail

WIXLER OCCASIONAL TABLES

PRODUCT SPECIFICATIONS

- Wood, laminate, glass, and solid surface available. See page 523 for options
- Legs are solid wood. See page 523 for color options
- Legs shipped in same box as top (KD)
- Wood and laminate have a plywood core with exposed rim detail. Glass has plywood core, but not exposed
- Wood and laminate available with standard core with 3mm edge detail

TO ORDER, SPECIFY:

1. Model Number
2. Laminate/Wood Color
3. Solid Surface Grade (Solid surface only)
4. Solid Surface Color (Solid surface only)
5. Leg Finish

SAMPLE MODEL NUMBER:

88NA182420TRTLW 488 402

- See page 523 for all options available in Occasional Tables

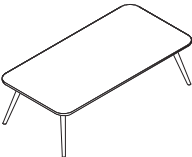
	MODEL NO./DESCRIPTION	LIST PRICE			DIMENSIONS					CARTONED CUBIC		
		GRADE A	GRADE B	GRADE C	D	W	H	A	KW	WEIGHT	FEET	
SOFT RECTANGLE TOP (CONTINUED) 	18" X 24"											
	88NA182420TRTW Wood	\$ 1698			18	24	20	—	—	28 lbs.	3.6	
	88NA182420TRLW Laminate	1698			18	24	20	—	—	28 lbs.	3.6	
	88NA182420TRTGW White Back Painted Glass	2572			18	24	20	—	—	43 lbs.	3.6	
	88NA182420TRTSW Solid Surface	3223	3304	3409	18	24	20	—	—	36 lbs.	3.6	
	88NA182420TRTVW Wood 3mm Rim	1488			18	24	20	—	—	28 lbs.	3.6	
	88NA182420TRTVLW Laminate 3mm Rim	1228			18	24	20	—	—	28 lbs.	3.6	
	<hr/>											
	88NA182422TRTW Wood	\$ 1725			18	24	22	—	—	27 lbs.	3.9	
	88NA182422TRLW Laminate	1725			18	24	22	—	—	27 lbs.	3.9	
	88NA182422TRTGW White Back Painted Glass	2599			18	24	22	—	—	42 lbs.	3.9	
	88NA182422TRTSW Solid Surface	3250	3331	3436	18	24	22	—	—	35 lbs.	3.9	
	88NA182422TRTVW Wood 3mm Rim	1515			18	24	22	—	—	27 lbs.	3.9	
	88NA182422TRTVLW Laminate 3mm Rim	1255			18	24	22	—	—	27 lbs.	3.9	

- Ships as one unit (KD)
- All models except for the wood and laminate 3mm have a reversed half-bullnose rim detail

WIXLER OCCASIONAL TABLES

PRODUCT SPECIFICATIONS

- Wood, laminate, glass, and solid surface available. See page 523 for options
- Legs are solid wood. See page 523 for color options
- Legs shipped in same box as top (KD)
- Wood and laminate have a plywood core with exposed rim detail. Glass has plywood core, but not exposed
- Wood and laminate available with standard core with 3mm edge detail

TO ORDER, SPECIFY:

1. Model Number
2. Laminate/Wood Color
3. Solid Surface Grade (Solid surface only)
4. Solid Surface Color (Solid surface only)
5. Leg Finish

SAMPLE MODEL NUMBER:

88NA304816TTRLW 488 402

- See page 523 for all options available in Occasional Tables

	MODEL NO./DESCRIPTION	LIST PRICE			DIMENSIONS					CARTONED CUBIC			
		GRADE A	GRADE B	GRADE C	D	W	H	A	KW	WEIGHT	FEET		
	30" X 48"												
	88NA304816TTRW	Wood	\$ 1924			30	48	16	—	—	45 lbs.	15.0	
	88NA304816TTRLW	Laminate	1924			30	48	16	—	—	45 lbs.	15.0	
	88NA304816TTRGW	White Back Painted Glass	3395			30	48	16	—	—	78 lbs.	15.0	
	88NA304816TTRSW	Solid Surface	3821	4093	4442	30	48	16	—	—	62 lbs.	15.0	
	88NA304816TTRVW	Wood 3mm Rim	1516			30	48	16	—	—	45 lbs.	15.0	
	88NA304816TTRVLW	Laminate 3mm Rim	1256			30	48	16	—	—	45 lbs.	15.0	
	88NA304818TTRW	Wood	\$ 1951			30	48	18	—	—	46 lbs.	9.0	
	88NA304818TTRLW	Laminate	1951			30	48	18	—	—	46 lbs.	9.0	
	88NA304818TTRGW	White Back Painted Glass	3422			30	48	18	—	—	79 lbs.	9.0	
	88NA304818TTRSW	Solid Surface	3848	4120	4469	30	48	18	—	—	63 lbs.	9.0	
	88NA304818TTRVW	Wood 3mm Rim	1543			30	48	18	—	—	46 lbs.	9.0	
	88NA304818TTRVLW	Laminate 3mm Rim	1283			30	48	18	—	—	46 lbs.	9.0	
	24" X 36"												
	88NA243616TTRW	Wood	\$ 1712			24	36	16	—	—	31 lbs.	5.8	
	88NA243616TTRLW	Laminate	1712			24	36	16	—	—	31 lbs.	5.8	
88NA243616TTRGW	White Back Painted Glass	2858			24	36	16	—	—	52 lbs.	5.8		
88NA243616TTRSW	Solid Surface	3392	3554	3763	24	36	16	—	—	42 lbs.	5.8		
88NA243616TTRVW	Wood 3mm Rim	1412			24	36	16	—	—	31 lbs.	5.8		
88NA243616TTRVLW	Laminate 3mm Rim	1153			24	36	16	—	—	31 lbs.	5.8		
88NA243618TTRW	Wood	\$ 1739			24	36	18	—	—	32 lbs.	11.0		
88NA243618TTRLW	Laminate	1739			24	36	18	—	—	32 lbs.	11.0		
88NA243618TTRGW	White Back Painted Glass	2885			24	36	18	—	—	53 lbs.	11.0		
88NA243618TTRSW	Solid Surface	3420	3582	3791	24	36	18	—	—	43 lbs.	11.0		
88NA243618TTRVW	Wood 3mm Rim	1439			24	36	18	—	—	32 lbs.	11.0		
88NA243618TTRVLW	Laminate 3mm Rim	1180			24	36	18	—	—	32 lbs.	11.0		

- Ships as one unit (KD)
- All models except for the wood and laminate 3mm have a reversed half-bullnose rim detail

WIXLER OCCASIONAL TABLES

PRODUCT SPECIFICATIONS

- Wood, laminate, glass, and solid surface available. See page 523 for options
- Upholstered top available. See pages 10-17 for fabric options
- Legs are solid wood. See page 523 for color options
- Legs shipped in same box as top (KD)
- Wood and laminate have a plywood core with exposed rim detail. Glass has plywood core, but not exposed
- Wood and laminate available with standard core with 3mm edge detail

TO ORDER, SPECIFY:

1. Model Number
2. Laminate/Wood Color
3. Solid Surface Grade (Solid surface only)
4. Solid Surface Color (Solid surface only)
5. Leg Finish

SAMPLE MODEL NUMBER:

88NA284816TPRLW 488 402

- See page 523 for all options available in Occasional Tables

	MODEL NO./DESCRIPTION	LIST PRICE			DIMENSIONS					CARTONED CUBIC	
		GRADE A	GRADE B	GRADE C	D	W	H	A	KW	WEIGHT	FEET
	28" X 48"										
	88NA284816TPRW Wood	\$ 1978			28	48	16	—	—	47 lbs.	8.5
	88NA284816TPRLW Laminate	1978			28	48	16	—	—	47 lbs.	8.5
	88NA284816TPRGW White Back Painted Glass	3449			28	48	16	—	—	83 lbs.	8.5
	88NA284816TPRSW Solid Surface	3875	4130	4457	28	48	16	—	—	66 lbs.	8.5
	88NA284816TPRVW Wood 3mm Rim	1570			28	48	16	—	—	47 lbs.	8.5
	88NA284816TPRVLW Laminate 3mm Rim	1310			28	48	16	—	—	47 lbs.	8.5
	88NA284818TPRW Wood	\$ 2005			28	48	18	—	—	48 lbs.	8.5
	88NA284818TPRLW Laminate	2005			28	48	18	—	—	48 lbs.	8.5
	88NA284818TPRGW White Back Painted Glass	3476			28	48	18	—	—	84 lbs.	8.5
	88NA284818TPRSW Solid Surface	3902	4157	4484	28	48	18	—	—	67 lbs.	8.5
	88NA284818TPRVW Wood 3mm Rim	1597			28	48	18	—	—	48 lbs.	8.5
	88NA284818TPRVLW Laminate 3mm Rim	1337			28	48	18	—	—	48 lbs.	8.5
	24" X 36"										
	88NA243616TPRW Wood	\$ 1766			24	36	16	—	—	32 lbs.	5.8
	88NA243616TPRLW Laminate	1766			24	36	16	—	—	32 lbs.	5.8
	88NA243616TPRGW White Back Painted Glass	2912			24	36	16	—	—	54 lbs.	5.8
	88NA243616TPRSW Solid Surface	3447	3609	3818	24	36	16	—	—	44 lbs.	5.8
88NA243616TPRVW Wood 3mm Rim	1358			24	36	16	—	—	32 lbs.	5.8	
88NA243616TPRVLW Laminate 3mm Rim	1142			24	36	16	—	—	32 lbs.	5.8	
88NA243618TPRW Wood	\$ 1793			24	36	18	—	—	33 lbs.	5.8	
88NA243618TPRLW Laminate	1793			24	36	18	—	—	33 lbs.	5.8	
88NA243618TPRGW White Back Painted Glass	2939			24	36	18	—	—	55 lbs.	5.8	
88NA243618TPRSW Solid Surface	3474	3636	3845	24	36	18	—	—	45 lbs.	5.8	
88NA243618TPRVW Wood 3mm Rim	1385			24	36	18	—	—	33 lbs.	5.8	
88NA243618TPRVLW Laminate 3mm Rim	1169			24	36	18	—	—	33 lbs.	5.8	

- Ships as one unit (KD)
- All models except for the wood and laminate 3mm have a reversed half-bullnose rim detail

